

BlueShadow

Pump 80P Instructions



Document no. V7685

HPLC



Note: For your own safety, read the instructions and observe the warnings and safety information on the device and in the instructions. Keep the instructions for future reference.



Note: In case you require this instruction in another language, please submit your request including the corresponding document number via e-mail or fax to KNAUER.

Support: Do you have questions about the installation or the operation of your instrument or software?

International Support:

Contact your local KNAUER partner for support:

www.knauer.net/en/Support/Distributors-worldwide

Support in Germany

(Austria & Switzerland on case-to-case basis):

Phone: +49 30 809727-111 (workdays 9-17h CET)

Fax : +49 30 8015010

Email: support@knauer.net

Publisher: KNAUER Wissenschaftliche Geräte GmbH

Hegauer Weg 38

14163 Berlin

Germany

Phone: +49 30 809727-0

Fax: +49 30 8015010

Internet: www.knauer.net

E-Mail: info@knauer.net

Version information: Document number: V7685

Version number: 1.1

Release date: 2020/11/17

Translation of the original edition

The information in this document is subject to change without prior notice. For the latest version of the instructions, visit our website: www.knauer.net/library.



Sustainability: The printed versions of our instructions are printed according to Blue Angel standards (www.blauer-engel.de/en/uz195).

Copyright: This document contains confidential information and may not be reproduced without written consent of KNAUER Wissenschaftliche Geräte GmbH.

© KNAUER Wissenschaftliche Geräte GmbH 2020
All rights reserved.

Table of contents

1. General	1
1.1 About these instructions	1
1.2 Signal words	1
1.3 Additional typographical conventions	1
1.4 Legal information	2
1.4.1 Liability limitation	2
1.4.2 Transport damage	2
1.4.3 Warranty conditions	2
1.4.4 Warranty seal	2
1.4.5 Declaration of conformity	2
2. Basic safety instructions	3
2.1 Intended use	3
2.1.1 Operating ranges	3
2.1.2 Foreseeable misuse	3
2.2 User qualification	3
2.3 Operator responsibility	4
2.4 Personal safety equipment	4
2.5 Working with solvents	5
2.5.1 General requirements	5
2.5.2 Contamination by health-threatening solvents	5
2.5.3 Avoiding leakage	5
2.6 Specific environments	6
2.6.1 Earthquake-endangered areas	6
2.6.2 Explosive environment	6
2.6.3 Cooling room	6
2.6.4 Wet room	6
2.7 Maintenance, care and repair	6
2.8 Service request form and decontamination report	7
3. Product information	8
3.1 Intended use	8
3.2 Performance features	8
3.3 Device overview	9
3.4 Pump heads	10
3.5 Symbols and signs	11
3.6 Scope of delivery	11

4. Installation	12
4.1 Preparations	12
4.1.1 Operating location	12
4.1.2 Power supply	13
4.1.3 Unpacking the device	13
4.2 Connecting the piston backflushing	14
4.3 Eluent inlet	15
4.3.1 Connecting the eluent inlet to the pump head	16
4.3.2 Connecting the eluent line	17
4.4 Changing the setup to LPG	18
4.4.1 Valve block types	18
4.4.2 Connecting the LPG module	18
4.4.3 Controlling the LPG module	19
4.5 Control	19
4.5.1 Pin header connectors	20
4.5.2 Events connector	22
4.5.3 Connecting cables to the pin header	23
4.5.4 Connecting the device to a computer	24
4.5.5 Configuring the LAN settings	25
4.5.6 Connect devices to LAN	25
4.5.7 Configuring the router	26
4.5.8 Integrating the LAN into the company network	26
4.5.9 Controlling several systems separately in the LAN	26
4.5.10 Analog control	27
5. Operation	28
5.1 Switching on the pump	28
5.2 Configuring the LPG module	28
5.3 Purging the pump	28
5.3.1 Piston backflushing	29
5.4 Switch on and self test	30
5.5 Operating with LC display and keypad	30
5.5.1 LED status	31
5.5.2 RFID icon	31
5.5.3 Operating with the keypad	32
5.6 Menu structure	33
5.6.1 Main menu	33
5.6.2 Menu structure: overview	34
5.6.3 Device setting parameters	35
5.7 GLP menu	39
5.8 Program menu	39
5.8.1 Create program	39

5.8.2	Run program	40
5.8.3	Change program	40
5.8.4	Delete program lines	40
5.8.5	Delete a program	40
5.8.6	Create a program with a starting time	41
5.9	Link menu	41
5.9.1	Create link	41
5.9.2	Run link	42
5.9.3	Delete link	42
6.	Functionality tests	43
6.1	Installation Qualification (IQ)	43
6.2	Operation Qualification (OQ)	43
7.	Troubleshooting	44
7.1	LAN	44
7.2	Possible problems and solutions	45
7.3	System messages	46
8.	Maintenance and care	50
8.1	Maintenance contract	50
8.2	Cleaning and caring for the device	50
8.3	Checking the fittings	51
8.3.1	Torque values	51
8.3.2	Tighten fittings	51
8.4	Flushing the pump	51
8.5	Pump head	52
8.5.1	Dismounting the pump head	52
8.5.2	Installing the pump head	53
8.6	Check valves	54
8.6.1	Removing the check valves	54
8.6.2	Cleaning the check valve	55
8.6.3	Installing the check valve	55
9.	Transport and storage	56
9.1	Putting the pump out of operation	56
9.2	Packing the device	56
9.3	Transporting the device	56
9.4	Storing	56
9.4.1	Storing the device	56
9.4.2	Storing the pump head	57

10. Disposal	58
10.1 AVV-Marking Germany.....	58
10.2 WEEE registration number.....	58
10.3 Eluents and other operating materials.....	58
11. Technical data	59
11.1 Solvent delivery.....	59
11.2 Communication.....	60
11.3 General.....	60
12. Chemical compatibility of wetted materials	62
12.1 General.....	62
12.2 Plastics.....	62
12.3 Non-metals.....	64
12.4 Metals.....	65
13. Repeat orders	66
13.1 Devices.....	66
13.2 Spare parts.....	66

1. General

1.1 About these instructions

These operating instructions enable the safe and efficient operation of the device. The user must have carefully read and understood these operating instructions before starting any work.





The basic prerequisite for safe operation is compliance with all safety instructions (see chapter 2 on page 3). In addition to the safety and warning instructions in these operating instructions, the local accident prevention regulations and the national industrial safety regulations apply.

These operating instructions are an integral part of the device. It must be kept in the immediate vicinity of the device and accessible to the user at all times.

You can download these and other instructions from the KNAUER website: www.knauer.net/library

1.2 Signal words

Possible dangers related to the device are distinguished in personal and material damages.

Symbol	Meaning
	DANGER (red) indicates a highly hazardous situation. If not avoided, it will result in death or serious injury.
	WARNING (orange) indicates a hazardous situation. If not avoided, it could result in death or serious injury.
	CAUTION (yellow) indicates a moderate hazardous situation. If not avoided, it could result in minor or moderate injury.
	NOTICE (blue) is used to address issues which are not related to physical injury.

1.3 Additional typographical conventions

- General equal treatment: When persons are described, this document uses the male grammar form to keep the text easy to read. The form has a neutral sense and speaks to people of any gender in the same way.
- Note: Specific information are prefixed with the word "Note" and an information icon.

 **Note:** This is an example.

1.4 Legal information

1.4.1 Liability limitation

The manufacturer is not liable for the following issues:

- Non-compliance of these instructions
- Non-observance of necessary safety precautions
- Improper use
- Operation of the device by unqualified personnel (see chapter 2.2 on page 3)
- Use of non-approved spare parts
- Technical changes by the user such as opening the device and unauthorized modifications
- Violations of General Terms and Conditions (GTC)

1.4.2 Transport damage

The packaging of our devices provides the best possible protection against transport damage. However, check the packaging for transport damage. In case you notice any damage, inform the Technical Support and the shipping company within three workdays.

1.4.3 Warranty conditions

For information on warranty please refer to our general terms and conditions on the website: www.knauer.net/terms

1.4.4 Warranty seal

A blue or orange warranty seal is affixed to some devices.

- A blue seal is used by KNAUER's Manufacturing or Customer Support for devices to be sold.
- After repair, service technicians attach an orange seal onto the identical position.

After repair, the service technician affixes an orange seal in the same place. If unauthorised persons tamper with the device or if the seal is damaged, the warranty will lapse.



1.4.5 Declaration of conformity

The declaration of conformity is enclosed as a separate document with the product and can be obtained online:

www.knauer.net/en/Support/Declarations-of-conformity

2. Basic safety instructions

The device has been developed and constructed in such a way that hazards arising from its intended use are largely excluded. Nevertheless, the following safety instructions must be observed in order to exclude residual hazards.

2.1 Intended use

Only use the device for applications that fall within the range of the intended use. Otherwise, the protective and safety equipment of the device could fail.

2.1.1 Operating ranges

The device is intended to be used indoors for chromatographic applications.

2.1.2 Foreseeable misuse

Refrain from the use of the device for the following purposes or conditions:

- Medical purposes. The device is not approved as a medical product.
- Operating outdoors. Otherwise, the manufacturer does not guarantee the functionality and safety of the device.
- Operation in potentially explosive areas without special and additional explosion protection. Contact the KNAUER Customer Support for more information.

2.2 User qualification

The user is qualified to handle the device if all of the following points apply:

- He has at least a basic knowledge of liquid chromatography.
- He has knowledge about the properties of the used solvents and their health risks.
- He is trained for the special tasks and activities in the laboratory and knows the relevant standards and regulations.
- Due to his technical training and experience, he can understand and carry out all the work described in the operating instructions on the instrument and recognize and avoid possible dangers independently.
- His ability to react is not impaired by the consumption of drugs, alcohol or medication.
- Participation in the installation of a device or a training by the company KNAUER or an authorized company.

If the user does not meet these qualifications, he must inform his supervisor.

2.3 Operator responsibility

The operator is any person who operates the device himself or leaves it to a third party for use and who bears the legal product responsibility for the protection of the user or third parties during operation.

The obligations of the operator are listed below:

- Know and follow the applicable work safety regulations
- Identify hazards arising from the working conditions at the place of use in a risk assessment.
- Set up operating instructions for the operation of the device.
- Regularly check whether the operating instructions correspond to the current status of the regulations.
- Clearly regulate and specify responsibilities for installation, operation, troubleshooting, maintenance and cleaning and set clear rules
- Ensure that all personnel who work with the device have read and understood these operating instructions
- Train the personnel who work with the device at regular intervals and inform them about the dangers.
- Provide the necessary safety equipment to the employees working with the unit (see section below).

2.4 Personal safety equipment

The protective measures required in the laboratory must be observed and the following protective clothing worn during all work on the device:

- Safety glasses with side protection
- Protective gloves in accordance with the prevailing ambient conditions and used solvents (e.g. heat, cold, protection against chemicals).
- Lab coat
- Personalised protective safety equipment which is specified in the particular laboratory.

2.5 Working with solvents

2.5.1 General requirements

- The user is trained for handling different solvents.
- Note recommended solvents and concentrations in these instructions in order to avoid personal injury or damage to the device. For example, certain chemicals may cause PEEK capillaries to swell or burst (see chapter 12 on page 62).
- Note that organic solvents are toxic above a certain concentration. For handling hazardous solvents see the following section.
- Mobile phases and samples may contain volatile or combustible solvents. Avoid the accumulation of these substances. Ensure good ventilation of the installation site. Avoid open flames and sparks. Do not operate the instrument in the presence of flammable gases or vapors.
- Only use solvents which do not self-ignite under given conditions. This applies especially to the use of a thermostat where liquids could get onto hot surfaces in the interior.
- Degas solvents before use and observe their purity.

2.5.2 Contamination by health-threatening solvents

- Contamination with toxic, infectious or radioactive substances poses a hazard for all persons involved during operation, repair, sale, and disposal of a device.
- All contaminated devices must be properly decontaminated by a specialist company or the operating company before they can be recommissioned, repaired, sold, or disposed (see chapter 10 on page 58).

2.5.3 Avoiding leakage

Risk of electrical shock or short circuit if solvents or other liquids leak into the interior of the device. You can avoid a leakage through the following measures:

- Tightness: Visually check the device or system regularly for leaks.
- Solvent tray: The use of a solvent tray prevents liquids get from the bottles into the inside of the device.
- Eluent lines: Install capillaries and hoses in such a way that, in case of a leak, liquids cannot get into the interior of the devices underneath.
- In case of leakage: Switch off the system. Only take the device into operation if the cause of the leak has been resolved (see chapter 8 on page 50).

2.6 Specific environments

2.6.1 Earthquake-endangered areas

In earthquake-endangered areas, do not stack more than 3 devices on top of each other. Otherwise there is a risk of injury due to falling devices or loose parts.

2.6.2 Explosive environment

Never use the system in potentially explosive atmospheres without appropriate protective equipment. For more information, contact the KNAUER Customer Support.

2.6.3 Cooling room

You may operate the device in a cooling room. To prevent condensation, note the following instructions:

- Allow the device to acclimatize for min. 3 hours before taking it into operation.
- After taking into operation, the device should stay switched on.
- Avoid temperature fluctuations.

2.6.4 Wet room

The device must not be operated in wet rooms.

2.7 Maintenance, care and repair

- Avoiding electric shock: Before performing any maintenance and service work, disconnect the device from the power supply.
- Tools: Use only tools recommended or prescribed by the manufacturer.
- Spare parts and accessories: Only use original parts and accessories made by KNAUER or a company authorized by KNAUER.
- PEEK fittings: Use PEEK fittings only for a single port or brand-new PEEK fittings in order to avoid dead volume or not exactly fitting connections.
- Column care: Follow KNAUER or other manufacturer's instructions on caring for the columns (see www.knauer.net/columncare)
- Used capillaries: Do not use any used capillaries elsewhere in the system in order to avoid dead volumes, not exactly fitting connections and spreading contamination.
- Safety features: The device may only be opened by the KNAUER Customer Support of KNAUER or any company authorized by KNAUER (see chapter 1.4.1 on page 2).
- For more information visit the KNAUER website: www.knauer.net/hplc-troubleshooting

2.8 Service request form and decontamination report

Devices which are shipped without the completed document "Service request form and decontamination report" will not be repaired. If you would like to return a device to KNAUER, make sure to enclose the completed document: www.knauer.net/servicerequest

3. Product information



Note: Only use the device for applications that fall within the range of the intended use. Otherwise, the protective and safety equipment of the device could fail.

Automatic piston backflushing increases the service life of the seals and pistons, and removes salt and other substances from the area behind the seals.

Operating modes

Isocratic operation:

- Separation without gradients.
- The solvent composition is constant during the analysis.
- The solvent can be recycled.

Gradient operation:

- LPG (Low Pressure Gradient): The gradient is formed on the low-pressure side of the pump.
- HPG (High Pressure Gradient): The gradient is formed on the high-pressure side of the pump.

3.1 Intended use

The device or device system is suitable for high-pressure liquid chromatography. It is suitable for laboratory use, for separating substance mixtures that can be dissolved in a solvent or solvent mixture.

- Dosing pump
- Separation of substances
- Filtration of substances

3.2 Performance features

- Dual-piston technology
- Liquid transport with low pulsation, stable flow rate, and high flow accuracy
- Long service life
- Internal controlling for programming binary to quaternary high-pressure gradients
- HPG system: up to four pumps can be combined
- LPG system: Connection of a binary or ternary LPG valve block
- Ultra-precise gradient mixtures throughout entire flow range
- High physical and chemical stability
- Direct pump control via analog and digital signals
- Control with chromatography software

3.3 Device overview

Legend

- ① Display
- ② Pressure sensor
- ③ Venting screw
- ④ Keypad
- ⑤ Tube connections for the piston backflushing
- ⑥ Pump head

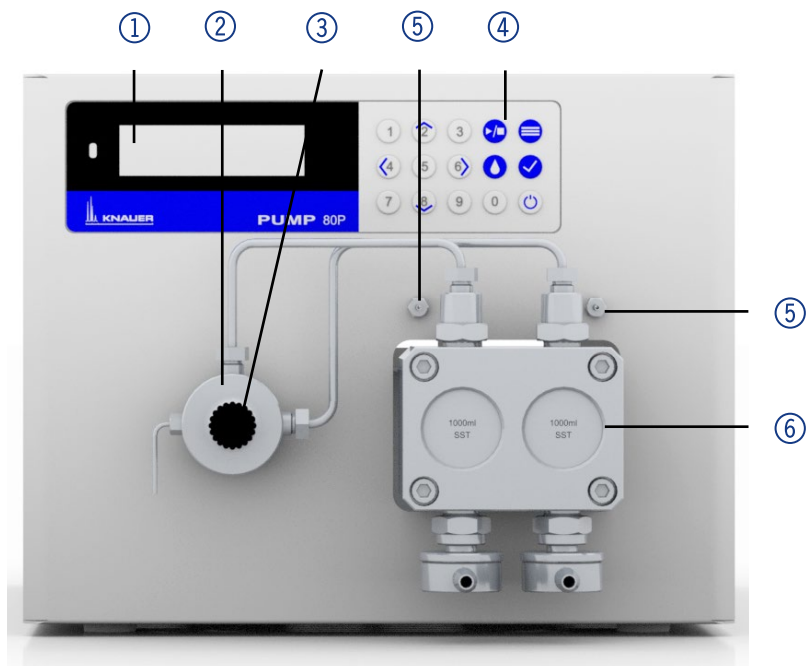

Fig. 1: Front view

Legend

- ① Socket for the LPG valve block
- ② Events connector
- ③ Opening of the fan
- ④ Warranty seal
- ⑤ Power switch
- ⑥ Power supply
- ⑦ CE-mark
- ⑧ Remote connector
- ⑨ Interface RS-232
- ⑩ LAN connection
- ⑪ Serial number

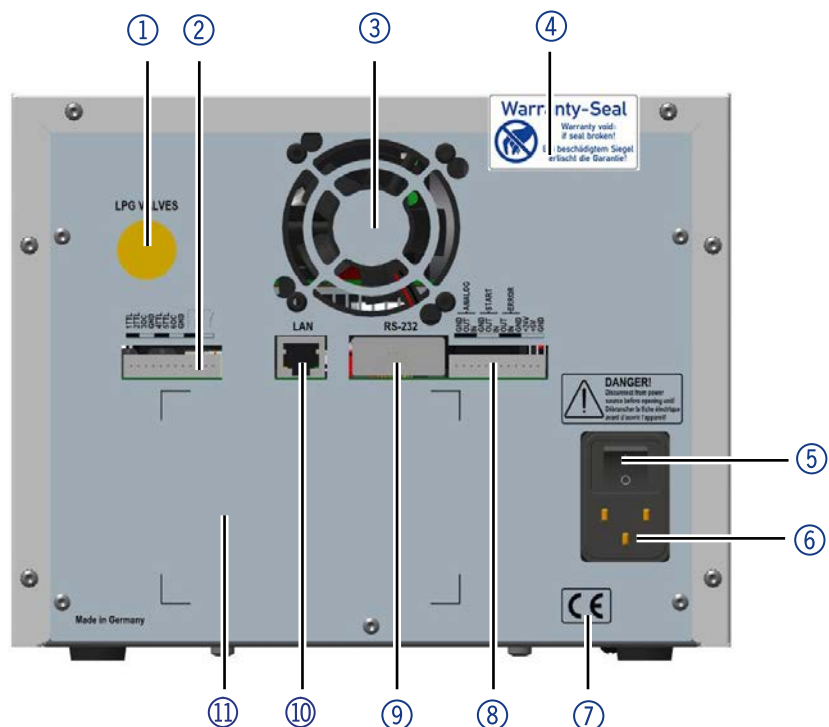

Fig. 2: Rear view

3.4 Pump heads

Pump head for use in preparative applications:

- Standard model, stainless steel
- Titanium inlays for biocompatible applications: 100 ml, 250 ml, 500 ml, 1000 ml

For biocompatibility, pump heads with titanium inlays can be used. The pump heads can be exchanged by the user.

Designation The front of the pump head is labeled with the maximum pumping capacity and the pump head inlays (**SSt** for stainless steel, **Ti** for titanium).



Fig.3: Pump head 500 ml, stainless steel





RFID detection The pump head is equipped with an RFID chip. It is used to monitor and save all important parameters and settings of the pump and pump head.

The RFID technology offers the following advantages:

- Automatic detection of all important pump head parameters by means of radio signals (radio frequency identification), by the pump software or the chromatography software:
 - Pump head type
 - Serial number and year of manufacture
 - Number of cycles and operating times
 - Limit values of the pump head parameters
- All measuring data archived in accordance with GLP (Good Laboratory Practice).
- Transfer of all data to the software and pump display.

3.5 Symbols and signs

The following symbols and signs can be found on the device:

Symbol	Meaning
	Electric shock hazard
	Electrostatic discharge hazard, damages to system, device, or components can occur.
	A device marked with CE fulfills the product specific requirements of European directives. This is confirmed in a Declaration of Conformity.
	Testing seals in Canada and the USA at nationally recognized testing centers (NRTL). The certified device or system has successfully passed the quality and security tests.
	A warranty seal is affixed to some devices. For more information see chap. 1.4.4 on p. 2.

3.6 Scope of delivery



Note: Only use original parts and accessories made by KNAUER or a company authorized by KNAUER.

- Power cable
- BlueShadow Pump 80P with pump head
- Accessories kit pump 80P
- Accessories kit pump head

Applicable documents:

- User manual
- Installation Qualification
- Declaration of Conformity

4. Installation

This chapter describes all preparatory steps prior to start-up.

4.1 Preparations

4.1.1 Operating location

The intended use be ensured only if the requirements for ambient conditions of the operating environment are met. You will find the ambient conditions under Technical Data.

NOTICE

Device defect

The device overheats at exposure to sunlight and insufficient air circulation. Device failures are very likely.

- Set up the device in such a way that it is protected against exposure to direct sunlight.
- Leave room for air circulation: See paragraph „space requirements“.

Space requirements

- At least 5 cm, if there is another device on one side.
- At least 10 cm, if there are devices set up on both sides.
- At least 15 cm to the cooler fan on the rear.
- Make sure that the power plug on the power supply (wall socket or power strip) is always accessible, so that the device can be disconnected from the power supply.

General purpose

- Position the device on a level surface.
- Protect the device against direct exposure to sunlight.
- Set up the device at a location not exposed to air drafts such as air conditioning systems.
- Do not set up the device near to other machines that cause floor vibrations.
- Keep the the devices away from high frequency sources. High frequencies may compromise measuring values.



Note: Make sure that the power plug on the rear of the device is always accessible, so that the device can be disconnected from the power supply.



Note: Avoid electrostatic discharges at the pump head.

Change of location

Observe the following when moving the device from a cooling room to a normal laboratory:

- Switch on the device before moving and leave switched on for ½ hour to warm up.
- As an alternative, allow the device to warm up in the laboratory for at least 3 hours and do not connect to the power supply during this duration to avoid damages by condensed water.

NOTICE**Device defect**

Changes of the environmental temperature cause condensation inside the device.

- Allow device to acclimate for 3 h before connecting to power supply and taking into operation.

4.1.2 Power supply

For power supply, use the supplied power cable and power adapter to meet the specifications which are described in the chapter Technical Data. But inspect the provided power cable beforehand to ensure that it is approved for your country. Replace defective power cables only with accessories from KNAUER. Detachable power supply cables are not allowed to be replaced with other cable types.

NOTICE**Electronic defect**

Electronic hazard when using an identically constructed power adapter from another manufacturer.

- Only use spare parts and accessories from KNAUER or a company authorized by KNAUER.

- | | |
|-------------------|--|
| Conditions | <ul style="list-style-type: none"> ■ The electrical power supply at the installation site must be connected directly to the nearest main power line. ■ The power must be free from ripple, residual current, voltage peaks and electromagnetic interference. ■ The connectors for the mains voltage are grounded accordingly. ■ The device receives sufficient power with reserve capacity |
| Power plug | <ul style="list-style-type: none"> ■ The device is intended for use with AC power networks of 100-240 V. ■ Make sure that the power plug on the power supply (wall socket or power strip) is always accessible, so that the device can be disconnected from the power supply. |

4.1.3 Unpacking the device

- | | |
|----------------------|---|
| Prerequisites | <ul style="list-style-type: none"> ■ Check the carton for damage caused during transportation. |
| Tools | <ul style="list-style-type: none"> ■ Utility knife |

⚠ CAUTION**Bruising danger**

Damage to the device by carrying or lifting it on protruding housing parts. The device may fall and thus cause injuries.

- Lift the device only centrally on the side of the housing.

Process

1. Set-up the package in such a way that you can read the label.
2. Using the utility knife, cut the adhesive tape and open the packaging.
3. Lift the foam padding. Take out the accessories kit and the manual.
4. Open the accessories kit and check the scope of delivery. In case any parts are missing, contact the Technical Support.
5. Clasp the device from below, lift it out of the packaging and place it on its feet. Do not hold onto the front cover.
6. Check the device for signs of damage that occurred during transport. In case any parts are missing, contact the Technical Support.
7. Set up the device at the operation site. Lift the foam padding.

Next steps Store packaging and keep the included packing list for repeat orders.

4.2 Connecting the piston backflushing

The pump is equipped with automatic piston backflushing. It increases the service life of the seals and pistons, and removes contaminants from the area behind the seals.

Functional principle The piston backflushing function automatically flushes the rear piston area of the pump head upon switch-on and in continuous operation.

- Upon switch-on: The rear piston area of the pump head is flushed automatically for 15 seconds.
- In continuous mode: The rear piston area of the pump head is flushed automatically every 30 minutes, for 15 seconds.

Process

1. Lead a tube from the solvent bottle to the flush pump's inlet ① and fasten.
2. Lead a tube from the flush pump's outlet ④ to the pump head's inlet ③ and fasten it.
3. Fasten a tube to the pump head's outlet ② and lead to the waste bottle.

Figure

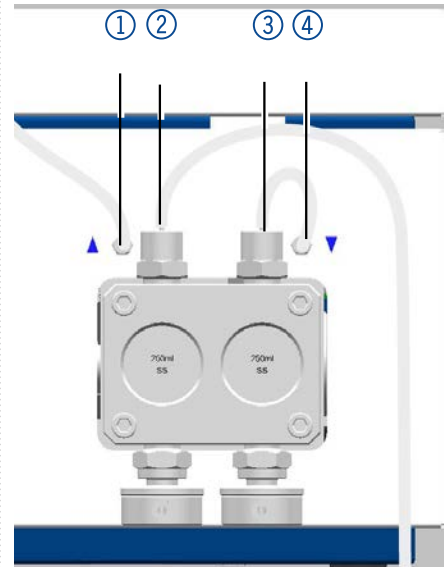

Fig.4: Connectors for piston backflushing

4.3 Eluent inlet



Note: The accessory Kit includes PTFE tubing and PETP bushing/sealing ring, which can be used for standard HPLC applications. For applications with aggressive solvents, PEEK or stainless steel parts are available.

The eluent lines are connected by the eluent inlet to the pump head.

Legend

- ① Knurled-head screw
- ② Eluent inlet

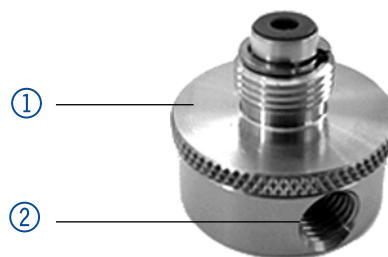

Fig.5: Connecting the eluent inlet to the pump head

4.3.1 Connecting the eluent inlet to the pump head

Process

1. With the knurled-head screw ②, screw the eluent inlet into the inlet screw fitting ① of the pump head.
2. Turn the eluent inlet until the intake manifold input ③ points forward.
3. Tighten the knurled-head screw.

Figure

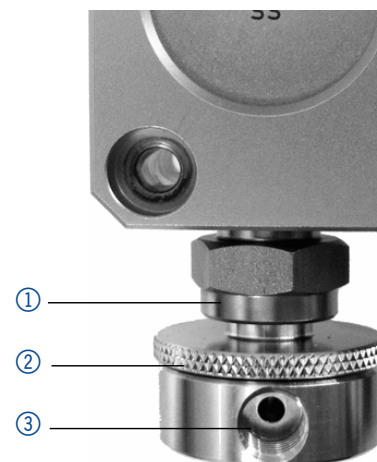

Fig. 6: Eluent inlet, variant 1



Fig. 7: Eluent inlet, variant 2

4.3.2 Connecting the eluent line

- Preparations**
- Make sure that all connections are tight.
 - Make sure that the tapered side of the cutting ring is pointed towards the fastening screw of the Teflon tube.

Pump head

- 100 ml
- 250 ml
- 500 ml

Process

1. Push the Teflon hose ① through the fastening screw ② and the cutting ring ③.
2. Insert the hose end as far as possible into the eluent inlet fitting ④ of the pump head.
3. Tighten the fastening screw by hand.

Figure

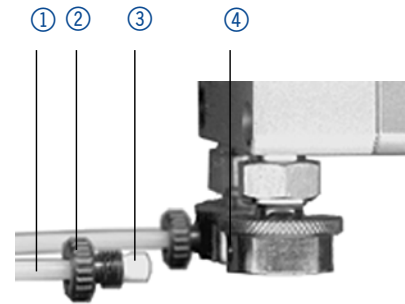

Fig. 8: Connecting the eluent line to the pump head

Pump head

- 1000 ml

Process

1. Push the Teflon hose directly on the olive-type tube fitting ①.
2. Fasten the Teflon hose with hose clamp.

Figure

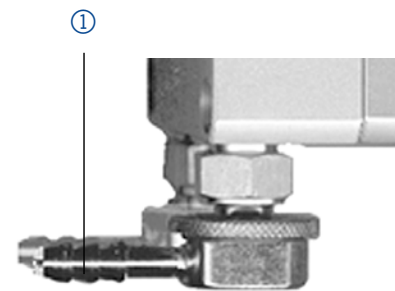

Fig. 9: Connecting the eluent line to the 1000 ml pump head

4.4 Changing the setup to LPG

The low-pressure gradient valve block (LPG valve block) supplements the pump to a low-pressure gradient system.

4.4.1 Valve block types

- Ternary LPG valve block for flow rates in the range of 2 - 220 ml/min
- Binary LPG valve block for flow rates in the range of 5 - 800 ml/min

Legend

- ① Ternary LPG valve block
- ② Fastening screws with sealing ring
- ③ Plug

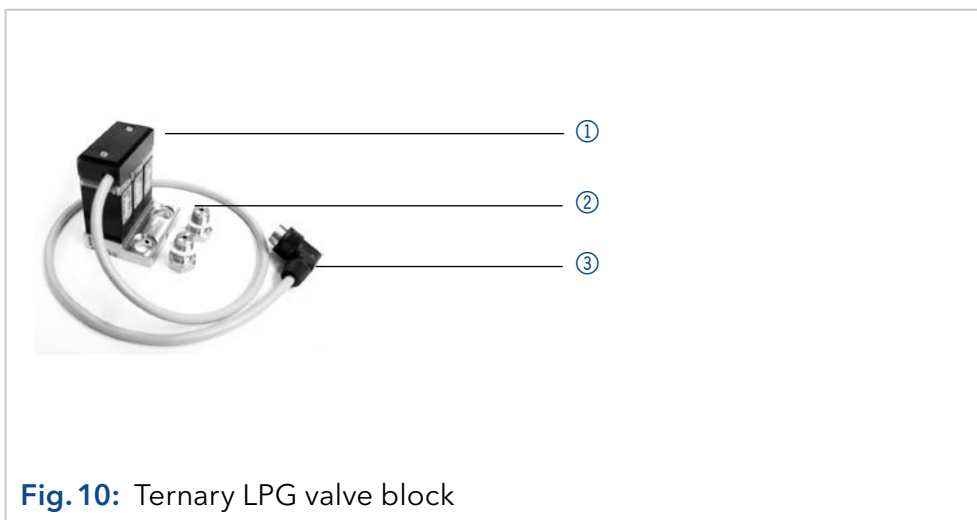

4.4.2 Connecting the LPG module



Note: Always place seals in pairs on both fastening screws.

Process

1. In the Setup menu, select Gradient type LPG ternary or otherwise LPG binary.
2. Switch off the pump and pull the power plug.
3. Unscrew the eluent inlets from the inlet screw fittings ③ of the pump head ①.
4. Screw tight LPG valve block ② with the fastening screws ④ and seals to the pump head.
5. Connect the eluent tubing to the inlets of the LPG valve block.
6. Plug a cap fitting into the unused inlet.

Figure

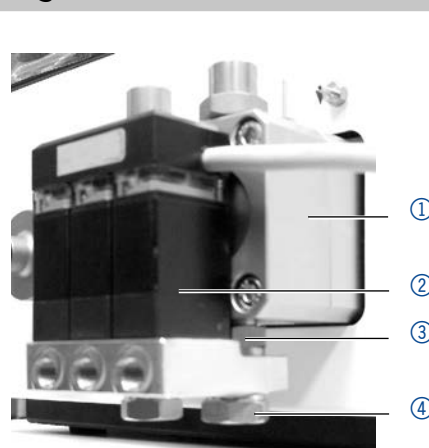

Fig. 11: Valve block connection

Process

Plug in the plug ⑤ in the socket ⑥ for LPG valve block on the rear of the pump.

Note: The plug ⑤ should not be detached during operation.

Figure

Fig. 12: Socket for the LPG valve block

4.4.3 Controlling the LPG module

- Manual control of the pump via keypad
- PC control with chromatography software

4.5 Control

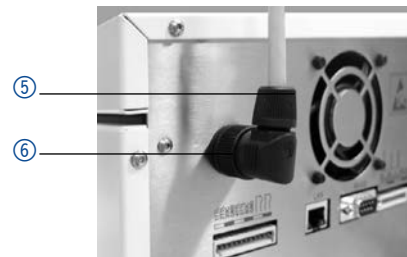
There are 3 ways to operate the pump:

- Via the pin head
- As part of a LAN, via the LAN connector of the router
- Operation on display

All connectors are located on the rear side of the detector.

Legend

- ① Socket for the LPG valve block
- ② Events connector
- ③ Remote connector
- ④ Interface RS-232
- ⑤ LAN connection

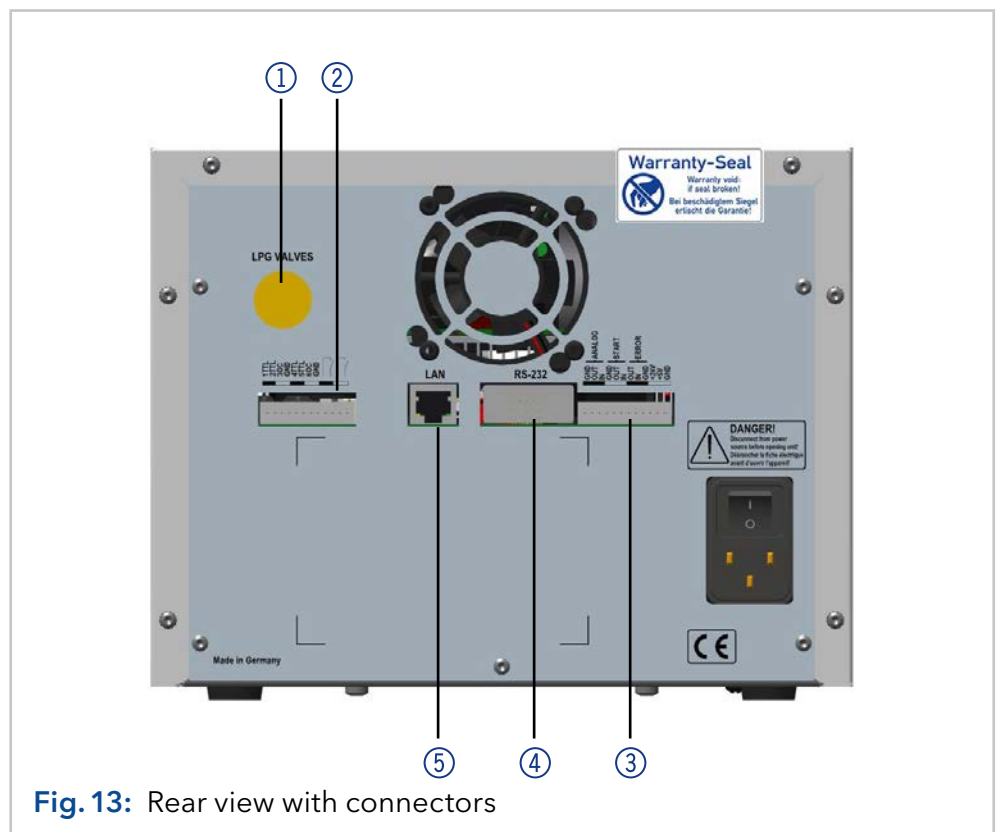















Fig. 13: Rear view with connectors

4.5.1 Pin header connectors

Connection	Function
1TTL	<p>TTL-compatible output</p> <p>Levels:</p> <ul style="list-style-type: none"> passive 0 V active 5 V <p>Pulse:</p> <p>5 V for at least 1000 ms</p>
2TTL	<p>TTL-compatible output</p> <p>Levels:</p> <ul style="list-style-type: none"> passive 0 V active 5 V <p>Pulse:</p> <ul style="list-style-type: none"> 5 V for at least 1000 ms
3OC	<p>TTL Output</p> <p>Levels:</p> <ul style="list-style-type: none"> passive 0 V active 5 V <p>Pulse:</p> <ul style="list-style-type: none"> 5 V for at least 1000 ms
GND	Reference point of the voltage at the signal inputs.
4TTL	<p>TTL-compatible output</p> <p>Levels:</p> <ul style="list-style-type: none"> passive 0 V active 5 V <p>Pulse:</p> <p>5 V for at least 1000 ms</p>
5TTL	<p>TTL-compatible output</p> <p>Levels:</p> <ul style="list-style-type: none"> passive 0 V active 5 V <p>Pulse:</p> <ul style="list-style-type: none"> 5 V for at least 1000 ms

Connection	Function
6OC	<p>TTL Output</p> <p>Levels:</p> <ul style="list-style-type: none"> passive 5 V  active 0 V  <p>Pulse:</p> <ul style="list-style-type: none"> 5 V for at least 1000 ms 
GND	Reference point of the voltage at the signal inputs.
	<p>Relay Contact</p> <p>The contact is on a floating basis. Its setting depends on the settings in the Control Unit or software.</p> <p>Steady-rate signal:</p> <ul style="list-style-type: none"> passive = open relay contact  active = closed relay contact  <p>Pulse:</p> <ul style="list-style-type: none"> Closed relay contact for at least 1000 ms <p>Permissible load of the relay contact: 1 A/ 24 V DC </p>
	<p>Relay Contact</p> <p>The contact is on a floating basis. Its setting depends on the settings in the Control Unit or software.</p> <p>Steady-rate signal:</p> <ul style="list-style-type: none"> passive = open relay contact  active = closed relay contact  <p>Pulse:</p> <ul style="list-style-type: none"> Closed relay contact for at least 1000 ms <p>Permissible load of the relay contact: 1 A/ 24 V DC </p>
Analog GND	Reference point of the voltage at the signal inputs.
Analog out	Voltage range 0 - 5 V, scalable
Analog in	Power range 0 - 10 V 10 V according to maximum flow rate
Start GND	Reference point of the voltage at the signal inputs.
Start OUT	<p>TTL Output</p> <p>Levels:</p> <ul style="list-style-type: none"> passive 5 V  active 0 V  <p>Output is active for 500 ms when a program starts.</p>

Connection	Function
Start IN	<p>TTL Input</p> <ul style="list-style-type: none"> Low-active <p>Secure switching threshold at least 10 mA</p> <p>After receiving a signal (short-circuit to ground) from an external device, the device starts. If controlled with software, an electronic trigger is send through the LAN.</p>
Error OUT	<p>TTL Output</p> <p>Levels:</p> <ul style="list-style-type: none"> passive 5 V active 0 V 
Error IN	<p>TTL Input</p> <ul style="list-style-type: none"> Low-active <p>Secure switching threshold at least 10 mA</p> <p>After receiving a signal (short-circuit to ground) from an external device, an error message appears and the device stops.</p> <p>The error is acknowledged via the keypad.</p>
Error GND	Reference point of the voltage at the signal inputs.
+24V	Event-controlled switching of 24 V against GND Protection: 24 V - 200 mA
+5V	Provides a voltage of 5 V with respect to GND. This makes it possible to supply a consumer that is switched by an EVENT. Protection: 5 V-50 mA
GND	Reference point of the voltage at the signal inputs.

4.5.2 Events connector

- **Sending control signals (Events)** to external devices
- opening and closing contacts
- activating 500 ms pulses

Symbol	Explanation
○	Off
●	On
⌋	Pulse

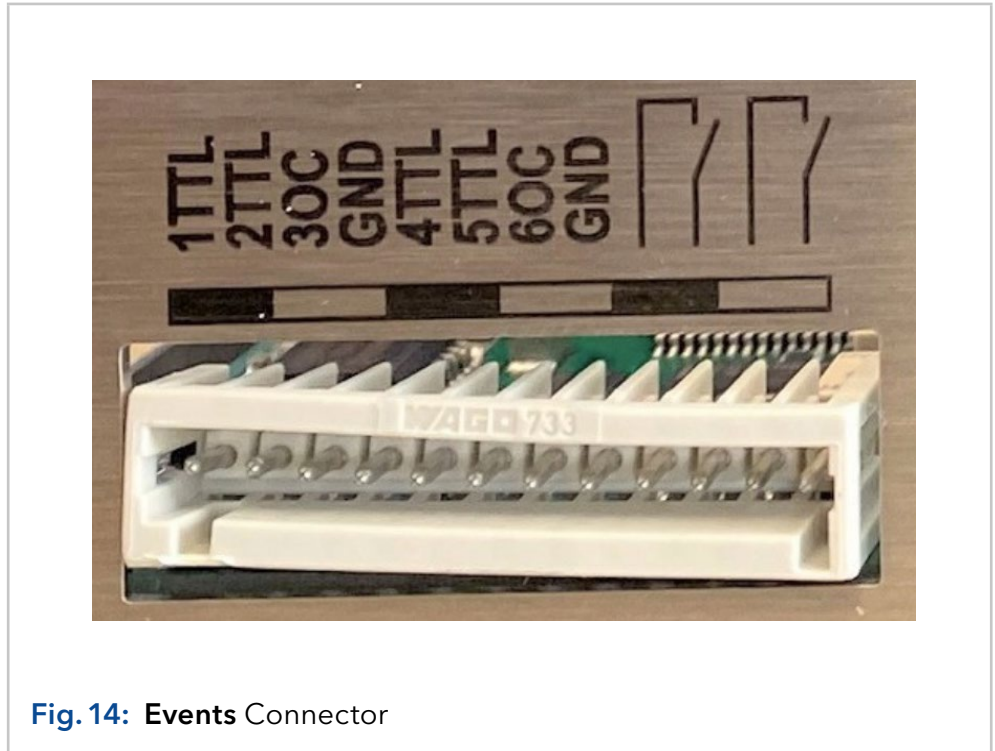

Fig. 14: Events Connector

4.5.3 Connecting cables to the pin header

To control one device through another, you use the pin header. To use remote control, you have to connect cables to the pin header. The single ports are used to exchange control signals.

- Prerequisites**
- The device is switched off.
 - The power plug has been disassembled from the device.
- Tools**
- Operating tool

NOTICE

Electronic defect

Connecting cables to the multi-pin connector of a switched on device causes a short circuit.

- Turn off the device before connecting cables.
- Pull the power plug.

NOTICE

Electronic defect

Electrostatic discharge can destroy the electronics.

- Wear a protective bracelet against electrostatic discharge and ground.

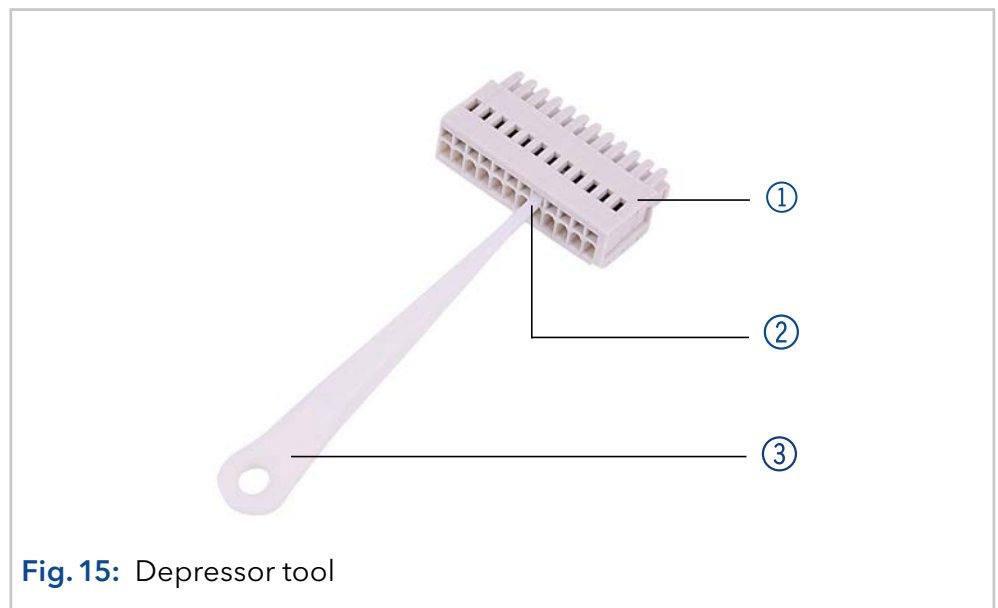

Fig. 15: Depressor tool

- Procedure**
1. Insert the depressor tool ③ in an upper small opening at the front of the pin header ①.
 2. Insert the cable into the opening ② underneath the inserted depressor tool.
 3. Pull out the depressor tool.

Next steps Check whether the cables are tightly attached. Press the pin header onto the plug. Finish the installation. Bring the device into operation.

4.5.4 Connecting the device to a computer



Note: HPLC devices from KNAUER only work with IP addresses, which have been assigned by IPv4. IPv6 is not supported.

This chapter describes how to set up a chromatography system in a local area network (LAN) and how a network administrator can integrate this LAN into your company network. The description applies to the operating system Windows® and all conventional routers.

To set up a LAN, we recommend to use a router. That means the following steps are required:

- Procedure**
1. On the computer, go to the control panel and check the LAN properties.
 2. Hook up the router to the devices and the computer.
 3. Set up the router for the computer network.
 4. Install the chromatography software.
 5. Switch on the device and run the chromatography software. Click on the button OK.

4.5.5 Configuring the LAN settings

The LAN uses only one server (which is normally the router) from that the devices automatically receive their IP address.

- Prerequisites**
- In Windows, power saving, hibernation, standby, and screen saver must be deactivated.
 - In case you use an USB-to-COM box, the option "Allow the computer to turn off this device to save power" in the devicemanager must be deactivated for all USB hosts.
 - Applies to all LAN devices: Disable the setting for the network adapter in Device Manager "Allow the computer to turn off this device to save power".

- Procedure**
1. In Windows choose Start > Control Panel > Network and Sharing Center.
 2. Double-click on LAN connection.
 3. Click on the button Properties.
 4. Select Internet Protocol version 4 (TCP/IPv4).
 5. Click on the button Properties.
 6. Check the settings in the tab General. The correct settings for the DHCP client are: a) Obtain an IP address automatically) Obtain DNS server address automatically.
 7. Click on the button OK.

4.5.6 Connect devices to LAN

A router ③ has several LAN ports ② and one WAN port ④ that can be used to integrate the LAN into a wide area network (WAN), e.g. a company network or the Internet. In contrast, the LAN ports serve to set up a network from devices ① and a computer ⑤. To avoid interference, we recommend operating the chromatography system separately from the company network.

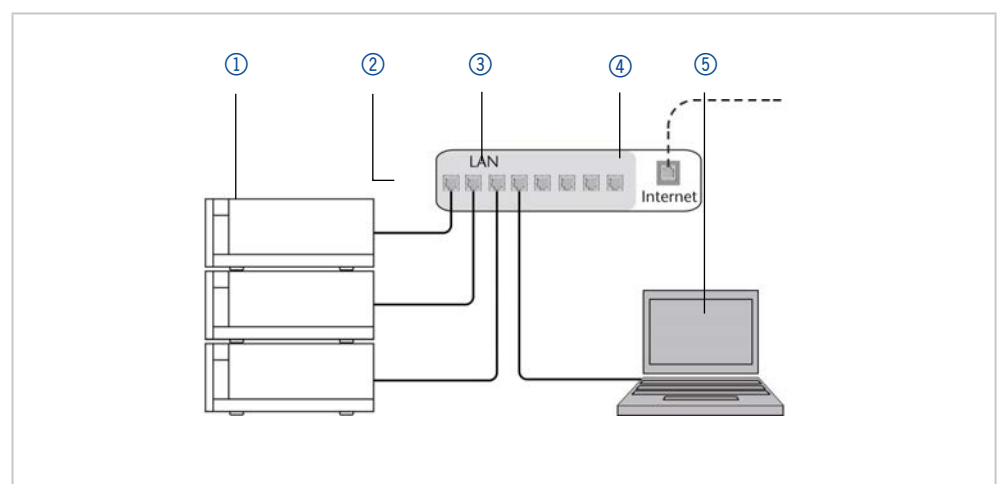

You will find patch cables for each device and the router in the accessories kit. To connect the router to a LAN, an additional patch cable is required, which is not supplied within the scope of delivery.

- Prerequisites**
- The computer has been switched off.
 - There is a patch cable for each device and the computer.

- Procedure**
1. Use the patch cable to connect the router and the computer. Repeat this step to connect all devices.
 2. Use the power supply to connect the router to the mains power system.

4.5.7 Configuring the router

The router is preset at the factory. Information about address, user name and password is noted in the router manual: www.knauer.net/router

- Procedure**
1. To open the router configuration, start your Internet browser and enter the IP address (not for all routers).
 2. Enter user name and password.
 3. Configure the router as DHCP server.
 4. In the router configuration, check the IP address range and make changes if necessary.



Note: If the IP address range should have been changed, make sure to note this information on the router.

Result Once the router has assigned IP addresses to all devices, the chromatography software can be used to remotely control the system.

4.5.8 Integrating the LAN into the company network

A network administrator can integrate the LAN into your company network. In this case you use the WAN port of the router.

Prerequisites There is a patch cable for the connection.

- Procedure**
1. Check that the IP address range of the router and of the company network do not overlap.
 2. In case of an overlap, change the IP address range of the router.
 3. Use the patch cable to connect the router WAN port to the company network.
 4. Restart all devices, including the computer.

4.5.9 Controlling several systems separately in the LAN

Devices connected to a LAN communicate through ports, which are part of the IP address. If more than one chromatography systems are connected to the same LAN and you plan on controlling them separately, you can use different ports to avoid interference. Therefore, the port number for each device must be changed and this same number must be entered into the device configuration of the chromatography software. We recommend to use the same port number for all devices in the same system.



Note: The port is set to 10001 at the factory. You must use the same numbers in the device configuration of the chromatography software as in the device, otherwise the connection fails.

- Procedure**
1. Find out port number and change it on the device.
 2. Enter the port number in the chromatography software.

Result The connection is established.

4.5.10 Analog control

Analog ports serve for exchanging analog control signals. Reference point for the signals is the connector GND.

OUT: Device sends signal.

IN: Device receives signal.

5. Operation

5.1 Switching on the pump



Note: Operator errors and clogged capillaries can cause high pressure spikes.

NOTICE

Component defect

Possible damage to the pump head due to dry running.

→ Make sure that solvent flows through the pump head and piston backflushing.



Process

1. Switch on the pump. The device performs a self-test.
2. Wait until the pump has completed the self-test.
3. After the test has been successfully completed, the program that was active last is displayed. The pump is now ready for operation.

5.2 Configuring the LPG module

In the *Setup* menu, up to three channels can be activated for the solvents used.

Process

1. Press  to go to the Main menu.
2. Press  to open the device settings.
3. Use the arrow keys to select the *Gradient* mode submenu.
4. Use the arrow keys up and down to choose LPG-2 for binary or LPG-3 for ternary gradient. Confirm with  or press any horizontal key.

5.3 Purging the pump

NOTICE

Column defect

Damage to the column due to purging.

- Open the venting screw.
- Remove the column.

Before the pump can be used, it must be purged to remove excess air in the capillaries.

Flush the pump in the following cases:

- When is purging required?**
- At initial startup to eliminate air bubbles in hoses and capillaries.
 - When changing solvents.
 - After using buffer solutions to eliminate salt residues.
 - Before turning off, if you do not plan to restart the device within shortly.

- Prerequisites**
- The installation has been completed.
 - The capillaries and tubings have been connected.
 - The pump has been switched on and is in „flow mode“.

- Tool**
- Syringe with Luer lock.

Use the purging solvent to be used in the following application.



Note: The purging process may take a while during initial operation because the solvent tubes are filled with liquid for the first time.



Note: If a buffer solution is used, pay attention to choosing a solvent for purging in which the buffer solution is soluble.

Procedure

Process

1. Open the venting screw ① of the pressure sensor.
2. Connect the syringe with the silicone tubing to the outlet ②.
3. Press the purging button  to open the purging mode and select respective gradient and flow.
4. With the syringe, extract fluid through the purge port ②.
5. If the extracted fluid flows continuously, stop suction and close the venting screw ①.

Figure

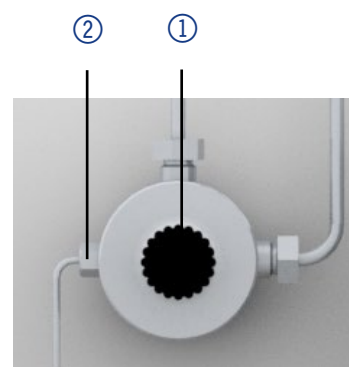

Fig. 16: Venting screw of the pressure sensor

The purging process of the pump is limited to a maximum pressure of 5 MPa. If this value is exceeded during the purging process, the pump switches off automatically. If you are using very small hoses and capillaries, the pressure can be too high.

5.3.1 Piston backflushing

The pump is equipped with automatic piston backflushing. It increases the service life of the seals and pistons, and removes contaminants from the area behind the seals.

Functional principle

The piston backflushing function automatically flushes the rear piston area of the pump head upon switch-on and in continuous mode.

- Upon switch-on: The rear piston area of the pump head is automatically flushed for 15 seconds.
- In continuous mode: The rear piston area of the pump head is flushed automatically every 30 minutes for 15 seconds.

Recommended purging solution

Select a suitable solvent in the backpiston flushing. The solvent used for the flushing depends on the application and the used solvent in the pump:

Solvent in the pump	Piston backflushing
Reverse phase solvents	50% isopropanol or ethanol with 50% water (v/v)
Normal phase solvents	100% isopropanol
Buffers with high salt concentrations	Rinse with water containing 5% ethanol or isopropanol

Legend

- ① Inlet from the solvent bottle to the flush pump
- ② Outlet from the flush pump to the pump head

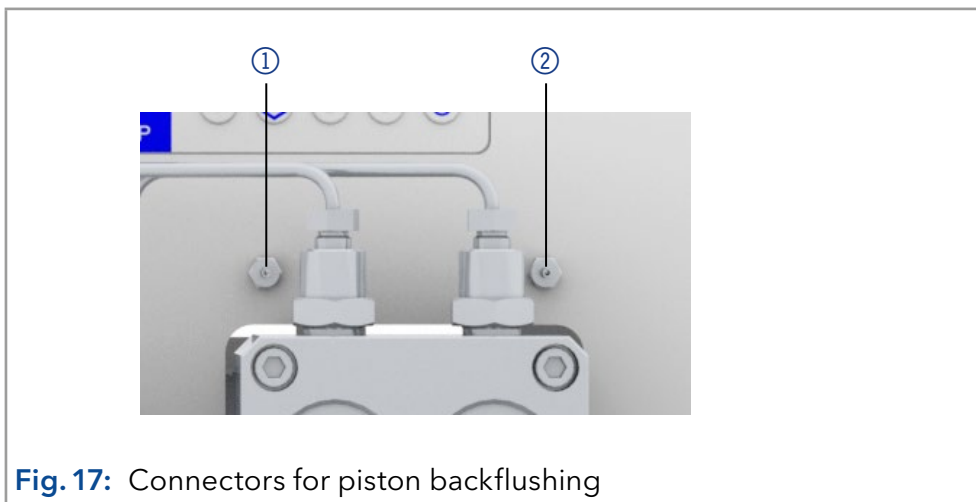

Fig. 17: Connectors for piston backflushing

5.4 Switch on and self test

Procedure

1. Switch on the pump.
2. The display shows *Initialization*. The device runs a self test.
3. Wait until the self test has been completed.
4. After the test has been successfully completed, the most recently active program will be displayed.

5.5 Operating with LC display and keypad

The LC display operation of the pump is suitable for the following tasks:

- Monitoring device functions.
- Using special programs for laboratory work:
 - Flushing program
 - Standby and Wake up (WU) program
 - Program sequences (*Link* menu)
 - Checking the system status as part of quality assurance measures in accordance with good laboratory practices (*GLP* menu).

Legend

- ① Status LED
- ② Status Play/Stop
- ③ Remote control
- ④ Gradient modus
- ⑤ Parameters and values
- ⑥ RFID recognition of the pump head
- ⑦ Keypad

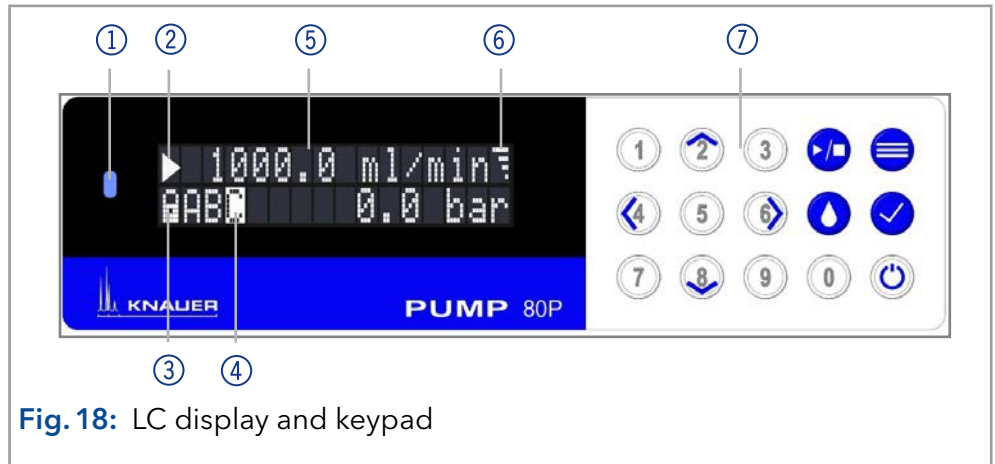





Fig. 18: LC display and keypad

5.5.1 LED status

The status of the device is indicated by an LED on the front side. The color of the LED shows the current status.

LED	Status	
	Green	Pump is ready (idle status).
	Green flashing	Pump is running.
	Yellow	Firmware upload in progress.
	Yellow flashing	Device initialization.
	Red	A serious error occurred.
	Red flashing	An acknowledgeable error occurred.
	Blue	Device in standby.







5.5.2 RFID icon

The status of a RFID valve is shown on the display in the main display.

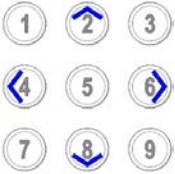
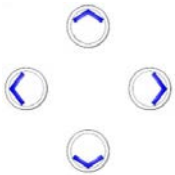
RFID	Status	
	Icon	RFID tag found.
	Icon flashing	RFID tag not found

5.5.3 Operating with the keypad







The keypad consists of 15 buttons, which allow to operate the device.

Key	Function	Explanation
	Numeric pad	<ul style="list-style-type: none"> Activation of numeric pad by pressing the <i>confirmation</i> button at input fields. Changing values.
	Navigation button	<ul style="list-style-type: none"> Navigation through menu with horizontal keys <>. Adjustment of values at input fields with vertical keys ^ v.
	Menu button	<ul style="list-style-type: none"> Select main menu. Return to one menu further up in the menu structure .
	Confirmation button	<ul style="list-style-type: none"> Confirm selection. Entering sub menu. Activation of numeric pad usage at input value.
	Start and stop button	Starts or stops the pump with set values.
	Purge button	Opens purge option.
	Standby button	<ul style="list-style-type: none"> Starts standby mode. Inserts a decimal point if numeric pad is activated.



5.6 Menu structure

5.6.1 Main menu

The main menu contains the current parameters of the pump.





Process	Figure
1. To navigate between the different main menus, use the horizontal arrow keys   .	 ①
2. In the four main screens the status of the pump is shown. Flow pressure, gradient modulus ①, events ②, and gradient composition ③ can be adjusted. In the fourth screen programs and links can be started ④.	 ②
	 ③
3. Press  to access the submenus <i>Setup</i> , <i>GLP</i> , <i>Program</i> and <i>Link</i> .	 ④



Note: If the status PLAY ► is displayed on the screen, the pump is not running. By pushing  the pump starts running. If STOP ■ is displayed, the pump is running. Press  to stop the pump.

Navigate through main menu

Procedure

1. Press  to access the menu.
2. Navigate between menu points by using horizontal arrow keys  .
3. Enter submenus using .



Note: With the vertical keys, you can increase and decrease the displayed values. If you want to use the numeric pad, simply press the confirm button to activate numeric pad. A decimal point is located on the standby key in case the numeric pad is activated.

5.6.2 Menu structure: overview



Fig. 19: Menu structure overview

5.6.3 Device setting parameters

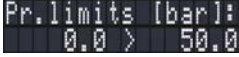
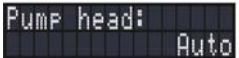
Menu	Explanation	Figure
<p>Cntl. Interface</p>	<p>Setting for external communication connection of the pump. The connections are on the rear side of the device.</p> <ul style="list-style-type: none"> ■ Serial: RS232-11520, RS232-38400, RS232-19200, RS232-9600 serial interface ■ LAN-DHCP: Automatic network configuration ■ LAN manual: Manual network-configuration (Port, IP address, IP mask, Gateway) ■ Analog: Manual control of the pump <p>Note: After changing the settings for external communication, the device should be restarted.</p>	
<p>Pr. limits</p>	<p>Settings for the minimum and maximum pressure. The pump stops automatically if the pressure drops below the minimum value or exceeds the maximum value. The minimum pressure value is used to ensure that the pump does not run dry. If the minimum is set to 0, the minimum system pressure is not monitored.</p>	
<p>Pump head</p>	<p>Pump head selection:</p> <ul style="list-style-type: none"> ■ automatic detection ■ 100 ml ■ 250 ml ■ 500 ml ■ 1000 ml <p>Note: The manual selection of the pump head size is only possible if the automatic recognition of the pump could not be performed. The selection is used as a basis for calculating the flow rate and determines the maximum system pressure. This value applies for all operating modes and cannot be exceeded.</p>	

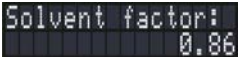
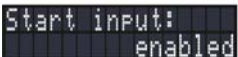
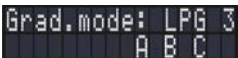
Solvent factor	<p>Data entry for the compressibility of the selected solvent:</p> <ul style="list-style-type: none"> ■ Water: 0.46 ■ Benzene: 0.95 ■ Chloroform: 0.97 ■ Ethanol: 1.10 ■ Acetone: 1.23 ■ Methanol: 1.21 ■ n-heptane: 1.40 ■ n-hexane: 1.50 ■ Diethyl ether: 1.84 ■ Acetonitril: 0.99 ■ Tetrahydrofuran: 0.93 ■ Water/methanol (10/90): 1.17 ■ Water/methanol (20/80): 0.86 ■ Water/methanol (40/60): 0.56 ■ Water/methanol (50/50): 0.52 ■ Water/methanol (60/40): 0.46 ■ Water/methanol (80/20): 0.40 ■ Water/methanol (90/10): 0.34 	
Start input	<p>After receiving a signal from an external device, the device or a program start an automatic run. Software sends a trigger signal via LAN.</p> <p>There are four possible settings:</p> <ul style="list-style-type: none"> ■ Enabled: Program starts. ■ Disabled: No program starts. ■ Start pump: Pump starts to run. ■ Stop pump: Running pump stops. 	
Grad mode	<p>Setting of type and channel for high pressure gradient (HPG), low-pressure gradient (LPG) and isocratic system:</p> <ul style="list-style-type: none"> ■ Select type: <ul style="list-style-type: none"> – HPG-A to HPG-D – LPG-2 (binary) – LPG-3 (ternary) – None (isocratic) ■ Channel A-D: ON/OFF Activate up to four channels <p>Note: The gradient modus is displayed as A, B, C or D with filled background in the lower left area of the main window.</p>	

Analog output setup

Output of analog pump signals to external devices by means of the remote terminal strip:

- Offset data entry for the analog output.
- Full Scale Voltage range options: 1 V, 2 V, 5 V
- Signal source
 - Pressure preset for the output of the currently measured pressure for the purpose of external recordings or control.
 - Slave B for the output of a signal for controlling a second pump.
 - Disabled
- Time constant OUT: Set the time constant for analog output to be used for signal smoothing. The larger the value of the selected time constant, the stronger the applied signal smoothing.

A small rectangular LCD display with a black background and white text. The text is arranged in two lines: 'ANALOG OUTPUT' on the top line and 'SETUP >' on the bottom line. The right side of the display is partially obscured by a vertical dotted line.

Analog input setup

Note: Before operating this configuration, change to the Network configuration and set the external communication port of the pump to Analog (see Cntl. Interface).

Configure the analog input of the remote connector for an external flow rate control:

- Actual interpreted flow: 0.000 ml/min
- Procedure: Set to Zero
- Define an applied input voltage as zero point with the flow rate of 0.000 ml/min. If a deviating positive control voltage is applied, a resulting flow rate is displayed at actual interpreted flow, based on the basic setting:
 - 10 ml corresponds to 1 V for the 100 ml pump head
 - 50 ml corresponds to 1 V for the 500 ml pump head
 - This flow rate value can be changed. Thus, a second calibration point is generated, which modifies the scaling.
- Time constant: Set the time constant for analog input to be used for signal smoothing (0.1-10.0 S). The larger the value of the selected time constant, the stronger the applied signal smoothing.

Event check



Testing the events of the pin header connectors.

- Start-IN and Error-IN: Status at the digital inputs.
- Active only: Connects Event 1 to Event 8 and 24 V.

5.7 GLP menu

In the *GLP* menu, statistical data on important parameters of the pump are displayed.

Navigate through GLP menu





- Procedure**
1. Use the horizontal keys   to navigate through the submenu.
 2. If no buttons are pressed, the display returns to the main menu after a short time.
 3. The menu contains no editable parameters.

5.8 Program menu

The menu *Program* is used to list and create programs. The pump can save up to 19 programs and up to 100 program lines with the following functions:

- Controlling the flow rate.
- Controlling the solvent composition.
- Sending control signals (Events).









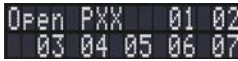

Navigate through Program menu

- Procedure**
1. Open a program number of your choosing.
 2. Use the horizontal arrow keys   to navigate through the two lines of the display.
 3. To change a value, press  and change the value by the numeric pad.
 4. Move the cursor to the double arrow  on the lower left line to navigate to the next line or create a new line.



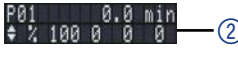
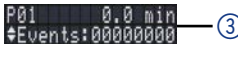



5.8.1 Create program

The use of the display is demonstrated using the example of a program to be created:

Program 01 is used to create a solvent gradient (channels A and B) with constant flow of 100 ml/min. The percentage of solvent A is to be continuously decreased from 100 % to 0 % within 0.50 minutes.

Process	Figure
1. Select the <i>Device program</i> menu.	
2. Select the desired program number.	
3. The parameters for time 0.00 min can be changed by navigation with the horizontal keys   to the different parameters like time/flow  , gradient composition  and events  .	  
4. Navigate to the double arrow on the lower left side of the display and press the downward key  to create a new line.	
5. Enter the time value of the new line and adjust the respective parameters.	
6. Press  for two seconds to exit the submenu. The program is automatically saved.	

5.8.2 Run program

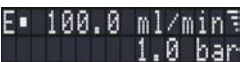

Process	Figure
<ol style="list-style-type: none"> 1. Navigate to the program main screen via the horizontal arrow keys  . 2. Move the cursor to the area behind the P, press  and type in the program number via the numeric pad. 3. Upon entering the program number, the pump will start pumping in status hold, indicated by the letter H at the upper left corner. 	
<ol style="list-style-type: none"> 4. Navigate the cursor with the horizontal keys to the status symbol and press the upward key  to change the status from hold (H) to run (R). The program starts running. 	
<ol style="list-style-type: none"> 5. After the program has been completed, the display switches into the status end (E). 6. Press  to stop the pump. 	

5.8.3 Change program



When new values for the different program lines are entered, the old values are overwritten.

- Procedure**
1. Select the menu *Program*.
 2. Select a program number.
 3. Navigate to the desired line and value.
 4. Activate the numeric pad by pressing  and enter a new value.

5.8.4 Delete program lines

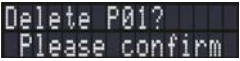

- Procedure**
1. Select the menu *Program*.
 2. Select the desired program number.
 3. Navigate to the to be deleted program line.
 4. Change the time value of the line to 0.000.
 5. Confirm with  or deny with .

5.8.5 Delete a program

Process	Figure
<ol style="list-style-type: none"> 1. Select the menu <i>Program</i>. 2. Select the program 00. 3. Activate the numeric pad by pressing  and enter the program number you wish to delete. 4. You will be asked whether you really want to delete the program. Confirm with  or deny with . 	

5.8.6 Create a program with a starting time



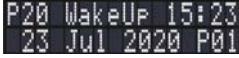

The pump can start a program at a preset time (*Wake Up* program). The pump starts the selected program at the specified time and date. The display switches from standby to run mode.

Process	Figure
<ol style="list-style-type: none"> 1. Select the menu <i>Program</i>. 2. Enter program number 20. 3. Enter the time, date and program number you wish to start by navigation with the horizontal keys   and activate the numeric pad by pressing . 4. To run the <i>Wake Up</i> program follow the procedure as if running any other program. Upon choosing program 20 the pump will go into standby until the set wake up time and date. 	

5.9 Link menu

The *Link* menu displays the status of active links. A maximum of ten program links between defined programs can be created and saved.

Navigate Link menu

- Procedure**
1. Open the desired link number.
 2. Use the horizontal arrow keys   to navigate through the two lines of the display.
 3. To change a value use the vertical arrow keys   or press  and change the value by the numeric pad.
 4. Move the cursor to the double arrow on the lower left line to navigate to the next line or create a new line.

5.9.1 Create link

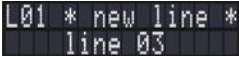



Process	Figure
<ol style="list-style-type: none"> 1. Select the <i>Link</i> menu. 2. Enter the link number. 3. Press  to enter the editing mode of the link. 4. Move the cursor to position P in the display and enter the program number you wish to run. 5. Move the cursor to position R (Repeat) and enter the number of repetitions for the specified program. 6. Move the cursor to position W in the display and enter 1 or 0. 	



Note: If W1 (W = Wait) is used, the pump waits for an external start signal or for the user to press the upward key to set the status to run before executing this line. If the W0 setting is used, the link sequence runs without interruption.



5.9.2 Run link

After the link has been completed, the display switches to the end mode, indicated by the letter E at the upper left corner.

- Procedure**
1. Go to the main menu.
 2. Navigate to *Link/Program* in the lower left display line and choose *Link* with the vertical arrow key  .
 3. Enter a link number.
 4. The pump status switches to the status hold (H) and starts pumping with the initial flow rate of the program.
 5. Navigate to the pump status and press the up arrow key  to set the pump into a run status (R).
 6. The link will start running the programs.
 7. Use the down arrow key  with the cursor on the pump status to pause the execution of the link (Status: H).
 8. Press the up arrow key to resume the run (Status: R).

5.9.3 Delete link

Process

1. Select the menu *Link* and choose the link 00.
2. Activate the numeric pad by pressing  and enter the desired program number you wish to delete.
3. Confirm with  or deny with .

Figure

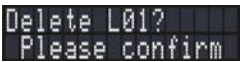

Delete L01?
Please confirm

6. Functionality tests



Note: Standard processes regarding IQ and OQ in single devices may be handled differently in individual cases.

6.1 Installation Qualification (IQ)

The customer may request the Installation Qualification, which is free of charge. In case of a request, the technical support of KNAUER or from a provider authorized by KNAUER performs this functionality test during the installation.

The Installation Qualification is a standardized document that includes the following:

- Confirmation of flawless condition at delivery.
- Check if the delivery is complete.
- Certification on the functionality of the device.

6.2 Operation Qualification (OQ)

The Operation Qualification includes an extensive functionality test according to KNAUER standard OQ documents. The Operation Qualification is a standardized document and free of charge. It is not part of the delivery. Please contact the technical support in case of request.

The Operation Qualification includes the following:

- Definition of customer requirements and acceptance terms.
- Documentation on device specifications.
- Device functionality check at installation site.

Test Intervals	To make sure that the device operates within the specified range, you should test the device regularly. The test intervals depend on the usage of the device.
Execution	The test can be carried out either by the technical support of KNAUER or from a provider authorized by KNAUER (for a fee).

7. Troubleshooting

First measures for troubleshooting:

- Check all screw fittings.
- Check whether air has gotten into the supply lines.
- Check device for leaks.

Further measures:

- Check errors against error list.
- Contact the technical support hotline of the manufacturer.

7.1 LAN

Go through the following steps, in case no connection between the computer and the devices can be established. Check after each step if the problem is solved. If the problem cannot be located, call the technical support.

1. Check the status of the LAN connection in the Windows task bar:



If no connection was established, test the following:



- Is the router switched on?
 - Is the patch cable connected correctly to the router and the computer?
2. Check the router settings:
 - Is the router set to DHCP server?
 - Is the IP address range sufficient for all the connected devices?
 3. Check all connections:
 - Are the patch cable connected to the LAN ports and not the WAN port?
 - Are all cable connections between devices and router correct?
 - Are the cables plugged in tightly?
 4. If the router is integrated into a company network, pull out the patch cable from the WAN port.
 - Can the devices communicate with the computer, even though the router is disconnected from the company network?
 5. Turn off all devices, router, and computer. First switch on the router and wait until it has successfully completed its self-test. Firstly, turn on the router and secondly turn on the devices and the computer.
 - Has this been successful?
 6. Replace the patch cable to the device with that no connection could be established.
 - Has this been successful?
 7. Make sure that the IP port of the device matches the port in the chromatography software.

7.2 Possible problems and solutions

Issue	Solution
Pump will not turn on	<p>The power cable must be connected to the power supply.</p> <ul style="list-style-type: none"> ■ Inspect the power cable to ensure that it is plugged into the power supply.
When purging, the pump switches off	<p>The venting screw on the pressure sensor must be turned up.</p> <ul style="list-style-type: none"> ■ Check if the venting screw on the pressure sensor is turned open.
Pump does not transport solvent	<p>Check the following options:</p> <ul style="list-style-type: none"> ■ Purge the pump head so as to remove the air bubbles. ■ Inspect the eluent filter of the HPLC column and change when blocked. ■ Replacing the pump head. ■ Cleaning the check valves. ■ Changing the check valves. ■ If the pump head seals are defective, solvent enters the piston backflushing; inform the technical support.
Pressure or flow rate fluctuations	<p>Check the following options:</p> <ul style="list-style-type: none"> ■ Cleaning the check valves. ■ Changing the check valves. ■ Purge the pump head so as to remove the air bubbles. ■ Tighten the capillary screw fittings on to the inlet and outlet screw fittings of the pump head (see chapter 8.6 on page 54).
Pump head leaks	<ul style="list-style-type: none"> ■ Check the following options: ■ Inspect and tighten the inlet and outlet screw fittings of the pump head. ■ Replacing the pump head. ■ If the pump head seals are defective, solvent enters the piston backflushing; inform the Technical Support.
Flow rate is not correct	<p>Check the following options:</p> <ul style="list-style-type: none"> ■ Check the data for the solvent compressibility. ■ Cleaning the check valves. ■ Changing the check valves.

7.3 System messages

Explanation of the displayed system messages. They are sorted alphabetically.

	System message	Solution
A	Auto pump head: Head data uninitialized!	<ul style="list-style-type: none"> Switch the device off and on. Check whether a pump head with RFID recognition has been installed. Repeat the automatic configuration step in the chromatography software. Remove pump head, clean it and install it again.
	Auto pump head: No head detected!	<ul style="list-style-type: none"> Switch the device off and on. Repeat the automatic configuration in the chromatography software. Remove pump head, clean it and install it again. Check whether a pump head with RFID recognition has been installed.
	Auto pump head: No RFID hardware!	Pump head without RFID detection: If necessary, replace pump head.
	Auto pump head: Read failed!	<ul style="list-style-type: none"> Switch the device off and on. Repeat the automatic configuration step in the chromatography software. Remove pump head, clean it and install it again.
		Note: Inform the technical support in case the system message repeats itself.
C	Auto pump head: write failed!	<ul style="list-style-type: none"> Switch the device off and on. Repeat the automatic configuration step in the chromatography software. Remove pump head, clean it and install it again.
		Note: Inform the technical support in case the system message repeats itself.
	Cannot delete active program/link	Pause active program or otherwise the link and the delete the link .
	Cannot edit program from the running link	First stop the link and then edit the data on the device display or with the chromatography software.
	Cannot initialize LAN	Check the cables and connections in the local area network.

System message	Solution
Cannot operate with an empty link	The link is empty. First create a link .
Cannot read data from FRAM	Switch the device off and on. Inform the technical support in case the system message repeats itself.
Cannot read RTC	Switch the device off and on. Inform the technical support in case the system message repeats itself.
Cannot start time table	Edit the data on the device display or in the chromatography software.
Cannot use non-existing component!	Change the setup settings or change the gradient in the program or in setup .
Cannot write data on FRAM	Switch the device off and on. Inform the Technical Support in case the system message repeats itself.
CRC failed	Switch the device off and on. Inform the technical support in case the system message repeats itself.
E	Error input activated
Device error, change device settings.	
G	GUI communication failed (internal)!
Switch the device off and on. Inform the technical support in case the system message repeats itself.	
I	Instrument in error state
Switch the device off and on. Inform the technical support in case the system message repeats itself.	
Instrument in standalone mode	<ul style="list-style-type: none"> ■ Change the entry in the Setup menu. ■ Change the entry in the chromatography software.
Instrument in standby mode	Press the standby button to end the standby mode.
Instrument remote controlled	<ul style="list-style-type: none"> ■ Change the entry in the Setup menu. ■ Change the entry in the chromatography software.
Insufficient access	Change the entry.
Invalid command	<ul style="list-style-type: none"> ■ Change the entry. ■ Check the cable connections.
Invalid parameter(s)	Check the validity of the parameter(s).
Invalid time in time table	Correct the time entry.

	System message	Solution
	Invalid time table index	Change the entry in the program line.
	I2C failed for panel	Switch the device off and on. Inform the technical support in case the system message repeats itself.
L	Link is loaded	First unload the link then change the link or delete it.
	Link is running	Wait until the link has been completed, then change the link or delete it.
M	Maximum pressure! System stopped	<ul style="list-style-type: none"> ■ Reduce the pressure or adjust the upper pressure limit. ■ Restart the system.
	Memory error	Switch the device off and on. Inform the technical support in case the system message repeats itself.
	Minimum pressure! System stopped	<ul style="list-style-type: none"> ■ Increase the pressure or adjust the lower pressure limit. ■ Restart the system.
	Motor failure	Switch the device off and on. Inform the technical support in case the system message repeats itself.
N	No link available	Create a link and edit it.
	No link available, pls edit link first	Create a link and edit it.
	No time table to start	Edit the data by means of the chromatography software.
	Non-existing component is set to non-0 value	Switch on the channel or edit the data using the chromatography software.
	Not enough space to store link	<ul style="list-style-type: none"> ■ Check the pump. ■ Check the number of program lines. A maximum of 100 program lines are possible.
	Not enough space to store program	<ul style="list-style-type: none"> ■ Check the pump. ■ Check the number of program lines. A maximum of 100 program lines are possible.
	Not supported	Change the entry.
P	Prg not compatible with pump head!	Modify the program or replace the pump head.
	Program does not exist	Create and edit a program.

	System message	Solution
	Program is running	Quit program or wait until program has been completed.
S	Sum of components is not 100	Change the entry.
T	The gradient component is used!	First unload the program. The setup data can only be edited when no program has been loaded or started.
	this link is used in WAKEUP	First quit or delete wakeup program (WakeUp) and then edit or delete the link.
	This program is used in a link	First pause or delete the link, then edit or delete data by means of the chromatography software.
	this program is used in WAKEUP	First quit or delete wakeup program (WakeUp) and then edit or delete the data by means of the chromatography software.
	Time already exists	Correct the time entry.
	Time table line is empty	Edit the program line.
	Too many lines in program	Check the number of program lines. A maximum of 100 program lines are possible.
U	Unknown pump head type!	<ul style="list-style-type: none"> ■ Check the pump head. ■ Check whether a pump head with RFID recognition has been installed.
W	Wake up time already passed!	Correct the entry for date or otherwise time.
	Wrong Line number	Change the line index in the link .
	Wrong link	<ul style="list-style-type: none"> ■ Check Link-Nr. Values from 1-10 are possible ■ Correct the entry.

8. Maintenance and care

Organic eluents are toxic above a certain concentration. Ensure that work areas are always well-ventilated! When performing maintenance tasks on the device, always wear safety glasses with side protection, protective gloves, and an overall.

All wetted components of a device, e. g. flow cells of detectors or pump heads and pressure sensors for pumps, have to be flushed with isopropanol first and water afterwards before being maintained, disassembled or disposed.

NOTICE

Electronic defect

Performing maintenance tasks on a switched on device can cause damage to the device.

- Switch off the device
- Pull the power plug.

Users may perform the following maintenance tasks themselves:

- Replacing the pump head
- Exchanging the Ball Valves

Proper maintenance of your HPLC device will ensure successful analyses and reproducible results.

8.1 Maintenance contract

The following maintenance work on the device may only be performed by the manufacturer or a company authorized by the manufacturer and is covered by a separate maintenance contract:

Opening the device or removing housing parts

8.2 Cleaning and caring for the device

NOTICE

Device defect

Intruding liquids can cause damage to the device.

- Place solvent bottles next to the device or in a solvent tray.
- Moisten the cleaning cloth only slightly.

All smooth surfaces of the device can be cleaned with a mild, commercially available cleaning solution, or with isopropanol.

Keypad The keypad of the modules can be cleaned with isopropanol and wiped dry with a soft, lint-free cloth.

8.3 Checking the fittings

Tools Torque wrench

8.3.1 Torque values

Pump head, stainless steel	Torque
100 ml	15 Nm
250 ml	15 Nm
500 ml	12 Nm
1000 ml	12 Nm

8.3.2 Tighten fittings

Process	Figure
<ol style="list-style-type: none"> 1. Always tighten the inlet screw 1 ③ and the outlet screw 1 ④ with a torque wrench. 2. Always hold the outlet fitting with a wrench when the capillary fitting ① is being tightened with a wrench. 3. Using an Allen wrench, screw in the opposite pairs of fastening screws ② evenly and alternately to prevent the pump pistons on the inside from jamming. 4. Tighten the knurled-head screw ⑤ on the eluent inlet. 	

Fig. 20: Screw fittings on the pump head

8.4 Flushing the pump

Generally, the pump and all its components (valves, degasser) should be flushed after each operation. Also, flush the pump to clean the tubing before changing the solvent and to remove air bubbles in the capillary and tubing. If buffer solution has been employed, note that the buffer solution and the flushing solution are compatible.

- When buffers have been used, flush with water.
- When aggressive solvents have been used, flush with isopropanol.

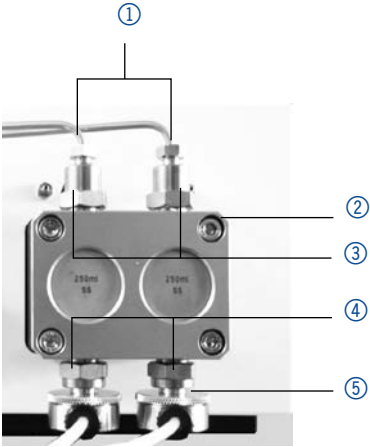

Note: For applications with normal phase, only use isopropanol as flushing solution.

- Materials**
- Flushing solution
 - Silicone tubing

Procedure**Process**

1. Immerse the solvent tubing into the flushing solution.
2. Plug a silicone tube onto the venting nozzle ② of the pressure sensor.
3. Open the venting screw ①.
4. Start the pump at a medium flow rate.

Figure

Fig. 21: Pressure sensor

Next step Bring the pump into operation again.

8.5 Pump head

Depending on the requirements of the user, different pump heads are used.

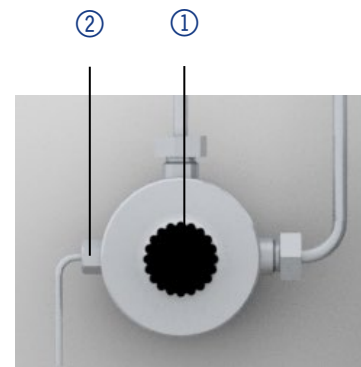
8.5.1 Dismounting the pump head

Prerequisites The pump head has been flushed.

Tools Allen screwdriver

DANGER

Life-threatening injuries

Health danger if getting in contact with toxic, infectious or radio-active substances.

- ➔ Before disposing of the device or sending it away for repair, you are required to decontaminate the device in a technically correct manner.



Note: Loosen the opposite pairs of fastening screws of the pump head evenly and alternately to prevent the pump pistons on the inside from jamming.

Procedure	Process	Figure
	<ol style="list-style-type: none"> 1. To remove the capillary, loosen the capillary screw fittings ① at the pump head outlet and pressure sensor inlet. 2. Disconnect the tubing of the piston backflushing from the inlet and outlet of the flush pump and from the pump head. 3. Remove the eluent lines ③ from the eluent inlets. 4. Using an Allen key, loosen the opposite pairs of fastening screws ② at the pump head evenly and alternately to prevent the pump pistons on the inside from jamming. 5. Hold the pump head by hand, and consecutively pull out all fastening screws. 6. Lift off the pump head. 	

Fig. 22: Removing the pump head

Next steps Maintain the check valves (see next section) or install a new pump head.

8.5.2 Installing the pump head

- Tools**
- Allen screwdriver
 - Tweezers may be necessary for removal

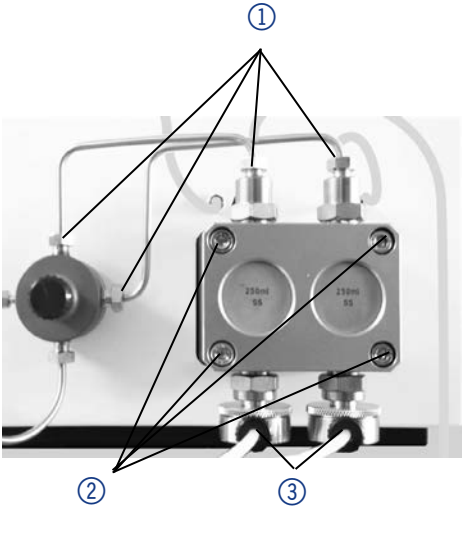
NOTICE

Device defect

Device defect due to intruding liquids.

- ➔ Use new capillary connections only, if leaks appear at the capillary fittings after maintenance or installation tasks.

Process

1. Using an Allen key, tighten the opposite pairs of fastening screws evenly and alternately to prevent the pump pistons on the inside from jamming.
2. Tighten all fastening screws evenly.
3. Screw tight the capillary screw fittings on the pump head and pressure sensor.
4. Screw the eluent lines into the eluent inlets.
5. Fasten the tubing of the piston backflushing at the inlet and outlet of the flush pump and the pump head.

8.6 Check valves

Clogged check valves do not open and close properly. They cause pressure fluctuations and irregular flow. If it is impossible to clean the check valves, replace the whole unit. Pay attention to the torques while tightening.

Pump head, stainless steel	Torques for Inlet and Outlet Fittings
100 ml	15 Nm
250 ml	15 Nm
500 ml	12 Nm
1000 ml	12 Nm

8.6.1 Removing the check valves

- Prerequisites**
- The pump head has been flushed.
 - The capillaries have been removed.
 - The pump head has been dismantled.

Tools Open-end wrench (torque), sizes 10 & 17

Procedure

Process

1. Unscrew the outlet fittings ①.
2. Remove the check valve ②.
3. Unscrew the inlet fittings ③.
4. Remove the check valve.

Figure

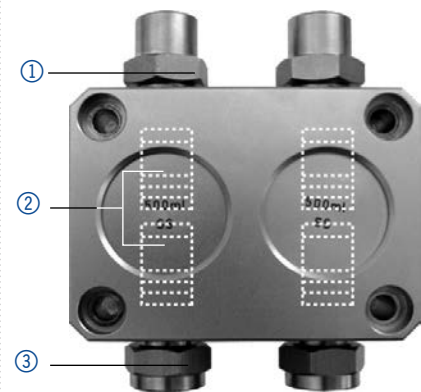

Fig. 23: Removing the check valve

Next Steps You can either replace or clean the check valves.

8.6.2 Cleaning the check valve

The check valves are not disassembled for cleaning but they are cleaned as a unit.

Procedure	Process
	<ol style="list-style-type: none"> 1. Place each check valve into a beaker with solvent, e.g. isopropanol. 2. Put the beaker with the check valve in an ultrasonic bath for at least 10 minutes. 3. Dry from the inside with compressed air, if possible.

Next step Insert both cleaned check valves.

8.6.3 Installing the check valve

When tightening inlet and outlet fittings, pay attention to the torques described in chapter Installation.

Prerequisites	<ul style="list-style-type: none"> ■ The pump head has been flushed. ■ The capillaries have been removed. ■ The pump head has been dismounted.
Tools	Open-end wrench (torque), sizes 10 & 17

NOTICE

Component defect

Damage to components due to excessive tightening possible.

- Observe the torque of the screw connection
- Use 5 Nm torque for stainless steel fittings.
 - Use 1 Nm torque for PEEK fittings.



Note: PEEK fittings can withstand pressures up to 400 bar for 1/16" and 200 bar for 1/8".



Note: The ball and position of the valves have been harmonized to each other. Insert the valves in the direction of flow.

Procedure	Process	Figure
	<ol style="list-style-type: none"> 1. Insert the check valves ① so that the notch of the check valve ② points downward. 2. Manually screw in inlet and outlet fittings and tighten them with a torque wrench and the respective torque. 	

Fig. 24: Check valve

Next step Re-install the pump head.

9. Transport and storage

Regarding the following information, carefully prepare the device for transport or storage.

9.1 Putting the pump out of operation

Prerequisites The device is switched off.

Procedure

Process

1. Pull the power plug out of the socket and then out of the device.
2. Pack the power cable together with the device.

Next steps Disconnect all electrical connections. Remove the accessories and pack the device for transport or storage.

9.2 Packing the device

- Original packaging: Ideally you should use the original transport packaging.
- Lifting: Grab the device around the center of both sides and lift it into the packaging. Do not hold onto front cover or leak tray, as these parts are loosely attached to the device.

9.3 Transporting the device

Carefully prepare the device for transport or storage. If you want to return your device to KNAUER for repairs, enclose the [Service Request Form](#) which can be downloaded from our website.

Device data For a secure transport, note the weight and dimensions of the device (see chapter 11 on page 59).

CAUTION

Bruising danger

Damage to the device by carrying or lifting it on protruding housing parts. The device may fall and thus cause injuries.

→ Lift the device only centrally on the side of the housing.

Lifting Clasp the device at its side panels and lift it out of the packaging. Do not hold onto front cover or leak tray.

9.4 Storing

9.4.1 Storing the device

If the pump is not used for several weeks solvent residues cause damage. Therefore make sure that all tubes and capillaries and pump heads (if they are to remain on the pump during storage) have been drained or filled with flushing solution (e.g. isopropanol) before storage. To avoid

algae formation, do not use pure water. Close all inlets and outlets with blind screwings.

- Prerequisites**
- The pump has been flushed.
 - The pump has been switched off and disconnected from the power supply.

- Tool**
- Open-end wrench, size 10

Procedure

Process

1. Remove the solvent tubing and seal all open connectors with cap fittings.
2. Remove the pump from the HPLC system and seal the open connector of the pressure sensor (isocratic version) or the mixer (binary, ternary or quaternary version) with cap fittings.

- Storage conditions** The device can be stored under the ambient conditions described in chapter (see chapter 11 on page 59).

9.4.2 Storing the pump head

NOTICE

Device defect

Residuals chemicals can damage the pump head if they are not being removed before storage.

- ➔ For reuse, flush the pump head and fill it with isopropanol.
- ➔ Before storage, seal the inlets and outlets with cap fittings.

If you want to store pump heads separately, proceed as follows:

- Prerequisite** The pump head has been dismantled (see chapter 8.5.1 on page 52).

- Materials**
- Syringe
 - Flushing solution

Procedure

Process

1. Fill the flushing solution into a syringe and inject into the capillary at the pump head inlet. Leave it for 5 minutes.
2. Flush with suitable purging solution.
3. Fill the pump head with isopropanol.
4. Seal the inlets and outlets with cap fittings.

- Storage conditions** The pump head can be stored under the ambient conditions described in chapter „Technical data“ on page 59.

10. Disposal

Hand in old devices or disassembled old components at a certified waste facility, where they will be disposed of properly.

10.1 AVV-Marking Germany

According to the German "Abfallverzeichnisverordnung" (AVV) (January, 2001), old devices manufactured by KNAUER are marked as waste electrical and electronic equipment: 160214.

10.2 WEEE registration number

KNAUER as a company is registered by the WEEE number DE 34642789 in the German "Elektroaltgeräteregister" (EAR). The number classifies to category 8 and 9, which, among others, comprises laboratory equipment.

All distributors and importers are responsible for the disposal of old devices, as defined by the WEEE directive . End-users can send their old devices manufactured by KNAUER back to the distributor, the importer, or the company free of charge, but would be charged for the disposal.

10.3 Eluents and other operating materials

All eluents and other operating materials must be collected separately and disposed of properly.

All wetter components of a device, e. g. flow cells of detectors or pump heads and pressure sensors for pumps, have to be flushed with isopropanol first and water afterwards before being maintained, disassembled or disposed.

11. Technical data

11.1 Solvent delivery

Pump type	Dual-piston pump with two operating pistons
Flow rate range	<ul style="list-style-type: none"> ■ 100 ml pump head: <ul style="list-style-type: none"> – 0.01-100 ml/min – 1-80 ml/min (recommended) – 1-40 ml/min (continuous working) ■ 250 ml pump head: <ul style="list-style-type: none"> – 0.01-250 ml/min – 2.5-200 ml/min (recommended) – 2.5-100 ml/min (continuous working) ■ 500 ml pump head: <ul style="list-style-type: none"> – 0.01-500 ml/min – 5-400 ml/min (recommended) – 5-200 ml/min (continuous working) ■ 1000 ml pump head: <ul style="list-style-type: none"> – 1-1000 ml/min – 10-800 ml/min (recommended) – 10-400 ml/min (continuous working)
Maximum pressure	<ul style="list-style-type: none"> ■ 100 ml pump head: <ul style="list-style-type: none"> – 400 bar to 100 ml/min ■ 250 ml pump head: <ul style="list-style-type: none"> – 225 bar to 100 ml/min – Linear reduction: 225-200 bar of 100-150 ml/min – 200 bar of 150-250 ml/min ■ 500 ml pump head: <ul style="list-style-type: none"> – 100 bar to 500 ml/min ■ 1000 ml pump head: <ul style="list-style-type: none"> – 75 bar to 350 ml/min – Linear reduction: 75-50 bar of 350-600 ml/min – 50 bar of 600-1000 ml/min
Flow rate accuracy	+/- 2 % at 5 - 50 % of the flow range with ethanol/water 10/90
Flow rate precision	< 0,1 % RSD, measured at 5 - 50 % of the flow range with ethanol/water 10/90

Gradient support	<ul style="list-style-type: none"> ■ Isocratic HPLC pump ■ Pump with binary or ternary LPG valve block (low pressure gradient system, LPG) ■ Up to 4 pumps in combination (high pressure gradient system, HPG)
System protection	Pmin and Pmax adjustable

11.2 Communication

Control	<ul style="list-style-type: none"> ■ LAN ■ RS-232 ■ Remote control connections (Stop, Flow, Pressure, Error) ■ Keypad
Pump head detection	Automatic detection via RFID
Programming	19 programs, 10 program links (Links), 1 <i>WAKE UP</i> program (Program 20)

11.3 General

Power supply	<ul style="list-style-type: none"> ■ Pump: 100-240 V, 50-60 Hz ■ Binary LPG valve block: 24 V ■ Ternary LPG valve block: 12 V
Supply frequency	50-60 Hz
Power consumption	<ul style="list-style-type: none"> ■ Pump: maximum 320 W ■ Binary or ternary valve block: 5 W
Protection type	IP 20
Dimensions (W × H × D)	407 x 242 x 191 mm (Depth x Width x Height)
Weight	13.2 kg
Area of use	For indoor use only
Line voltage fluctuations do not exceed ± 10 % of normal voltage.	
Overtoltage category II:	Energy consumers are supplied by a fixed device.
Permitted pollution degree	2
Temperature range	4 - 40 °C; 39.2 - 104 °F

Air humidity	below 90 %, non-condensing
Operating height	max. 2000 meters above sea level

12. Chemical compatibility of wetted materials



Note: The user takes the responsibility for using the fluids and chemicals in an appropriate and safe way. If there is any doubt, contact the Technical Support of the manufacturer.

12.1 General

The device is very resistant against a variety of commonly used eluents. However, make sure that no eluents or water come in contact with the device or enter into the device. Some organic solvents (such as chlorinated hydrocarbons, ether) may cause coating damage or loosen glued components by improper handling. Even small quantities of other substances, such as additives, modifiers, or salts can influence the durability of the materials. Exposure time and concentration have a high impact on the resistance.

The following list contains information about the chemical compatibility of all wetted materials which are used in devices made by KNAUER. The data bases on a literature research on the manufacturer specifications of the materials. The wetted materials of this device are listed in the chapter "Technical data".

All resistances mentioned here are for use at temperatures up to 40 °C, unless stated otherwise. Please note that higher temperatures can significantly affect the stability of different materials.

12.2 Plastics

Polyetheretherketone (PEEK)

PEEK is a durable and resistant plastic and, next to stainless steel, the standard material in HPLC. It can be used at temperatures up to 100 °C and is highly chemical resistant against almost all commonly used solvents in a pH range of 1-12,5. PEEK is potentially moderate resistant against oxidizing and reducing solvents.

Therefore, following solvents should not be used: Concentrated and oxidizing acids (such as nitric acid solution, sulfuric acid), halogenated acids (such as hydrofluoric acid, hydrobromic acid) and gaseous halogens. Hydrochloric acid is approved for most applications.

In addition, following solvents can have a swelling effect and may have an impact on the functionality of the built-in components: Methylene chloride, THF and DMSO in any concentration such as acetonitrile in higher concentrations.

Polyethylene terephthalate (PET, outdated PETP)

PET is a thermoplastic and semi-crystalline material with high wear resistance. It is resistant against diluted acids, aliphatic and aromatic hydrocarbons, oils, fats and alcohols, but not against halogenated hydrocarbons and ketones. Since PET belongs chemically to esters, it is not compatible with inorganic acids, hot water and alkalis. Maximum operating Temperature: up to 120 °C.

Polyimide (Vespel®)

This material is wear-resistant and permanent resilient thermally (up to 200 °C) as well as mechanically. It is chemically broadly inert (pH range 1-10) and is especially resistant against acidic to neutral and organic solvents, but vulnerable to pH strong chemical or oxidizing environments: It is incompatible with concentrated mineral acids (such as sulfuric acid), glacial acetic acid, DMSO and THF. In addition, it will be disintegrated by nucleophilic substances like ammonia (such as ammonium salts under alkaline conditions) or acetate.

Ethylene-tetrafluorethylene copolymer (ETFC, Tefzel®)

This fluorinated polymer is highly resistant against neutral and alkaline solvents. Some chlorinated chemicals in connection with this material should be handled with care. Maximum operating Temperature is 80 °C.

Perfluorethylenpropylen-Copolymer (FEP), Perfluoralkoxy-Polymer (PFA)

These fluorinated polymers hold similar features as PTFE, but with a lower operation temperature (up to 205 °C). PFA is suitable for ultrapure applications, FEP can be used universally. They are resistant against almost all organic and inorganic chemicals, except elemental fluorine under pressure or at high temperatures and fluorine-halogen compounds.

Polyoxymethylene (POM, POM-HTF)

POM is a semi-crystalline, high-molecular thermoplastic material which stands out due to its high stiffness, low friction value and thermic stability. It can even substitute metal in many cases. POM-HTF is a combination of PTFE fibres and acetal resin and is softer and has better slip properties as POM. The material is resistant against diluted acids (pH > 4) as well as diluted lyes, aliphatic, aromatic and halogenated hydrocarbons, oils and alcohols. It is not compatible with concentrated acids, hydrofluoric acid and oxidizing agent. Maximum operating Temperature is 100 °C.

Polyphenylene sulfide (PPS)

PPS is a soft polymer which is known for its high break resistance and very high chemical compatibility. It can be used with most organic, pH neutral to pH high, and aqueous solvents at room temperature without concerns. However, it is not recommended for using with chlorinated, oxidizing and reducing solvents, inorganic acids or at higher temperatures. Maximum operating temperature: 50 °C

Polytetrafluorethylene (PTFE, Teflon®)

PTFE is very soft and anti-adhesive. This material is resistant against almost all acids, lyes and solvents, except against fluid sodium and fluoride compounds. In addition, it is temperature-resistant from -200 °C to +260 °C.

Systec AF™

This amorphous perfluorinated copolymer is inert against all commonly used solvents. However, it is soluble in perfluorinated solvents like Fluorinert® FC-75 and FC-40, and Fomblin perfluor-polyether solvents from Ausimont. In addition, it is affected by Freon® solvents.

Polychlorotrifluoroethylene (PCTFE, Kel-F®)

The semi-crystalline thermoplastic material is plasticizer-free and dimensionally stable, even in a wide temperature range (-240 °C to +205 °C). It is moderately resistant against ether, halogenated solvents and toluene. Halogenated solvents over +60 °C and chlorine gas should not be used.

Fluorinated rubber (FKM)

The elastomer consisting of fluorinated hydrocarbon stands out due to a high resistance against mineral oils, synthetic hydraulic fluids, fuels, aromatics, and many organic solvents and chemicals. However, it is not compatible with strong alkaline solvents (pH value >13) like ammonia, and acidic solvents (pH value <1), pyrrole and THF. Operating temperature: Between -40 °C and +200 °C.

Perfluorinated rubber (FFKM)

This perfluoro elastomer has a higher fluorine content as fluorinated rubber and is therefore chemically more resistant. It can be employed at higher temperatures (up to 275 °C). It is not compatible with Pyrrole.

12.3 Non-metals

Diamond-like carbon (DLC)

This material is characterized by a high hardness, a low coefficient of friction and thus low wear. In addition, it is highly biocompatible. DLC is inert against all acids, alkalis and solvents commonly used in HPLC.

Ceramic

Ceramic is resistant against corrosion and wear and is fully biocompatible. An incompatibility against acids, alkalis and solvents commonly used in HPLC is not known.

Alumina (Al₂O₃)

Due to their high resistance to wear and corrosion, alumina ceramic is used as a coating for mechanically stressed surfaces. It is a biocompatible material with low thermal conductivity and low thermal expansion.

Zirconium oxide (ZrO₂)

Zirconia ceramics are characterized by their high mechanical resistance, which makes them particularly resistant to wear and corrosion. It is also biocompatible, has low thermal conductivity and is resistant to high pressures.

Sapphire

Synthetic sapphire is virtually pure monocrystalline alumina. It is biocompatible and very resistant to corrosion and wear. The material is characterized by a high hardness and a high thermal conductivity.

Ruby

Synthetic ruby is monocrystalline alumina and gets its red color by the addition of some chromium oxide. It is biocompatible and very resistant to corrosion and wear. The material is characterized by a high hardness and a high thermal conductivity.

Mineral wool

This insulating material consists of glass or stone wool fibres and isolates in high oxidizing conditions and at high temperatures. Mineral wool is valid as commonly inert against organic solvents and acids.

Glass, glass fibre, quartz, quartz glass

These mineral materials are resistant against corrosion and wear and are mostly chemical inert. They are compatible with oils, fats and solvents and show a high resistance against acids and lyes up to pH values of 3-9. Concentrated acids (especially hydrofluoric acid) may embrittle and corrode the minerals. Lyes may ablate the surfaces slowly.

12.4 Metals

Stainless steel

Stainless steel is, apart from PEEK, the standard material in HPLC. Mainly steels with WNr. 1.4404 (316L) are used, or with a mixture of higher compatibility.

They are inert against almost all solvents. Exceptions are biological applications which are metal ion sensitive, and applications with extreme corrosive conditions. These steels, in comparison to commonly used steels, are increasingly resistant against hydrochloric acid, cyanides and other halogen acids, chlorides and chlorinated solvents.

The use in ion chromatography is not recommended. In case of electrochemical applications, a passivation must be executed first.

Hastelloy®-C

This nickel-chrome-molybdenum alloy is extremely resistant to corrosion, especially against oxidizing, reducing and mixed solvents, even at high temperatures. This alloy may be used in combination with chlor, formic acid, acetic acid and saline solutions.

Titanium, titanium alloy (TiA16V4)

Titanium has a low weight and a high hardness and stability. It stands out due to its very high chemical compatibility and biocompatibility. Titan is applied when neither stainless steel nor PEEK are usable.

13. Repeat orders

13.1 Devices

Article	Order Number
Pump with 100 ml pump head, stainless steel, with accessories	APD30KA
Pump with 100 ml pump head, titanium, with accessories	APD60KB
Pump with 250 ml pump head, stainless steel, with accessories	APD30LA
Pump with 250 ml pump head, titanium, with accessories	ADP60LC
Pump with 500 ml pump head, stainless steel, with accessories	APD30MA
Pump with 500 ml pump head, titanium, with accessories	APD60MC
Pump with 1000 ml pump head, stainless steel, with accessories	APD30NA
Pump with 1000 ml pump head, titanium, with accessories	APD60NB

13.2 Spare parts

Article	Order Number
100 ml pump head, stainless steel, accessories	A4029-1
100 ml pump head, titanium, accessories	A4029V2
250 ml pump head, stainless steel, accessories	A4021-1
250 ml pump head, titanium, accessories	A4021V2
500 ml pump head, stainless steel, accessories	A4038-1
500 ml pump head, titanium, accessories	A4038V2
1000 ml pump head, stainless steel, accessories	A4022-1
1000 ml pump head, titanium, accessories	A4022V2
Check valve for 100 ml and 250 ml pump head	A1122
Check valve for 500 ml and 1000 ml pump head	A1080

Article	Order Number
network cable	A5255
Set of connector strips: 2 x connector strip, 12-pos., stylus	A1420V12
2 x flat ribbon cable (1.5 m, 10-pos.)	A1467
RS-232 connection cable	A0895
Instruction kit 80P	F4020V1.0
Accessory kit for 100 ml, 250 ml and 500 ml pump head	F4021
Accessory kit for 1000 ml pump head	F4022

Science Together



Latest KNAUER instructions online:
www.knauer.net/library

KNAUER
Wissenschaftliche Geräte GmbH
Hegauer Weg 38
14163 Berlin

Phone: +49 30 809727-0
Fax: +49 30 8015010
E-Mail: info@knauer.net
Internet: www.knauer.net