



Antec
Industrieweg 12
2382 NV Zoeterwoude
The Netherlands

DECADE Elite

User Manual

175.0010, Edition 1, 2015



Copyright ©2015, Antec, The Netherlands. Contents of this publication may not be reproduced in any form or by any means (including electronic storage and retrieval or translation into a foreign language) without prior agreement and written consent from the copyright of the owner. Antec reserves the right to make changes to the design and specifications of the instrument and this manual without prior notice.

ROXY, ALEXYS, DECADE, DECADE II, DECADE Elite, DECADE Lite, INTRO, Flexcell, ReactorCell, ISAAC, HyREF, Sen-Cell and SynthesisCell are trademarks of Antec. Whatman™ (word and device) and Whatman™ (word only) are trademarks of Whatman International Ltd. SOLVENT IFD™ and AQUEOUS IFD™ are trademarks of Arbor Technologies, Inc. Clarity®, DataApex® are trademarks of DataApex Ltd. Microsoft® and Windows™ are trademarks of Microsoft Corporation. Excel is a registered trademark of the Microsoft Corporation. All other trademarks are the property of their respective owners.

The software and the information provided herein is believed to be reliable. Antec shall not be liable for errors contained herein or for incidental or consequential damages in connection with the furnishing, performance, or use of software or this manual. All use of the software shall be entirely at the user's own risk.

Table of contents

Table of contents 4

- Warning Symbols 7
- Safety instructions 9

Introduction 13

- Instrument description 14

Installation 17

- Site Preparation Requirements 17
- Unpacking 18
- Mains connection 20
- PC connection 21
- Software 24
- HPLC fluid connections 29

Maintenance & Shutdown 37

- Maintenance 37
- Shutting down the system 39

DECADE Elite controller 41

- Introduction 41
- Overview of DECADE Elite screens 42
- Parameters 47
- Clarity DECADE Elite control module 55

Detection and Parameters 57

- Introduction 57
- Three-electrode configuration 57
- Internal organization 59
- Dual flow cell control 59
- Filter 64
- Introduction 77
- Hydrodynamic and scanning voltammogram 85

Specifications DECADE Elite 95

Rear panel I/O 99

- USB B connector 100
- LAN connector 100
- VALVE connector 100
- ANALOG DATA connector 104
- Digital I/O connector 106

Troubleshooting 111

- Instrument errors 111
- Analytical troubleshooting 113
- Dummy cell test 114
- Stop flow test 115

Detector accessories 121

Index 122

Intended use

The DECADE Elite Electrochemical Detector is used in combination with (Ultra) High Performance Liquid Chromatography for the electrochemical detection of suitable analytes in liquid samples. With this technique the amount of electroactive substances in mobile phase can be quantified. The instrument can be used for the chromatographic analysis of a wide range of electroactive analytes in the fields of for example:

- Bioanalytical analyses
- Food analyses
- Pharmaceutical analyses
- Environmental analyses



***For research purposes only.* While clinical applications may be shown, this instrument is not tested by the manufacturer to comply with the In Vitro Diagnostics Directive.**

Operation of an electrochemical detector can involve the use of hazardous materials including corrosive fluids and flammable liquids. The instrument should only be operated by users with the following expertise:

- Completed degree as chemical laboratory technician or comparable vocational training
- Fundamental knowledge of liquid chromatography
- Participation in an installation of the system performed by the manufacturer or a company authorized by the manufacturer and suitable training on the system and chromatography software.
- Knowledge and experience in the safe handling of toxic and corrosive chemicals and knowledge of the application of fire prevention measures prescribed for laboratories.

Information on safety practices is provided with your instrument and operation manuals. Before using your instrument or accessories, you must thoroughly read these safety practices. This manual is written for laboratory technicians who use the DECADE Elite detector for (U)HPLC analysis.



Unskilled, improper, or careless use of this instrument can create fire hazards, or other hazards which can cause death, serious injury to personnel, or severe damage to equipment and property. Observe all relevant safety practices at all times. Only use the device for applications that fall within the scope of the specified intended use. Else the protective and safety equipment of the device could fail.

WEEE directive

All equipment of Antec Leyden which are subjected to the WEEE directive shipped after August 13, 2005 are compliant with the WEEE marking requirements. Such products are labelled with the “crossed out wheelie”, depicted on the left site.



The symbol on the product indicates that the product **must not** be disposed as unsorted municipality waste.

Collection & recycling information

Please ship the instrument back to the manufacturer (Antec Leyden, the Netherlands) at the end-of-life time of the product. The manufacturer will take care of the proper disposal and recycling of the instrument at its facilities.

Shipping address for the end-of-life products:

Antec Leyden B.V.
Industrieweg 12
2382NV Zoeterwoude
The Netherlands

In case of questions, or if further information is required about the collection & recycling procedure, please contact your local distributor.



ROHS directive

The DECADE Elite is ROHS compliant and in conformity with Directive 2011/65/EU Restricted use of Hazardous Substances in electrical and electronic Equipment (ROHS).



Antec Leyden is an ISO 9001:2008 certified company.

Warning Symbols

The following symbols are used in this guide:



This sign warns about the risk of electric shock. It calls attention to a procedure or practice which, if not adhered to, could result in loss of life by electrocution. Do not proceed beyond a danger sign until the indicated conditions are fully understood and met.



The warning sign denotes a hazard. It calls attention to a procedure or practice which, if not adhered to, could result in severe injury, loss of life or damage or destruction of parts or all of the equipment. Do not proceed beyond a warning sign until the indicated conditions are fully understood and met.



The caution sign denotes a hazard. It calls attention to a procedure or practice which, if not adhered to, could result in damage or destruction of parts or all of the equipment and/or erratic results. Do not proceed beyond a cautions sign until the indicated conditions are fully understood and met.



The biohazard sign draws attention to the fact that use of biological materials, viral samples may carry a significant health risk.



The toxic hazard sign draws attention to the fact that use of toxic solvents or samples may carry a significant health risk.



The attention sign signals relevant information. Read this information.



The note sign signals additional information. It provides advice or a suggestion that may support you in using the equipment.

Safety instructions

Adhere to the following standard quality control procedures and the following equipment guidelines when using the DECADE Elite detector. The following safety practices are intended to ensure safe operation of the instrument.

Working environment & safety



The intended use of the instrument is to detect electroactive substances in liquid samples in combination with a (U) HPLC system in a GLP-approved environment. Operators using the system should have the appropriate education and an extensive understanding of GLP rules and be skilled in the art. Use this system **ONLY** for the intended use. Use of the system for any other purpose will cause unsafe situations.

System Operation



To assure optimal performance keep the detector we recommend that the instrument is checked regularly and maintenance procedures are carried out. Preventive maintenance contracts are available for that Purpose. Please contact your local dealer or the nearest sales office for more information.

Electrical safety



The removal of protective panels on the instrument can result in exposure to potentially dangerous voltages. Therefore, disconnect the instrument from all power sources before disassembly.

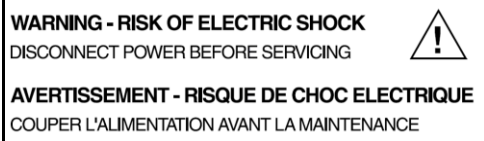

Untrained personnel should not open the instrument, **this may only be done by authorized service engineers**. Replace or repair faulty insulation on power cords immediately after discovery of the fault. Check that the actual power voltage is the same as the voltage for which the instruments are wired. Make sure power cords are connected to correct voltage sources: grounded AC power source, line voltage 100 – 240 VAC. The instrument should be connected to a protective earth via a ground socket. The DECADE Elite must only be used with appliances and power sources

with proper protective grounding to prevent damage through build-up of static electricity. The power source should exhibit minimal power transients and fluctuations. If necessary connect to a filtered mains socket.

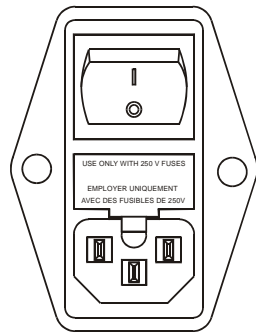

WARNING - RISK OF FIRE
REPLACE FUSE AS MARKED

AVERTISSEMENT - RISQUE DE FEU
REPLACEZ LE FUSIBLE COMME INDIQUÉ

V ~ 100-240V FUSE RATING

50/60Hz 

260VA 2.5 AT / 250V

Replace blown fuses with fuses of proper type and rating as indicated on the rear panel and as listed in the list of accessories and spares (appendix D). The fuse holder is integrated in the mains connector. Ensure that the instrument is never put in operation with fuses of a different type. This could cause fire. Only use manufacturer-supplied I/O cable(s) to connect with other devices. Thoroughly connect shielding to common. Manufacturer will not accept any liability for damage, direct or indirect, caused by connecting this instrument to devices and with cables which do not meet relevant safety standards.

Solvents



The solvents used may be flammable, toxic or corrosive. The room in which the system is installed should be well ventilated to prevent that solvent vapors cause poisoning or ignite and cause a fire. Use of open fire in the vicinity of this system must be strictly prohibited. Do not install the system in the same room with any other equipment that emits or could potentially emit sparks. Provide protective equipment near the instrument, when solvent gets into the eyes or on the skin, it must be flushed away immediately. Provide equipment, such eye wash stations and safety showers, as close to system as possible. Use proper eye and skin protection when working with solvents. Additional safety requirements or protection may be necessary depending on the chemicals used in combination with this equipment. Make sure that you understand the hazards associated with the chemicals used and take appropriate measures with regards to safety and protection.

Sample containers (vials) should be sealed to minimize any risks related to solvent vapor.



Biological Hazard

When you analyze biological fluids you need possible precautions and treat all specimens as potentially infectious. Always wear protective And gloves when handling toxic or biologically infectious samples to prevent bio hazards or hazards while working with the DECADE Elite. If necessary the instrument must be decontaminated before decommissioning or shipment of the instrument for repair to Antec or its representatives. When shipped to Antec every instrument has to be accompanied with a decontamination form which should be completely filled in and signed by the customer. Without this decontamination form the instrument will not be processed by Antec (either repaired or disposed).



Waste disposal

Perform periodic leak checks on LC tubing and connections. Do not close or block the drain in the oven compartment. Do not allow flammable and/or toxic solvents to accumulate. Follow a regulated, approved waste Disposal program. Never dispose of flammable and/ toxic solvents through the municipal sewage system.



Applications: quality control

It is recommended that you routinely run several quality control samples. Quality control samples should represent low, average and high levels of a compound. Make sure that quality control sample results are within An acceptable range, and evaluate precision from day to day and run to run. Data collected when quality control samples are out of range may not be valid. Do not report this data until you are certain that system Performance is acceptable. Apart from use of quality control samples, we Recommend that you use blanks. The blanks will help you assess whether carry-over is within an acceptable range and monitor the integrity of your data.



Using the DECADE Elite in other ways than indicated in the manual or defined by good laboratory practice may result in erratic or unsafe operation.

CHAPTER 1

Introduction

Congratulations on your purchase of the DECADE Elite. This detector enables you to perform all (U)HPLC applications using electrochemical detection. The DECADE Elite includes a highly stable Faraday-shielded oven compartment accommodating column and flow cell. This flow cell has surprised researchers for its unsurpassed S/N ratio and therefore you now possess the best possible combination for extremely sensitive EC analyses.

The DECADE Elite has 3 operational measurement modes: DC, SCAN and PULSE mode. Furthermore, a Service, Diag(nostics) and Config(uration) mode are available. In addition, crucial parameters can be controlled by either relays or TTL. The DECADE Elite can support up to 4 flow cells (optional), which makes it possible to perform 4 independent measurements with one detector.

The DECADE Elite is available in different colors. The DECADE Lite is a “light” version of the Elite, it is for single flow cell operations in DC mode only.



This manual covers the installation, set-up and operation of the DECADE Elite only. Detailed operation instructions for other peripheral LC equipment and parts such as flow cells, pumps, autosamplers, valves, column heaters etc. are given in the manuals accompanying those accessories.

Instrument description

DECADE Elite – Front side



#	Description	#	Description
1	Instrument housing	7	'+' and '-' value keys
2	LC tubing inlet/outlet	8	Cursor keys
3	Instrument door panel	9	Door handle (for opening door)
4	4 x 40 Ch LCD display		
5	Function keys		
6	<Enter> key		

DECADE Elite – Back side



#	Description	#	Description
1	Instrument rear panel	7	USB connector (USB B)
2	Type label (pn, sn etc.)	8	Fuse & power rating
3	Digital I/O connector (25-pins sub-D fem)	9	Mains switch/inlet
4	Analog data (9-pins sub-D fem)	10	Grounding stud
5	Valve connector (9-pins sub-D male)	11	Fuse compartment
6	LAN connector (RJ45 jack)	12	Ventilation holes

DECADE Elite – Oven compartment



#	Description	#	Description
1	Cell cabinet	8	Column clamp
2	Cell connector (9-pins sub-D fem)	9	Mounting hole for cell clamp (M4)
3	Top fan heater (intake)	10	Bottom fan heater (exhaust)
4	Door sensor	11	Mounting hole for column clamp (M3)
5	Mounting plate (for cells & columns)	12	Fuse compartment
6	Door lock	13	Door panel, rear
7	Flow cell clamp (for SenCell)	14	Type label

CHAPTER 2

Installation

Site Preparation Requirements

For a successful onsite installation of the instrument, please arrange the following requirements at your location in advance:

Personal Computer

In case the instrument is used via remote control by PC software (Dialogue, Clarity) or firmware (FW) update needs to be performed a desktop computer is required with the following requirements:

- Free LAN port (onboard, PCI, PCI express or PCI-X)
- Free USB port (required for FW updates)
- Microsoft Windows 7 Operating System or higher

Detailed requirements for use of the DECADE Elite in combination with Clarity chromatography software are listed in document 195.7000 Computer requirements which can be downloaded from the Antec website (www.myantec.com).

Laboratory requirements

Your instrument is intended for indoor use only in an industrial or commercial environment (EN55011 group 1 class A ISM equipment). It is suitable for the following categories: Installation category II, Pollution degree 2, equipment class I.

Table 1. Environmental specifications

Parameter	Requirement
Operating temperature	10 – 40 °C (50 – 104 °F)
Operating humidity	20 – 80%, non-condensing



For optimum analytical performance it is recommended that the ambient temperature of the laboratory be between 20-25 °C and be held constant to within ± 2 °C throughout the entire working day. Note: that for optimal temperature stability of the cell cabinet the oven temperature should be set to a temperature at least 7 degrees higher as ambient temperature.

Requirements for the laboratory bench on which the instrument will be installed:

- Stable, clean, flat and smooth surface.
- Enough mechanical strength to hold at least the weight of the detector: a full-dressed detector with flow cells, columns and valves can weigh up to 20 kg.
- A detector has the following dimensions 44 (D) x 22 (W) x 43 (H) cm = 17.3" (D) x 8.7" (W) x 16.9" (H). Take into account that additional space is necessary on all sides (at least 10 cm) to prevent obstruction of ventilation holes and allow sufficient heat dissipation.

Chemicals

Mobile phase and flush/storage solutions must be clean as it is in direct contact with the working electrode in EC detection. High purity chemicals including water is a prerequisite. So all chemicals should be electrochemically clean, HPLC grade or better. For water used for the preparation of mobile phases a water purification apparatus is advised which is able to supply high purity deionized water with resistivity of >18 MOhm.cm and low TOC level (<10 ppb).

Unpacking

Inspect the *transport box* for possible damage as it arrives. Immediately inform the transport company in case of damage, otherwise she may not accept any responsibility. Keep the transport box as it is designed for optimum protection during transport and it may be needed again. Carefully unpack the system and inspect it for completeness and for possible damage. Contact your supplier in case of damage or if not all marked items on the checklist are included. Prior to shipment, your detector has been thoroughly inspected and tested to meet the highest possible demands. The results of all tests are included.

See check list below for reference:

- | | | |
|-----|---|-----------------------|
| (1) | Delivery is in accordance with order | <input type="radio"/> |
| (2) | Delivery is undamaged | <input type="radio"/> |
| (3) | All items on checklist(s) are included | <input type="radio"/> |
| (4) | Certificates of performance are included: | |
| | - detector | <input type="radio"/> |
| | - flow cell(s)* | <input type="radio"/> |
| (5) | User manual(s) is (are) included on USB stick | <input type="radio"/> |

*) Note that flow cells are not part of the DECADE Elite detector and have to be ordered separately.

To unpack the DECADE Elite, lift it from its box by both hands (Fig. 1). **Never lift the DECADE Elite at its front door, but at its sides.**

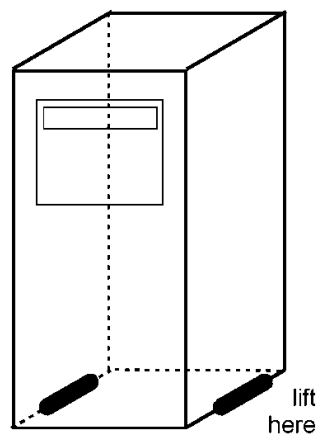

Fig. 1. Lift instructions DECADE Elite.

With both hands under the instrument lift the DECADE Elite to its operation location. Install the detector in an area which meets the environmental conditions.

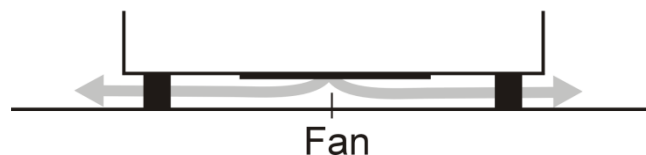

Fig. 2. Location of power supply fan DECADE Elite.

Remove the protective tape from the DECADE Elite LCD screen. Leave the instrument to adopt ambient temperature for at least half an hour in the place of installation.



Use the detector indoors only. Place the detector upright (on its instrument feet) on a stable, flat and smooth surface. Do not place the instrument in an area subject to excessive dust or shocks. Do not place it near a source of heat or in direct sun light, as this may influence the heating capabilities of the instrument. Make sure the detector is placed in such a way that the mains power connection can be reached easily to disconnect it from the mains power by removing the Mains power cable. Do not block the ventilation holes at the back of the instrument and do not block the fan located at the bottom of the detector (Fig. 2.). Blocking the fan will impair the cooling capability of the power supply.

Do not place object/instruments on top of the DECADE Elite. Objects can be placed on any side of the detector; however, make sure these objects are placed at a distance of 5 cm from the DECADE Elite, if objects are placed at only one side of the instrument and 10 cm from the DECADE Elite, if objects are placed on more than one side of the instruments.

Mains connection

Check that fuses and voltage range on the rear side of the instrument match that for the power outlet to be used.



This device complies with the requirements of EN 55011 group 1 class A ISM equipment. In a domestic environment this product may cause radio interference in which case the user may be required to take adequate measures on his own expenses. Understanding power surges. Power surges, line spikes, and transient energy sources can impede instrument operation. Ensure that the instrument's electrical supply is adequately protected from these conditions and properly grounded. If necessary connect the instrument to a filtered mains inlet.



Power supply and protective earth: The system must be connected to a suitable mains power supply with a correctly installed protective earth conductor. Never use the system without a properly connected protective earth conductor.

Leave the instrument powered off until specifically mentioned in the procedure below.

PC connection

Follow the instructions in this paragraph when the instrument is used with PC control over LAN using the Elite Dialogue or Clarity Chromatography Software. This section can be skipped if the instrument is used stand-alone. To be able to communicate over LAN a computer is required with a free (PCI, PCI Express or PCI-X) LAN port.

The DECADE Elite has a fixed IP address: 192.168.5.1, with subnet mask: 255.255.255.0. Gateway and DNS are not filled in.

The instrument is standard delivered with a special crossover LAN (UTP) cable (pn 250.0170) which is part of the DECADE Elite accessory kit (pn 175.0200). If the instrument is delivered as a part of a complete ALEXYS (U)HPLC-ECD system an additional LAN connectivity kit (pn 250.0180) which consist of a set of network cables and a pre-configured broadband router is available.



To insure stable and error-free communication only use the manufacturer-supplied LAN connectivity kit to connect the DECADE Elite to LAN. Create a small dedicated local area network to connect the DECADE Elite to the PC. Do not connect the DECADE Elite over a company Local Area Network. If needed a second network adapter with a different (unique) IP address range can be applied.

In the following section the procedure to connect the instrument to the PC using the crossover UTP cable is described. Configure the IP address of the PC LAN network card by executing the following steps (in this example the Windows 7 OS is used, in Windows 8 the example screens may look different):

1. Right click on the Network icon in the bottom right of the Windows taskbar and open the menu 'Open Network and Sharing Center'. Alternative: open Windows start menu, open control panel and goto 'Open Network and Sharing Center':

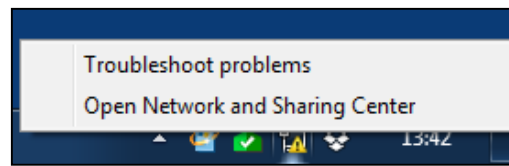

2. Open the menu 'Change adapter settings' on the left panel of the 'Open Network and Sharing Center' window.

3. Right click on the Local Area Connection icon of the LAN card in your PC and click on properties to open the Network card setting.

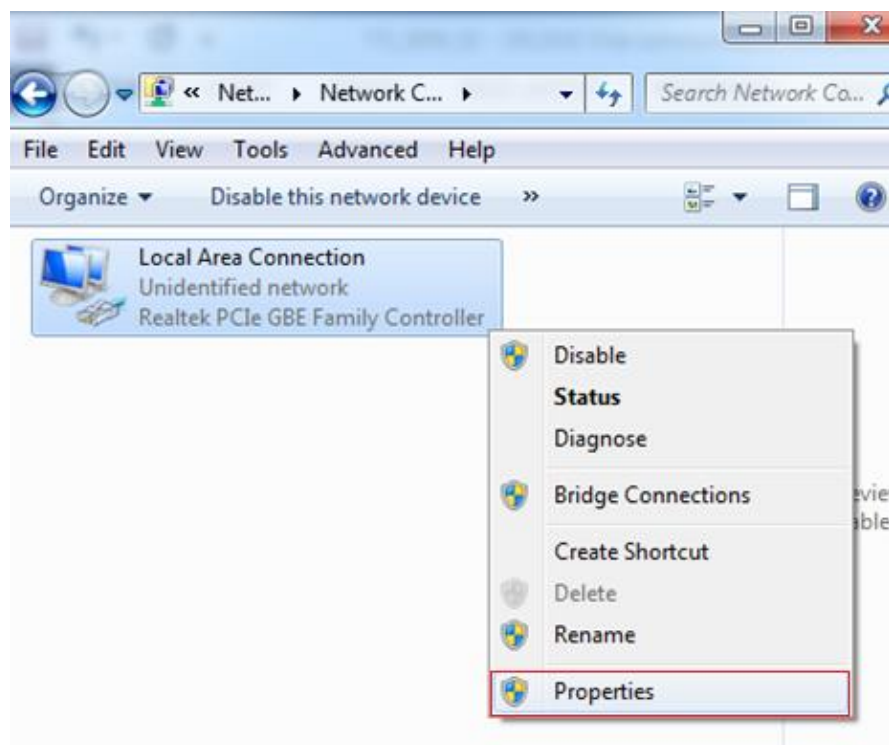

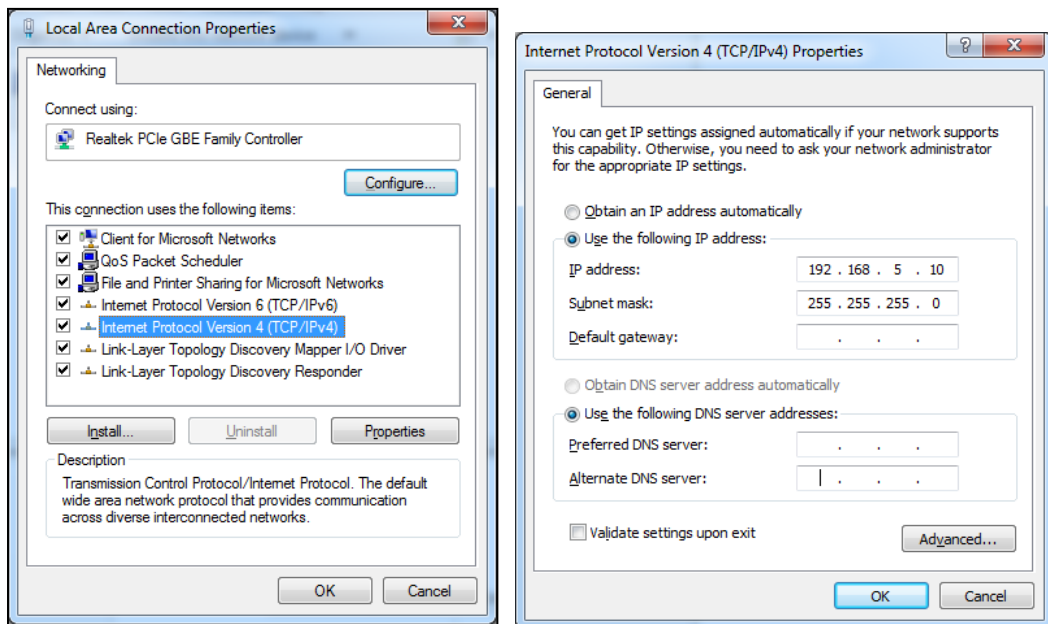

4. Open the menu 'Internet Protocol Version 4 (TCP/IPv4)' menu (double click).
5. Configure the network IP address and subnet mask as depicted in the screen dump below (IP 192.168.5.10, Subnet mask: 255.255.255.0). Gateway and DNS fields are not filled.
6. Close the menu(s) by clicking the 'OK' buttons. The network IP address of the LAN network card is now set up for communication with the DECADE Elite.
7. Connect the crossover (UTP) cable to the RJ45 Jack of the LAN card of your PC (typically located on the backside of a desktop PC).
8. Connect the other end of the crossover LAN (UTP) cable to the LAN port on the rear panel of the DECADE Elite as depicted on the photograph.
9. Switch on the DECADE Elite. Set the detector temperature to 35°C if a Performance Qualification (PQ) will be executed, or set it to the temperature at which your application is running. Allow the instrument to stabilize for at least one hour before starting analysis. The PQ and OQ are described in separate manuals available on the Antec website.

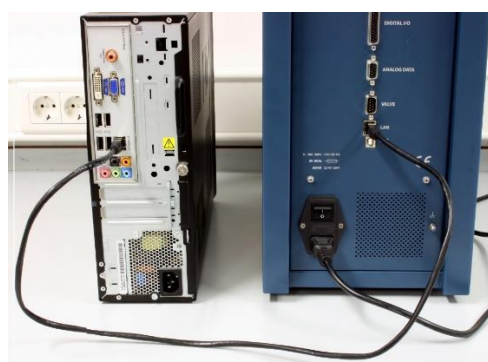

Fig. 3. Example of LAN connection between PC and DECADE Elite. A direct connection requires the special crossover UTP cable. With a switch any regular UTP cable can be used.

Software

The DECADE Elite can be used in combination with PC control software. Currently, there are two software packages available for control and data-acquisition of the DECADE Elite electrochemical detector:

- Elite Dialogue software from Antec, The Netherlands.
- Clarity chromatography software (Version 6.x and higher) from DataApex, Czech

The Elite Dialogue software is also required for the upload of new firmware (= embedded software controlling the DECADE Elite electronics). In this section the installation and configuration of the DECADE Elite is shortly described. Note: this is by no means a replacement of the installation documentation available for the software packages. Please refer to this documentation for details.



Ensure you have Administrator access rights in your system before you start with the installation of the software packages. Elite Dialogue and Clarity users must have read/write access to all software folders and subfolders.

Elite Dialogue

To install the software:

- Download the latest version of the Elite Dialogue from the Antec website www.myantec.com (register to get access).
- Double click on the setup.exe file to start the installation wizard
- Follow the instructions of the installation wizard for successful installation of the software.
- Insert the Elite Dialogue license dongle to get full access to the software (without dongle it will operate in demo mode).
- Make sure that the LAN connection is configured and the LAN cable is connected.
- Power up the detector by means of the mains switch on the rear panel.
- Start the program Elite Dialogue from the Windows start menu.
- During start-up the 'Select devices' menu will pop-up as shown below.

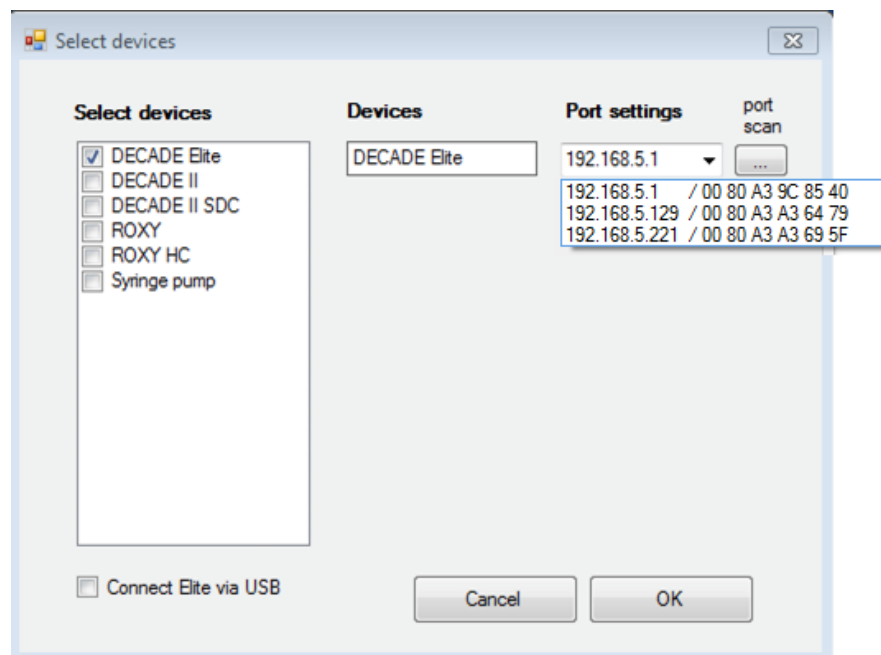

- When a DECADE Elite is available it is automatically detected and the IP address is shown in the port settings box. If not press port scan or type in the default IP address 192.168.5.1.
- The pull down field shows all responding devices with their IP and MAC address. In case of doubt check the device unique MAC address on the rear panel IO connector.
- Type OK. The instrument will connect and is ready for use.

Clarity Chromatography software

In the case an ALEXYS Analyzer was purchased which includes preconfigured Clarity software installation files please refer to the installation information shipped with the ALEXYS system, otherwise see instruction below to install the software:

- Open the official installation DVD of the Clarity Chromatography software.
- For disk space requirements and detailed installation information see the official Clarity 'Getting Started' manual. It is available on the installation DVD.
- Select the INSTALL.EXE file and double click it (if installation does not automatically start).
- The software installation wizard will guide you through the installation process including creation of a Clarity menu in the Windows start menu and a Clarity quick start icon on the PC desktop.
- When asked during the installation fill in the license key code of the Clarity license dongle purchased. To be able to control the DECADE Elite you need to have at least the following Clarity modules: single instrument SW module + the LC control module.
- Insert the license dongle.
- Make sure that the LAN connection is configured and the LAN cable is connected.
- Power up the detector by means of the mains switch on the rear panel.
- Start Clarity by double clicking on the quick start icon on the desktop.
- Open the 'Configuration' menu from the 'system' pull-down menu in the Clarity main window:
- Add (button bottom left field) the DECADE Elite control module (listed under detectors).

- The detector set-up menu will open (see figure on the next page). Select LAN communication (checkbox) and fill in the IP address 192.168.5.1.
- By clicking 'Auto detect' the instrument will be automatically connected and the number of available sensor boards shown.
- Set the desired heater temperature. For valve control check the 'valve connected' box.

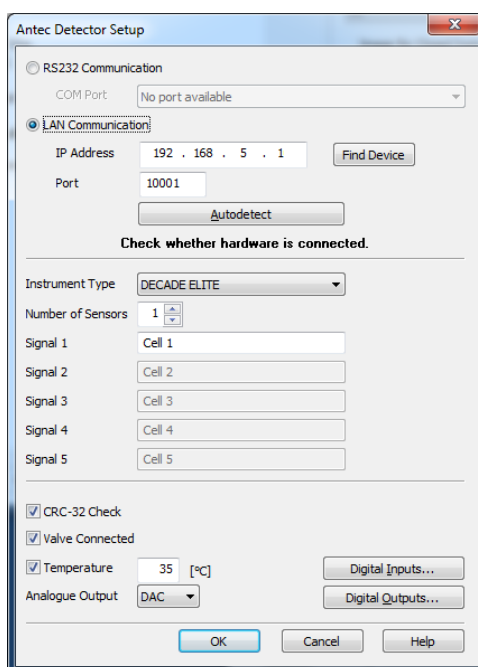

- The instrument has a CRC-32 check on the data communication to correct for transmission errors. It is advised to have the CRC-32 check switched on.
- For use of the analog start trigger to start a run using an external device, open the 'Digital Inputs' and select 'Sensor 1 – start in'.

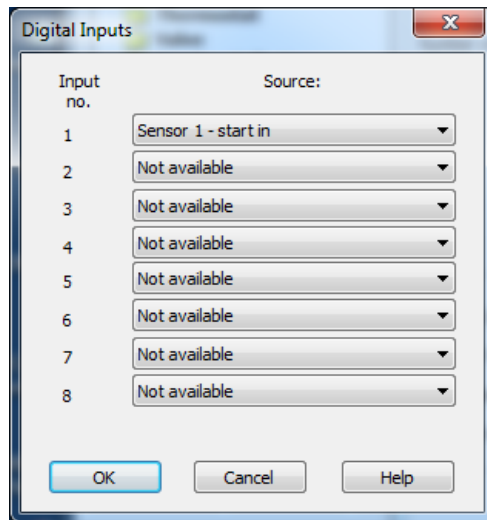

Connect the relay (contact closure) of the external device which functions as inject trigger to the 'digital IO connector on the rear panel of the detector to pin 21 (start 1) and pin 25 (ground). For sensor board 2 or 3 use pin 22 (start 2) and pin 23 (start 3) respectively.

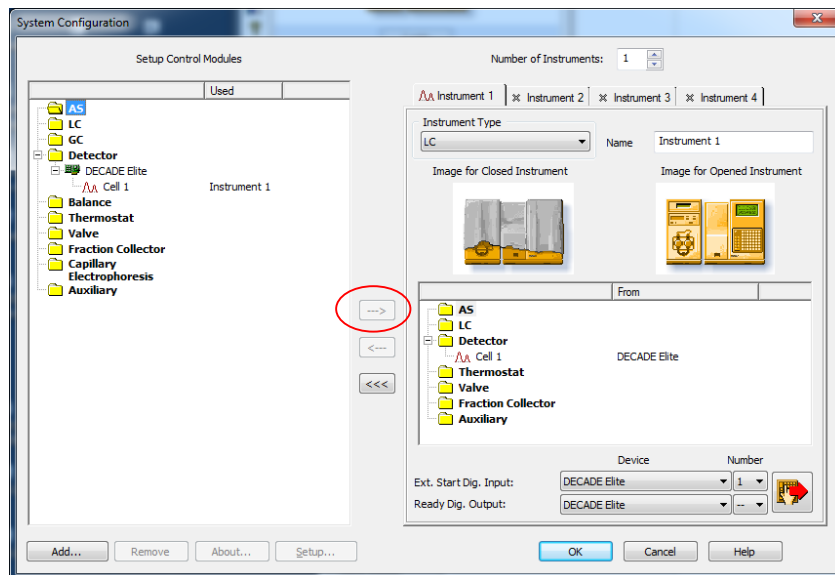

- Add the DECADE Elite device to the Clarity instrument by clicking the right arrow button (encircled) and select Ext. Start. Dig. Input 'Device DECADE Elite, Number 1' to enable an external start trigger.

- In case an ALIAS, SINEAS, AS 110 auto sampler is used to trigger a run digitally (via RS232, LAN, USB etc) please refer to the corresponding Clarity instruction manual of the specific control module.
- Type OK and login to your Clarity instrument to connect and the DECADE Elite is ready for use.

HPLC fluid connections

In this section the installation & priming of all relevant fluidic connections are described to be able to use the DECADE Elite for the analysis of substances with (U)HPLC-ECD. When working with HPLC solutions and mobile phases take the following precautions:



Use proper eye and skin protection when working with solvents. The solvents used may be flammable, toxic or corrosive. Organic solvents are toxic above a certain concentration. Ensure that work areas are always well-ventilated! Use of open fire in the vicinity of this system must be strictly prohibited. Do not install the system in the same room with any other equipment that emits or could potentially emit sparks. Wear protective gloves, safety glasses and other relevant protective clothing when working on the device!

With respect to third-party (U)HPLC equipment, such as LC pumps, auto samplers, injection valves, column heaters etc. used in combination with the DECADE Elite Detector. The equipment connected to the system should be specifically designed for use in (Ultra) High Performance Liquid Chromatography and capable of delivering flow rates typically in the range between 1 μ L/min up to 5 mL/min.



The manufacturer will not accept any liability for damage, direct or indirect, caused by connecting this instrument to devices that do not meet the relevant safety standards.

Tubing connectors

For optimal operation it is of the utmost importance that all tubing connections on the injection valve, columns and flow cells of the injection valves are made without introducing dead volumes to minimize peak broadening, carry-over etc.



Use only the original polymeric fingertights supplied by Antec with the purchased flow cell to make LC connections on the flow cells inlet and outlet. Do not use metal tubing on the flow cell because it may lead to damage or incorrect operation of the flow cell. Use PEEK, PEEKsil or Fused Silica tubing (with FEP sleeves).

For columns and injection valves etc. use only nuts, ferrules or finger tights recommend by the respective manufacturer of the parts. So for Vici Valco valves use Valco nuts and ferrules, for Rheodyne valves use Rheodyne valves etc. The use of unsuitable connectors may lead to damage of the parts or the introduction of dead volumes. In case the DECADE Elite was purchased as a part of an ALEXYS HPLC-ECD analyzer, the instrument is shipped with a complete set of dedicated tubing assemblies (LC connection kits) tailor-made for the application the analyzer was specifically defined for.

Please note that the tubing length (length L below) required to make a good connection differs for each brand of connection. If length L is not correct, this will result in faulty peaks and carry-over. Essentially, when you create a connection the ferrule on the tubing is compressed into the valve to make sure that the connection is leak-tight. Take the following into account when creating the connection:

If L is too long, the ferrule cannot form a seal in the connection. This may cause

Irreparable damage port of the valve, column or other part, as:

- Part of the tubing may end up in the connection port internals
- Internals of the port may be damaged.

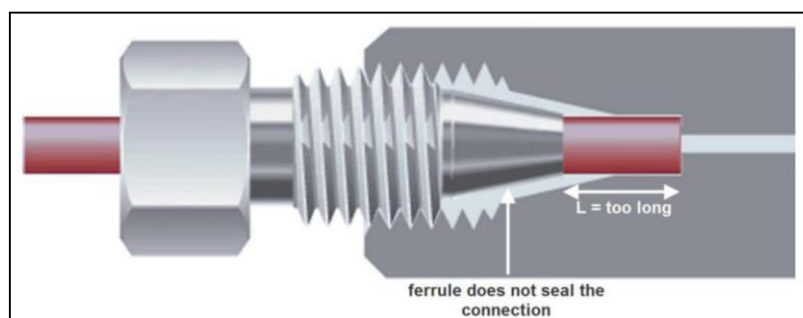

If L is too short, this may result in:

- Leakage
- Dead volume at the end of the ferrule (a 'mixing chamber').

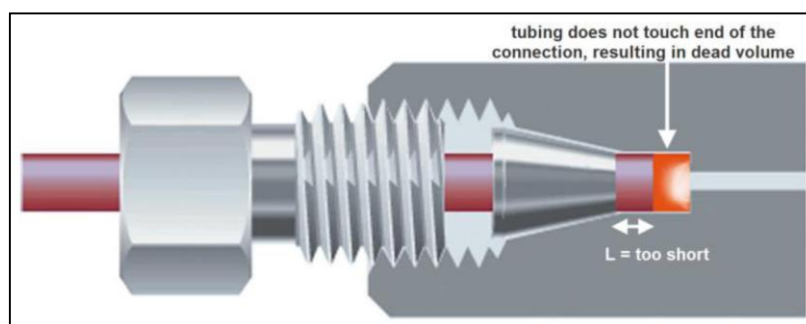

Every ferrule type needs an appropriate length of tubing for connecting it to the type of connection port, depending on the depth of the connection port. Refer to the information provided by the manufacturer for specific information.

Mobile Phase

Electrochemical detection is a sensitive detection technique characterized by extremely low detection limits. A typical detection limit of 100 pmol/L or lower for catecholamines is no exception. Improving detection limits will always be limited by the weakest link in an LC-EC system. In daily practice a couple of 'rules' must be obeyed to fully exploit the incredible linear dynamic range and low detection limits of an EC detector. These are not only hardware related, but also refer to mobile phase composition, degassing, temperature and pH stability and several other issues.

Mobile phase requirements:

- Electrochemically clean, HPLC grade or better
- Ion strength 20 - 200 mmol/L
- Buffer pH near pKa
- In-line 0.2 μm filter & degassing of mobile phase
- EDTA for trapping of metal ions

Mobile phase must be clean as it is in direct contact with the working electrode in EC detection. High purity chemicals including water is a pre requisite. In some applications EDTA is added to the mobile phase to traps electrochemically metals such as Fe^{2+} by forming an inactive complex.

However at higher working potentials (typically > 1.2 V vs. salt bridge AgCl ref) also EDTA can become electrochemically active and is not recommended. In that case only a passivation step with 15% HNO₃ is recommended (see installation guide).

Electrolytes assure contact between 3 electrodes in an electrochemical flow cell. Low ion strength destabilises an EC system and noise will increase. Extremely high buffer concentrations cause problems of salt formation. Therefore concentrations between 20 and 200 mmol/L are recommended.

Also constant pH is important for baseline stability and reproducible results. Stability of pH is best when close to pK_a of a buffer ion. Often used buffers are phosphate, carbonate, acetate and citrate. Modifiers such as methanol, propanol and acetonitril can be used without problems in DC amperometry, but not in pulsed amperometric detection as peaks are strongly attenuated. In our experience the quality and expiration date of organic modifiers can be a problem resulting in increased noise levels. Metal inlet frits in mobile phase bottles are not advised as metal ions are introduced that increase baseline noise. Instead 0.2 µm nylon inlet filters are recommended.

Vacuum degassing: Considerable amounts of the gases N₂, O₂ and CO₂ may be dissolved in HPLC mobile phases. Whenever the temperature changes, solvents are mixed or a pressure reduction occurs, these gases may show up as very small air bubbles. To avoid noisy baselines an in-line vacuum degasser has been integrated in the ALEXYS analyzer/ ROXY EC/LC system. It has a low dead volume (less than 0.5 mL) and high degassing efficiency. The advantage over helium degassing is that the degasser does not change the mobile phase composition.

Helium degassing: Degassing using helium is an effective and universally applicable method but only recommended when working in reductive electrochemical detection and pulsed electrochemical detection (analysis of carbohydrates using anion-exchange chromatography with NaOH as mobile phase). All gases except helium are removed completely. Helium is not EC active and does not change the mobile phase properties significantly. To prevent mobile phase contamination, only high-purity helium must be used.

Installation & start-up

Please carefully follow the next steps for a successful installation and start-up:

1. The installation of the flow cell and column is shown in Fig. 4.
2. If a manual injector is applied with position sensor, the sensor cable must be connected to the VALVE connector on the rear panel to enable INJECT/LOAD functions. In the CONFIG screen the valve option should be set to 'Valve = present' manually.
3. An electrically actuated valve of Vici Valco (type E2CA, EHCA) can be connected & controlled by the DECADE Elite. For that purpose a serial valve cable is required. The serial cable should be connected to the VALVE connector on the rear panel of the instrument to enable INJECT/LOAD functions. This presence of this valve is automatically detected and no further configuration has to be performed.

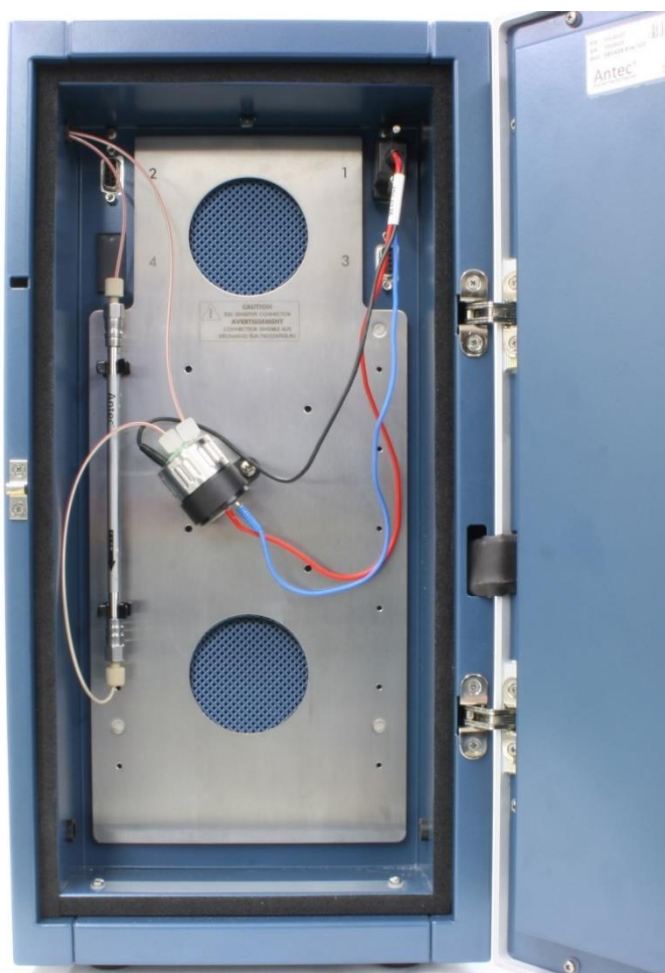

Fig. 4. Installation of flow cell and column in the DECADE Elite.

- Prior to connection of the HPLC system to the detector all metal parts should preferably be passivated with 15% nitric acid during 20 min. The acid is flushed through the pump, the pump tubing, the dampener, the injector (in load and inject position) and to waste



Make sure that all parts that are not acid-resistant such as: nylon inlet filters, column and flow cell are *not* connected during this step.

- After flushing with nitric acid, the system must be thoroughly flushed with demi water. Make sure that no traces of nitric acid are left in the tubing or pulse dampener (check with pH paper). Flush the system with HPLC buffer.



If an ISAAC™ reference electrode is used, make sure that the mobile phase contains at least 2 mmol/l chloride (KCl or NaCl) ions.

- Before connecting a new column read the manufacturer's instructions. Our experience is that thorough pre-conditioning of a column is always required. Only a pre-conditioned column is electrochemically clean. If not, the background current may be unacceptably high and substantial fouling of the working electrode occurs. For *reversed phase* columns flushing with 50% methanol in water for 3 days at a low flow rate is highly recommended. Before switching to mobile phase, flushing with water (10 column volumes) is recommended to prevent precipitation of buffer salts.
- Passage of air bubbles through the flow cell will lead to unacceptable noise levels and 'spikes'. Therefore, the use of an in-line degasser is strongly recommended. In our experience, a one-time degassing step of the HPLC buffer is almost never sufficient. If the DECADE II is used for reductive ECD (at a negative working potential) additional steps should be taken to remove oxygen from the mobile phase. These include degassing with Helium and the use of stainless steel tubing (impermeable for oxygen).
- Consult your flow cell manual for detailed information about the installation of the flow cell. See figure 11 on the next page for reference. Connect the flow cell to the corresponding cell connector in the oven compartment. All cell connectors are marked with a label for identification. In case of a DECADE Elite

SCC connect the flow cell to the cell connector on the left side marked "Cell 1".



The cell connector inside the oven compartment is ESD sensitive. Make sure that the flow cell is OFF when removing or connecting the cell cable.

Never switch ON the flow cell when: (1) the cell cable is not correctly connected, (2) the cell is only partly (or not at all) filled with mobile phase, (3) the outside of the flow cell is wet, particularly the part between the auxiliary and working electrode connection, because substantial damage to the working electrode or electronics may occur.

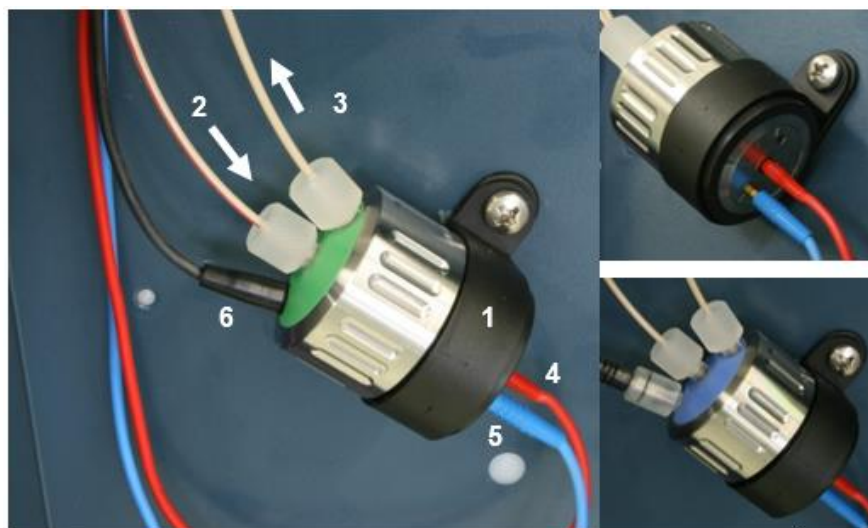

Fig. 5. Left: SenCell with ISAAC reference mounted under an angle of approximately 45° in the detector. [1] Cell clamp, [2] Cell Inlet (tubing connection from column-to-cell), [3] Cell outlet (tubing connection from cell-to-waste) make sure that the outlet is positioned on the top side to prevent entrapped air bubbles, [4] WE contact (red), [5] AUX contact (blue), [6] REF contact (black). Top-right: electrical connections of WE (red connector) and AUX electrode (blue connector). Bottom-right: SenCell with SaltBridge reference electrode.

9. Before switching ON the flow cell, make sure that the mobile phase contains sufficient electrolyte (buffer ions). A stable baseline will never be obtained if the cell is switched ON with only

water or another non-conducting mobile phase. Also be sure that no air bubbles are trapped in the flow cell.

10. The outlet tubing from the flow cell should lead to a reservoir that is at a higher level than the flow cell. This ensures a small back pressure which prevents air-bubble entrapment. The outlet tubing should be *under* the liquid level, to avoid electrical noise induced by 'dripping' of mobile phase.
11. Set the cell potential (see page 83 for optimization of the potential), switch ON the flow cell and allow the system to stabilize for approximately 30 min. A 'good' stabilization curve shows a mono-exponential decline without jumps and/or spikes.
12. Connect the DECADE Elite to the PC control software (Clarity or Elite Dialogue). In the case the instrument is used stand-alone connect an external A/D converter or recorder to the 'Analog data output' (1 V full scale) on the rear panel. Refer to the documentation of the third-party software controlling the A/D converter for detailed instruction how to set up a measurement with the A/D device.

Your system is now ready for use. The DECADE Elite has been developed for continuous operation. For maximum stability it is advised to leave the system ON continuously. If preferred, the flow cell may be switched OFF at night.

CHAPTER 3

Maintenance & Shutdown

Maintenance

In this paragraph all maintenance is described which can be performed by the end-user, all other maintenance & service procedures may only be performed by authorized service engineers only.

Periodic check for leakage

Perform leak checks on LC tubing, flow cells and connections on a daily basis and check if the drain on the bottom of the oven compartment is not blocked or closed. Do not allow flammable and/or toxic solvents to accumulate. Follow a regulated, approved waste disposal program. Empty and clean waste container regularly. Never dispose of such products through the municipal sewage system. Check daily that the mobile phase bottles contain enough mobile phase for the number of analysis planned to be Executed.

Periodic check of the oven temperature

The operator should perform regular checks to verify if the actual oven temperature is in accordance with the set temperature of the DECADE Elite.



In case the actual temperature exceeds 70°C switch off the detector and contact the manufacturer or its representatives for service.

Flow cell

Check the performance of the detector & flow cell on a daily basis by evaluating background current, noise and signal. An increase in background current, noise and/or loss of sensitivity may be a sign of contamination of the working electrode (WE) and/or a sign that maintenance is required on the reference electrode (REF) of the flow cell. If necessary perform maintenance on the flow cell. Detailed information about flow cell maintenance instructions are described in the user manual supplied with the specific flow cell (SenCell, VT-03 or FlexCell) purchased in combination with your detector.



Cleaning

In general, the DECADE Elite needs very little maintenance. The outside of the detector may be cleaned with a non-aggressive cleaning liquid.



Do not use any organic solvents to clean the exterior of the detector, because this may lead to damage of the paint layer.

In case of leakage in the cell cabinet (tubing, connectors, cell, column etc.) remove the spilled mobile phase or other solutions as soon as possible because this may damage the paint layer, or result in the deposition of salt crusts (in case of buffered mobile phases), which could block the drain in the bottom of the cell cabinet. Remove any dust on the protective screens that cover the fans in the oven compartment.

Replacement of fuses



Replace blown fuses with fuses of proper type and rating as stipulated on the rear panel and specified in the installation section of this manual. The fuse holder is integrated in the mains connector. Ensure that the instrument is never put in operation with fuses of a different type. This could cause fire.

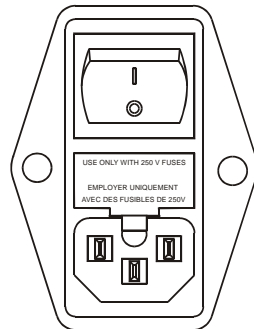

V ~ 100-240 V	FUSE RATING	 WARNING - RISK OF FIRE REPLACE FUSE AS MARKED AVERTISSEMENT - RISQUE DE FEU REMPLACEZ LE FUSIBLE COMME INDIQUÉ
50 - 60 Hz		
260 VA	2.5AT / 250V	

In case the fuses blow out repetitively contact Antec or its representatives for instructions and/or service of the instrument.

Shutting down the system

There are a couple of steps to take to switch off an LC system with electro-chemical detector for a longer period of time. Shutting down is not different from most other HPLC systems. Perform the following procedure:

- Switch off the flow cell using the keyboard (standalone) or via the software (Clarity or Elite Dialogue).
- Check the column(s) documentation for the appropriate storage liquid, apply this and make sure the column is properly flushed. A reversed phase C18 column is usually stored with 50% Acetonitrile/water.
- Take out the column, mount the corresponding end-caps and store the column in an appropriate place.



Avoid precipitation of high salt concentrations in organic solvent, first wash out salts with water if necessary.

- Flush and store the system with 50% water/acetonitrile (or methanol). Switch the injector valve between load and inject a few times. Make sure all tubing, filters etc are flushed so no traces of salt are left that could precipitate and clog the system.
- Remove the flow cell from the system by disconnecting the inlet and outlet capillary.
- Open the cell, flush with water, use some tissues to carefully dry the cell. Be careful not to damage the spacer in the case of a VT-03 or FlexCell (the SenCell does not have a spacer).
- Close the cell and store dry. In case of salt bridge REF, store the REF separately with a cap on it to prevent drying out. Alternatively, put the sb-REF in a 10 mL vial under a KCl solution and close the vial with a cap.
- Switch off the detector (and other LC equipment) via the mains switch (switch to position '0') on the rear panel.

CHAPTER 4

DECADE Elite controller

Introduction

The DECADE Elite has been designed for maximum functionality and ease of use. The control of ECD parameters is such that without reading this chapter, it should be possible to operate the detector. This chapter is intended as a reference guide in case questions arise during operation. The information shown in the numerous screens is presented in alphabetical order. For each item an explanation is given, together with the item's nature and the screen(s) of appearance. The nature of an item can be:

1. Control: parameters with a cursor box ('□') can be attained via cursor buttons and changed by the 'value' button.
2. Status: without a cursor box a parameter reflects the current status.
3. Functions: parameters in CAPITALS are commands accessible via function buttons F1 - F5.
4. The 'Enter' button is only used to accept changes in cell potential. In the top right corner of each screen the name of the present screen is displayed. If available, the bottom left function button displays a previous screen, and the bottom right one the next screen.



Fig. 6. DECADE Elite keyboard. The cursor is on 'Range' which allows changes using the value buttons '+' and '-'. The 'Enter' button is only used to confirm changes in potential (Ec) and range.

Overview of DECADE Elite screens

DC mode

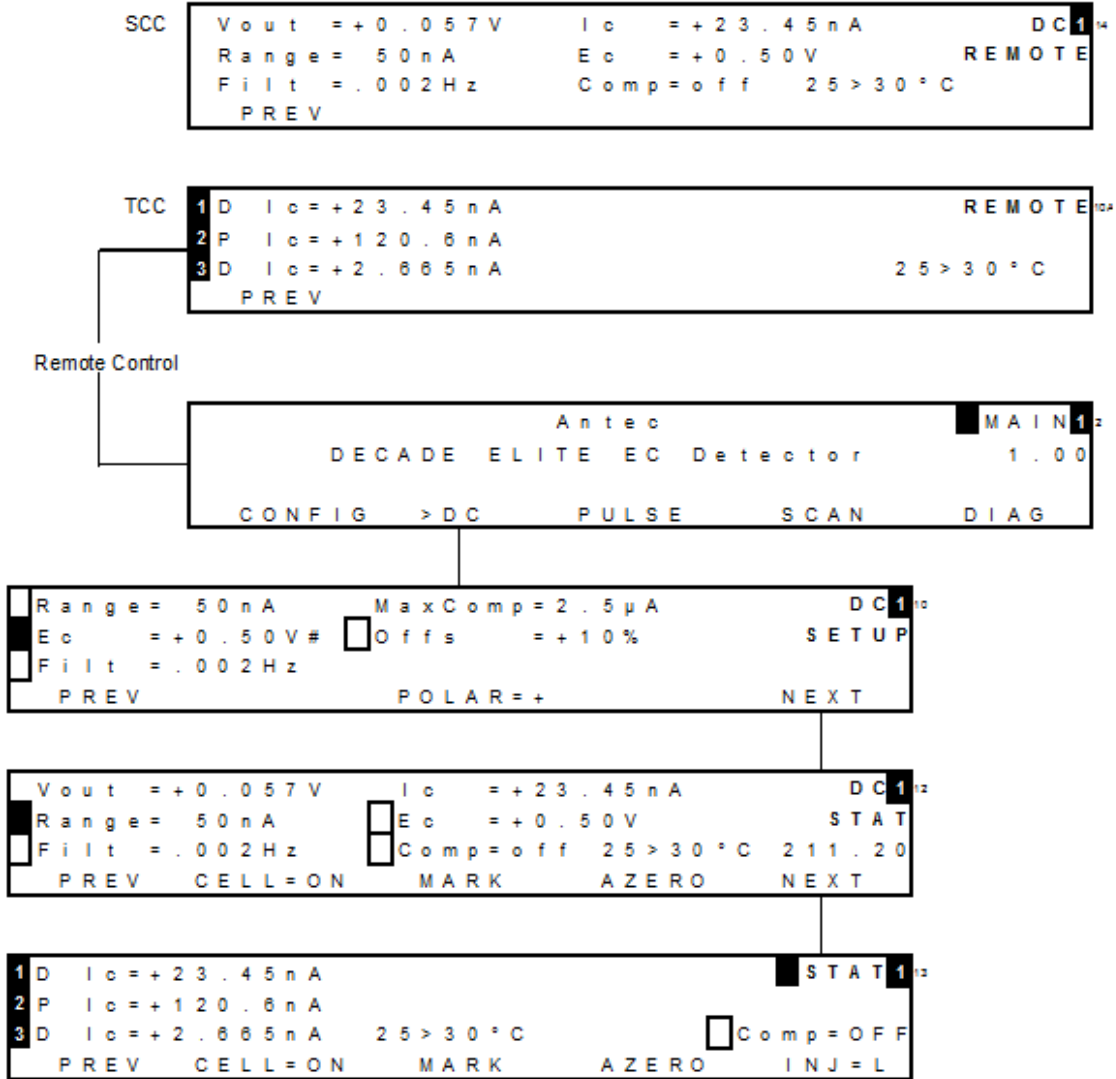

Pulse mode

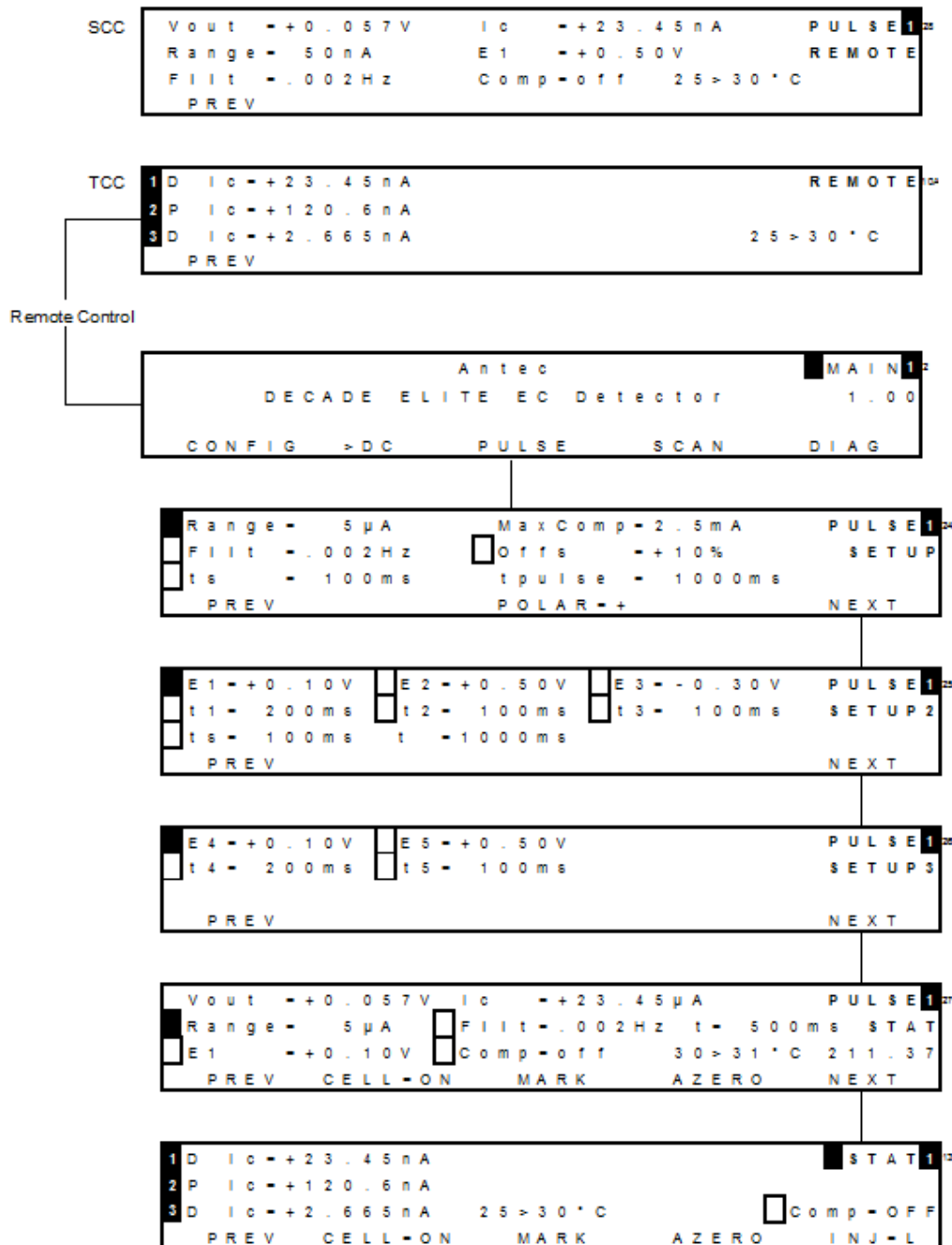

SCAN mode

SCC Vout = +0.057 V Ic = +23.45 nA SCAN 1³⁶
 Range = 50 nA Ec = +1201 mV REMOTE
 Comp = off 25 > 30 °C
 PREV

QCC 1 D Ic = +23.45 nA 4 S Ic = +1.50 mA REMOTE 10A
 2 P Ic = +120.6 nA
 3 D Ic = +2.665 nA 25 > 30 °C
 PREV

Remote Control

Antec MAIN 1²
 DECADE ELITE EC Detector 1.00
 CONFIG > DC PULSE SCAN DIAG

E1 = +0.20 V E2 = +1.20 V SCAN 1³³
 Range = 50 µA Spd = 100 mV / s SETUP
 Offs = +10% Cyc = cont
 PREV CELL = OFF NEXT

Vout = +0.057 V Ic = +23.45 µA SCAN 1³⁴
 Range = 50 µA Cyc = cont E1 = +0.20 V STAT
 Offs = +10% 30 > 30 °C E2 = +1.20 V
 PREV START CELL = ON NEXT

Vout = +0.057 V Ic = +23.45 µA SCAN 1³⁵
 Range = 50 µA Cyc = cont Ec = +1201 mV STAT
 Offs = +10% 30 > 30 °C SPD = 0.1 V / s 00 : 21
 PREV STOP HOLD

CONFIG menu

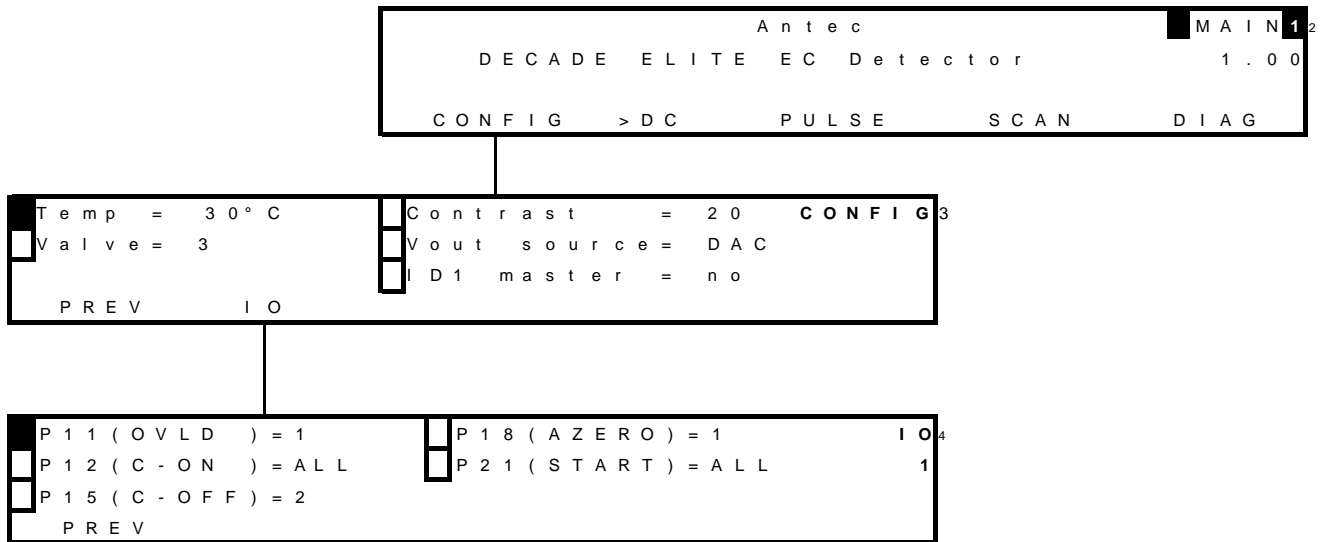

DIAG menu

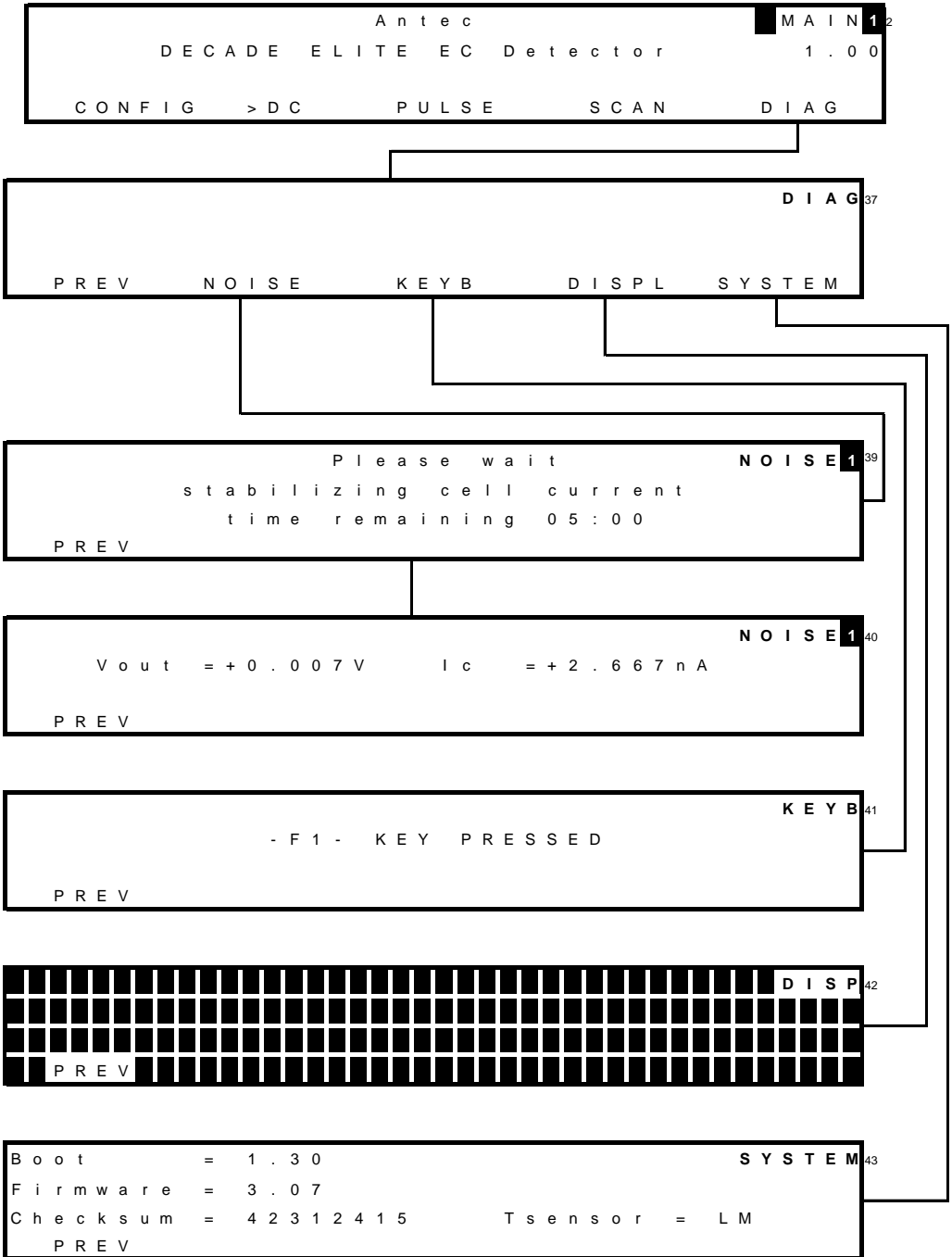

Parameters

Explanation: Type S is status, F is function and C is control.

Parameter	Screen	Description	Type
28 > 30°C	dc stat pulse stat scan stat run	Displays the actual (left value) and the pre-set oven temperature (right value).	S
AZERO	dc stat, run, pulse stat, scan stat	Sets the output voltage to 0 V, or to the offset voltage. Control Comp = off changes to Comp = on. If cell current exceeds the max. compensation a message "cell current exceeds max. compensation" appears. In that case max. compensation will be applied, which may not be the 0 Volt level but higher.	F
Boot	system	Displays boot firmware version	S
CELL=ON/ OFF	dc stat, pulse stat, scan setup, scan stat	Toggles between cell 'ON' and 'OFF'. Confirmation is required "Switch cell on (off)?" Switching on resets the clock to 0.00. Pulse mode: pulsation occurs as long as the cell is on, irrespective which screen is selected. Scan mode: potential E1 is applied.	F
Checksum	system	Displays checksum	S
Comp	dc stat, pulse stat	Toggles between 'ON' and 'OFF', releases auto zero offset. Switches ON if AZERO is pressed. Affects auto zero compensation only, not the % offset!	C
CONFIG	main	Enters config screen	F
Contrast	config	Sets the contrast of display	C
Cyc	scan setup	Controls the nature of the cycle: half, full and continuous. 'Half' means that the cell potential runs from E1 to E2 and stops at E2 (/). 'Full' means that the cell potential runs from E1 to E2, and back to E1, and then stops (Λ). 'Cont'	C

Parameter	Screen	Description	Type
		means that the cell potential runs from E1 to E2 and back to E1 continuously (ΛΛΛ.....). Pressing "STOP" or finishing the cycle, sets the potential to E1.	
DIAG	main	Enters Diag screen	F
DISPL	test	Enters DISP screen for display test.	F
E1, E2, E3, E4, E5	pulse setup2 pulse setup3	Controls the cell potential settings of the pulse. Can be set between +2.50 and -2.50 V with 10 mV steps. Can only be set or changed after confirmation with the 'enter' button.	C
Ec	prog (dc only), events setup (dc only), dc setup	Controls the cell potential, can be set between +2.50 and -2.50 V with 10 mV steps. Can only be set or changed after confirmation with the 'enter' button.	C
Ec	run (dc only), scan stat (dur- ing scanning)	Reflects the set cell potential. Displays the actual cell potential in the scan mode.	S
Events	dc setup, pulse set- upup2	Enter events menu	F
Filt (DC mode)	dc setup, dc stat, prog	Filter settings: RAW (100 Hz), Off (10 Hz) and 1 Hz to 0.001 Hz cut off frequency, in 1, 2, 5 steps.	C
Filt (PULSE mode)	pulse setup, pulse stat, prog	Filter settings: Off and 0.5 Hz to 0.001 Hz cut off frequency, in 1, 2, 5 steps. (Fcut-off / filter coefficients based on 1 Hz input frequency in pulse mode)	C
Filt	run	Reflects the actual filter setting.	S
Firmware	system	Displays firmware version	S
Hold resume	run, scan stat	Toggle, holds or resumes execution of scan.	F
HOLD=0,1	run, scan stat	Holds or continues execution of scan. Toggles between 1 and 0. Pressing hold again continues scan were it has been hold.	F

Parameter	Screen	Description	Type
Ic	stat (dc, pulse, scan), events setup, run, noise	Displays the true, non-compensated cell current, unaffected by auto zero or offset.	S
ID1 master	config	Sets sensor board 1 as master. When this setting is set to 'yes' all parameter settings from sensor board 1 are automatically copied/transferred to all other sensor boards present.	C
IO	Config	Enter IO menu	F
INJ=I/L	dc stat, pulse stat	Displays or switches the position of the injection valve, toggles between inject (I) and load (L). If a manual injector with position sensor is applied, it echoes the position of the injector. If an electrically actuated injector is used (optional) it is possible to switch the injector with this function button.	F/S
KEYB	test	Enters 'KEYB' screen, for keyboard test. Press 2x F1 to leave.	F
MARK	dc stat, pulse stat	Triggers a marker signal on output.	F
MaxComp	dc setup, pulse setup1	Maximum cell current that can be compensated for using auto zero.	S
Next	several screens	Enter next screen	F
NOISE	test	Enters NOISE screen for performance test.	F
Offs	dc setup, dc stat, prog, pulse setup1, pulse stat, scan setup, scan stat	Percentage offset, can be set between -50 and +50%.	C
POLAR	dc setup, pulse setup2	Inverts output polarity, toggle between + and -. Requires confirmation.	F
PREV	several screens	Return to previous screen	F

Parameter	Screen	Description	Type
P11(OVLD)	IO	Programmable output: can be configured that the overload (OVLD) signal of cell 1, 2 or 3 only is present on pin 11 when active or ALL cells.	C
P12(C-ON)	IO	Programmable input: can be configured that only cell 1, 2 or 3 is switched ON when active, or ALL cells.	C
P15(C-OFF)	IO	Programmable input: can be configured that only cell 1, 2 or 3 is switched OFF when active, or ALL cells.	C
P18(AZERO)	IO	Programmable input: can be configured that the signal of cell 1, 2 or 3 is zeroed when active, or ALL cells.	C
P21(START)	IO	Programmable input: can be configured that the data-acquisition on sensor board 1, 2 or 3 is started when active, or on ALL sensor boards.	C
Range	dc setup, dc stat, prog, pulse setup1, pulse stat, scan setup, scan stat	Range setting, varying from 10 pA to 200 μ A full scale, in 1, 2 and 5 steps. In the pulse and scan mode 10 nA to 200 μ A full scale can be used.	C
S	scan setup	Scan speed, can be set from 1 - 100 mV/s in 1, 2, 5 steps.	C
SPD	scan stat	Scan speed, can be set from 1 - 100 mV/s in 1, 2, 5 steps.	C
START	run, scan stat	In DC and pulse mode: toggle between STOP and START execution of a time file. Starts a scan in scan mode.	F
STOP	run, scan stat	Scan mode: STOP aborts scan and resets cell potential to E1. DC and pulse mode: toggle between STOP and START to control execution of a time file. Pressing 'STOP' aborts this run, cycle	F

Parameter	Screen	Description	Type
		counter (Cy) is reset to 1. STOP also deactivates the outputs Aux 1 and 2, and Relays 1 and 2 (status: 0000) and sets the electric valve to load (if present).	
SYSTEM	diag	Enter SYSTEM menu	F
t	pulse setup2, pulse stat	Displays the total duration of one pulse (t1 + t2 + t3 + t4 + t5).	S
t1, t2, t3, t4, t5	pulse setup2 pulse setup3	Duration of potential step E1, E2, E3, E4 and E5. Time can be set between 0 (t2 – t5) or 100 (t1) and 2000 ms in 10 ms increments. Maximum pulse duration is 9999 ms.	C
Temp	config	Controls the temperature of the oven. Range: off, 15 - 60°C, selectable in 1°C steps. The oven is stable from 7°C above ambient oven temperature.	C
Toven	dc setup, pulse setup1	Controls the temperature of the oven. Range: off, 15 - 60°C, selectable in 1°C steps. The oven is stable from 7 °C above ambient.	C
ts	pulse setup2	Controls the duration of the sampling time in the pulse mode. The time can be set between 20 ms and maximum t1-60ms with 20 ms increments.	C
Tsensor	system	Displays active temperature sensor	S
Valve	config	User confirmation whether a manual valve is connected to phone jack C on rear panel. If present: INJ=I or INJ=L appears in DC/Pulse Status screen	S
Vout	stat (dc, pulse, scan), events setup, run, noise	Displays output signal.	S
Vout source	config	Sets the output source from the analog data output: DAC (processed digital signal after 16-bit	S

Parameter	Screen	Description	Type
		AD conversion) or I/E (true analog signal from the I/E converter)	

Time file commands

Parameter	Screen	Description	Type
ADD	prog	Adds the active data line to the time file. Confirmation is asked for if an existing time is overwritten. As time 0.00 always exists, changing this time results in an overwrite warning.	F
Azero	prog	Controls auto zero, which can be programmed in a time file. Toggles between 'set' and 'not'.	
Cyc	run	Displays the cycle counter. If a time file has to be executed more than once ('Cycles'>1), this is the number of times a time file has been started. RESET (external) or QUIT sets Cy to 1 and returns to EVENTS SETUP screen.	S
Cycles	events setup	Controls the number of times a time file has to be repeated. This number can be 1 - 999 or continuous.	C
DEL	prog	Deletes the current data line from the time file. Deleting time 00.00, results in deleting the complete time file. Confirmation is required.	F
DEL	prog	Deletes the current data line from the time file. Deleting time 00.00, results in deleting the complete time file. Confirmation is required.	F
EVENTS	dc setup, pulse setup2	Enters EVENTS ('EVENTS SETUP' screen) for editing and running a time file.	F
EndCycle	prog	Enters a screen to set EndCycleTime. Controls duration of a time file (max. 999.99 min). When this time is reached the execution of the time file stops. If	F

Parameter	Screen	Description	Type
		programmed, the next run is started. Cannot be smaller than smallest time in time file +0.01 min. Is therefore never smaller than 0.01 min.	
File	events setup	Selected time file number. In the DC mode file numbers 1 - 5 are available, in the pulse mode file numbers 6 - 9 can be selected. The time files remain stored in RAM, also after switching off the DECADE Elite. Time files can be uploaded via LAN.	C
Hold resume	run, scan stat	Toggle, holds or resumes execution of time file or scan.	F
HOLD=0,1	run, scan stat	Holds or continues execution of time file or scan. Toggles between 1 and 0. Pressing hold again continues time file or scan were it has been hold.	F
Id	prog	Board identifier for multi cell purpose. Indicates for which boards time file settings apply. Binary coded.	C
Offs	run	Displays percentage offset during execution of a time file.	S
Outp	prog	Control of four output functions in EVENTS. Is open/high if '0', is closed/low if '1'. AUX1: 0001, AUX2: 0010, relay 1: 0100, relay 2: 1000. Combinations are possible.	C
QUIT	run	Aborts the time file and returns to the 'EVENTS SETUP' screen. The cycle counter ('Cy') is reset to 1. Outputs Aux 1 and 2, and Relays 1 and 2 are reset (status: 0000).	F
RUN	events setup	Enters RUN screen. System waits ("waiting") for the 'START' input trigger (external or keyboard) to start a run.	F

Parameter	Screen	Description	Type
SCROLL	prog	Scrolls through a time file.	F
Temp	events setup	Controls the temperature of the oven, is stored with time file. Temperature of active time file temperature overrides other temperature setting after selecting START.	C
Time	prog	Controls the time to execute a data line in a time file, can be set with 0.01 min resolution. Maximum time is 999.99 min. The time to stop the execution of a time file must be programmed by EndCycleTime.	C
Valve	prog	Controls the electrically actuated injector, during execution of a time file. Forces this valve to load ('LD') or inject ('INJ').	C

Clarity DECADE Elite control module

Full control and data acquisition of the DC and Pulse measurement mode is supported in the Clarity chromatography software.

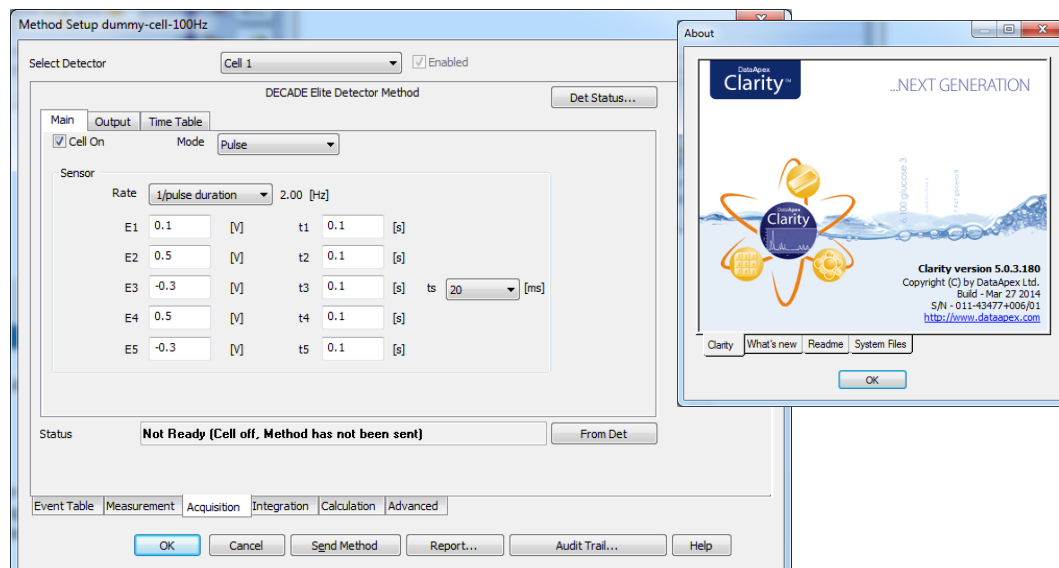

Fig. 8. DECADE Elite method window in Clarity. On the main tab the main measurement conditions can be set/controlled (measurement mode & potential settings).

Within a Clarity method it is possible to execute timed event by programming time lines under the Time table tab. Running a Time table enables time-based, automated parametric control of the electrochemical detection (ECD) during a run. This is particularly useful when during a run settings have to be changed such as the sensitivity, auto zero or control of external equipment.



The SCAN mode is not supported in Clarity. Scanning Voltammetry is supported in the Elite Dialogue software.

CHAPTER 5

Detection and Parameters

Introduction

One of the characteristics of electrochemical detection is its tremendous dynamic range. In amperometric detection peak heights may vary from micro-amperes down to the pico-ampere range. The DECADE Elite covers such a wide range from 200 μA down to 10 pA full scale, without being limited by electronic noise. For this reason the DECADE Elite is equipped with a 24-bit ADC and 16-bit DAC for analogue data output. One of the key features is that data can be sampled with data collection rates up to 100 Hz (100 pts/sec) in DC mode which assures that fast peak responses typical for UHPLC can be detected with sufficient resolution.

Three-electrode configuration

The circuitry of the DECADE Elite detector is designed for operation with electrochemical flow cells with a three-electrode configuration (Fig. 9). The working potential is set between the working electrode (WE) and the auxiliary electrode (AUX). The AUX is kept at a precisely defined reference electrode (REF) potential by means of the so-called voltage clamp. This is an electronic feedback circuit that compensates for polarization effects at the electrodes.

At the WE, which is kept at virtual ground, the electrochemical reaction takes place, i.e. electrons are transferred at the WE. This results in an electrical current to the I/E converter, which is a special type of operational amplifier. The output voltage of the I/E converter is digitized in the instrument by means of a 24-bit A/D converter and processed, and the resulting output current I_c can be acquired digitally by PC control software (Elite Dialogue or Clarity) or analog using the 'Analog Data output' on the rear

panel connected to a recorder or an external A/D converter.

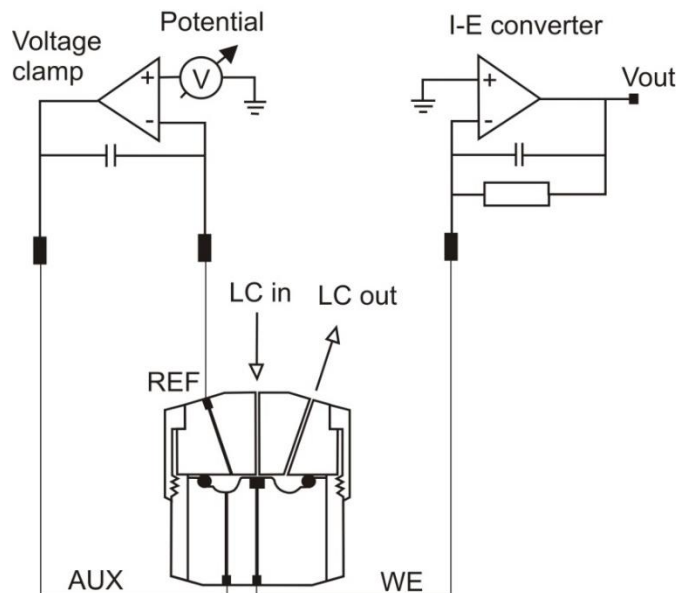

Fig. 9. Schematic representation of an electrochemical cell with a three-electrode configuration.

Essentially, for the oxidation or reduction reaction it would be sufficient to use only two electrodes. However, the three-electrode configuration has several advantages over a two-electrode configuration. If the working potential would be applied only over an AUX versus the WE (without REF), the working potential would continuously change due to polarization effects at the electrodes, resulting in highly unstable working conditions.

If the working potential would be applied only over the REF versus the WE (without AUX), the working potential would be very well defined. However, the potential of a REF is only well defined if the current drawn is extremely low (pico-amperes) resulting in a very limited dynamic range.

A three-electrode configuration, combines the best of both electrodes. The REF stabilizes the working potential and the AUX can supply high currents. This results in the tremendous dynamic range of a three-electrode system.

Internal organization

At the working electrode (WE) in the electrochemical flow cell the electron transfer takes place due to an oxidation or reduction reaction. The resulting electrical current is amplified by the current-potential (I/E) converter (Fig. 10).

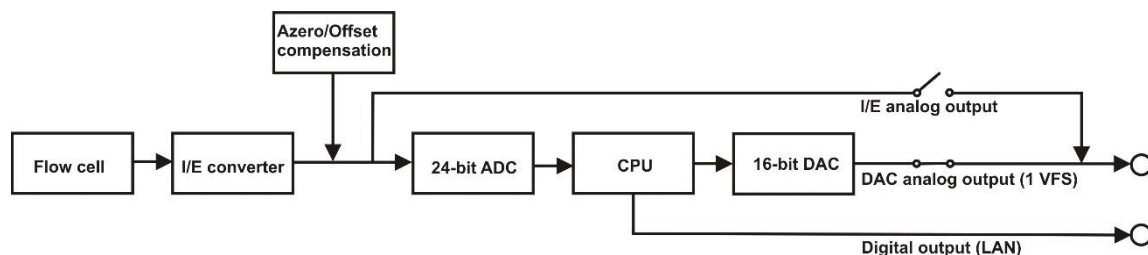

Fig. 10. DECADE Elite signal processing from electrochemical flow cell to output.

The signal from the I/E converter can be compensated with auto zero or offset, and is digitized using a 24-bits ADC. In the CPU the signal is processed, for example noise filtering, or more complex data processing in PAD. Finally after the 16-bits DAC the signal is set to a 1 V full scale analog data output (by default Output=ADC). Also the true analog signal from the I/E converter (before AD conversion) is available via the 'Analog data output' connector. This output can be selected in the CONFIG menu by setting the parameter Output=I/E.

Dual flow cell control

The DECADE Elite electronics are located on 2 different PCB's (printed circuit boards). The *control* board and the *sensor* board. The control board is dedicated to communication with PC (LAN) and keyboard & display. It has a processor with a so called 'event handler' that takes care of all user commands and hardware interrupts. The sensor board is fully dedicated to data acquisition and flow cell control. By using this architecture it is possible to extend the functionality of the DECADE Elite to more than one flow cell by simply adding a sensor board. The control board and other hardware is prepared for more than one sensor board. Typically, a two flow cell configuration can be used in serial or parallel mode detection.

Serial mode detection

In serial mode one LC system is used, with 2 flow cells in series. For data acquisition 2 data channels are applied with the same time base. Serial mode detection is especially suitable for OX-RED or RED-OX applications, examples are analysis of vitamin K and nitro-tyrosine, using micro HPLC. The first flow cell is a FlexCell that converts the analyte of interest in a detectable substance. The second flow cell is a SenCell or VT-03 cell which is used for detection. Note that it is necessary to work with *micro* HPLC because the conversion rate of the reactor cell is too small when using standard HPLC.

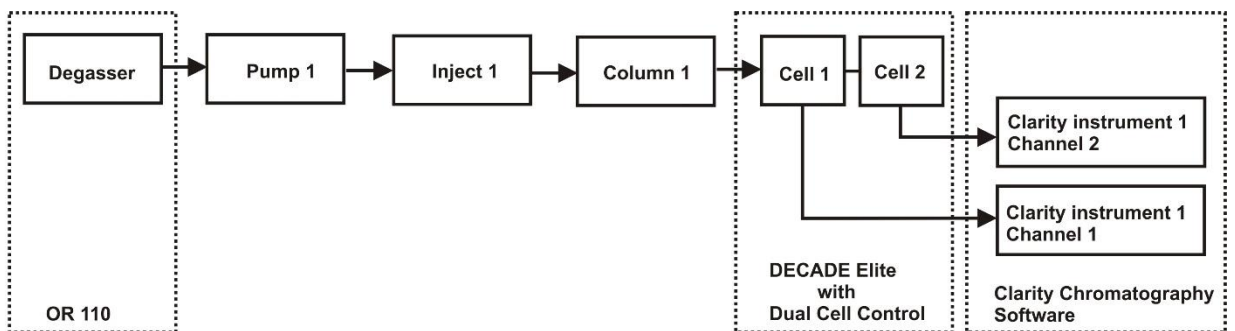

Fig. 11. Typical configuration for serial mode detection. Cell 1 is a FlexCell, cell 2 is a SenCell for detection. Channel 1 and 2 use the same time base of system 1.

Parallel mode detection

In parallel mode 2 HPLC systems are used with 2 flow cells. In fact, the DECADE Elite is operated as if 2 independent detectors are in one housing.

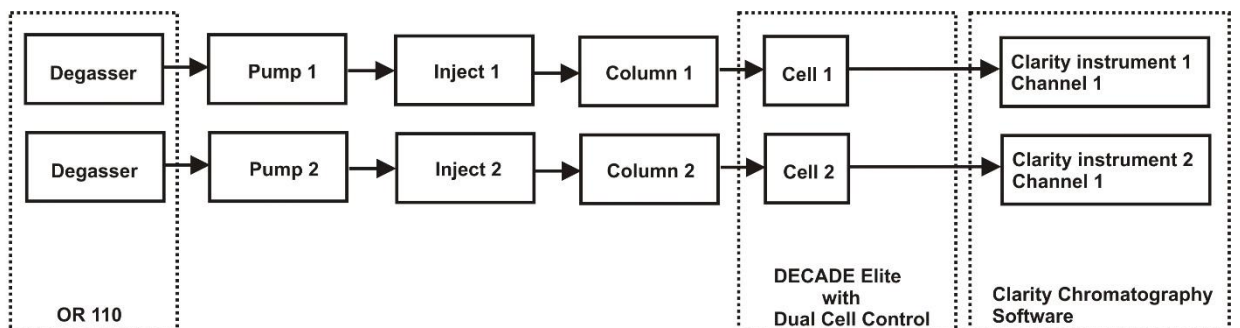

Fig. 12. Typical configuration for parallel mode detection. Two independent HPLC systems with dual channel support from OR 110, DECADE Elite and Clarity software.



Fig. 13. DECADE Elite with 2 columns and 2 SenCell flow cells for parallel detection.

Navigation in dual cell menu

All menus for a dual flow cell system are similar to a single cell system with 2 exceptions. First, in the top right corner a number is visible which indicates the active cell in display. Toggle with the “+” and “-” buttons between

sensor boards. If the board number does not change it means that the second sensor board is not installed or not properly recognized. Second, a new status screen is available in dual cell systems which indicates the status of both cells in a single screen. However, for convenience it is advisable to use PC control from the Clarity Chromatography software when working with 2 flow cells.

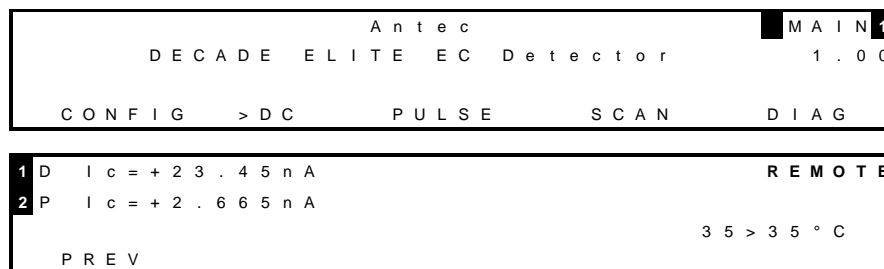

Fig. 14. DECADE Elite main menu (top) with active cell indicator in top right corner. Multi-STAT screen showing cell 1 (DC mode) and cell 2 (PULSE mode).

Parameters

Operational parameters are controlled from the SETUP screens in the DECADE II. Parameters are filter, cell potential and offset. Temperature is set in CONFIG menu.

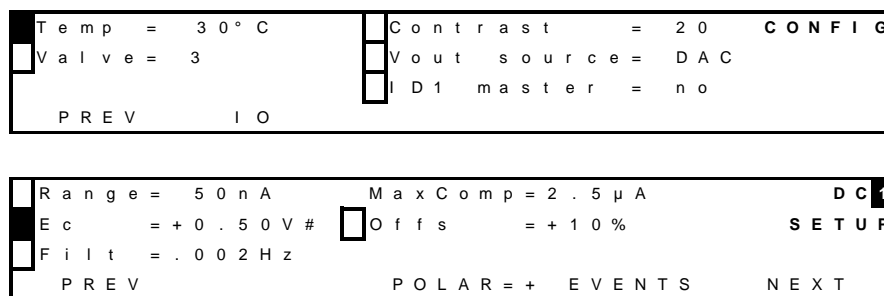

Fig. 15. Selection of parameters in the 'DC SETUP' screen. Temperature is set in CONFIG menu.

Range

Range selection is done in the 'SETUP' or 'STAT' screen in DC, PULSE and SCAN mode. A number of ranges can be selected; the maximum current that can be compensated for using auto zero and offset differs. The high sensitivity ranges (10 pA - 5 nA) have the best noise specifications. In fact, there is a trade-off between best noise specification at sensitive

ranges, and maximum compensation at the less sensitive ranges. This is an inevitable consequence of the tremendous dynamic range that is covered by electrochemical detection.

Table II. DC ranges and maximum compensation.

Range	FS	Max comp	Range	FS	Max comp
200	μA	2.5 mA	20	nA	2.5 μA
100	μA	2.5 mA	10	nA	2.5 μA
50	μA	2.5 mA	5	nA	250 nA
20	μA	2.5 mA	2	nA	250 nA
10	μA	2.5 mA	1	nA	250 nA
5	μA	2.5 mA	500	pA	250 nA
2	μA	25 μA	200	pA	250 nA
1	μA	25 μA	100	pA	25 nA
500	nA	25 μA	50	pA	25 nA
200	nA	25 μA	20	pA	25 nA
100	nA	25 μA	10	pA	25 nA
50	nA	2.5 μA			

In the PULSE and SCAN mode, current is much higher than in DC mode. Therefore it is not possible to select pA ranges.

Table III. PAD ranges and maximum compensation.

Range	FS	Max comp	Range	FS	Max comp
200	μA	2.5 mA	500	nA	25 μA
100	μA	2.5 mA	200	nA	25 μA
50	μA	2.5 mA	100	nA	25 μA
20	μA	2.5 mA	50	nA	2.5 μA
10	μA	2.5 mA	20	nA	2.5 μA
5	μA	2.5 mA	10	nA	2.5 μA
2	μA	25 μA			
1	μA	25 μA			

Offset

A maximum offset of +50% and - 50% in 5% steps can be set. For example, 20% is a 200 mV offset when the maximum output is 1.0 Volt.

Polarity

The polarity of the output can be inverted. Oxidative and reductive analyses generate opposite currents. For data acquisition, traditionally chromatographic peaks have a positive amplitude. Therefore selection of polarity is useful.

Filter

High frequency noise is efficiently removed and chromatographic peaks can be detected with better signal to noise ratio.

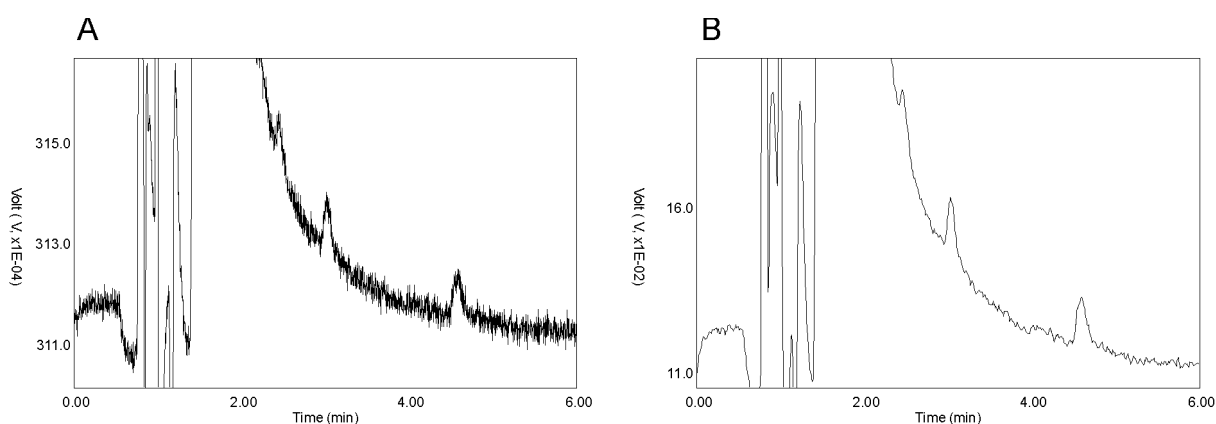

Fig. 16. Signal to noise ratio is improved using a filter (A vs. B).

The DECADE Elite is equipped with ADF (Advanced Digital Filter) as a tool to filter the acquired signal and improve the sensitivity of the analysis (Signal-to-noise ratio). In the next chapter the filter setting is explained including detailed background information about filtering.

DC mode

In the tables below the available filter settings for the DC mode are listed with the corresponding data rate of the output. Data rate is expressed as number of data points per second (Hz). In the DC mode the data rate is not an adjustable parameter but is coupled to the filter setting, except for RAW. RAW is special, the incoming data are not filtered and a data rate between 1 and 100 Hz can be selected.

Table IV. DC mode filter setting and corresponding data rate.

Filter setting DC mode (Hz)	Data rate (Hz)
RAW	100(default), 50, 20, 10, 5, 2, 1
10	100
5	50
2, 1	20
OFF	10
0.5, 0.2, 0.1	10
0.05	5
0.02	2
0.01, 0.005, 0.002, 0.001	1

Filter OFF is also a special case. The data rate is fixed to 10 Hz, and the data is not filtered. Setting OFF is therefore the same as RAW at 10 Hz.

Pulse mode

In the pulse mode the working electrode is dynamically and continuously regenerated by a series of potential steps in a cyclic manner. Data is processed differently, and the data rate is defined by the total duration of the 5 potential steps in a pulse: $t_1 + t_2 + t_3 + t_4 + t_5$. Usually the duration is between 0.5 and 2s (data rate between 2 – 0.5 Hz). Filter settings in the pulse mode are therefore between 0.5 and 0.001 Hz, and OFF.

Scan mode has no filter at all.

CHAPTER 6

Noise suppression: ADF™

Introduction

Besides for its tremendous linear dynamic range and selectivity, electrochemical detection is well-known for its very low limits of detection. To further improve these detection limits the Antec engineers have developed ADF (Advanced Digital Filter) and the DECADE Elite has been equipped with it as a standard. The improvement factor in signal-to-noise (S/N) ratio depends on the frequency relation of signal and baseline noise. S/N improvements from a factor 5 up to more than 100 have been obtained. To understand how a digital filter works, first the importance of frequencies in chromatographic analysis will be explained. Then we will look at peak width, filter settings, cut off frequency, amplitude response plots and finally at a few chromatograms before and after applying ADF.

Frequency

A scientific definition of frequency is “the number of completed alterations per unit time”. It has two dimensions: count and time. Frequency is usually expressed in Hz, which is counts per second.

The counts themselves can run in a regular, evenly spaced manner, as with sine waves whose curve shapes do not change. Alternatively, the counts can run in an irregular manner within the specified unit of time. If the latter happens, frequencies would vary if broken down into smaller units of time.

In the example of *Fig. 17* a signal is shown with a frequency of 12 alterations in 5 minutes. To express its frequency in a more scientific way a full period is precisely determined and expressed in Hertz (or s^{-1}). It is a sine wave with a frequency of 0.04 Hz (*Fig. 18*).

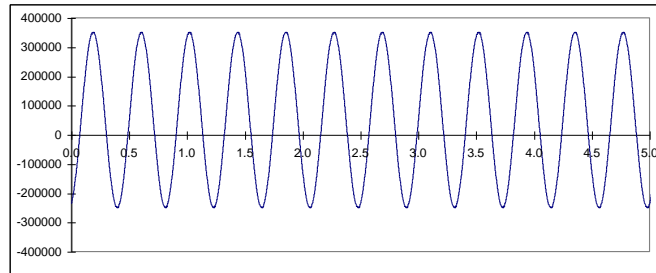

Fig. 17. Example of a signal with regular evenly spaced alterations: a sine.

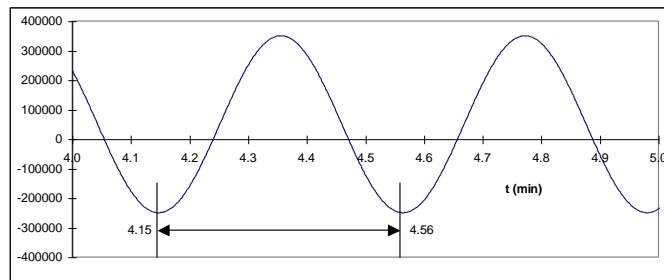

Fig. 18. Sine of Fig. 17. A full period is 0.41 min (25 s) which corresponds to a frequency of $1/25 = 0.04$ Hz.

Frequency of signal and noise

Also a chromatographic peak can be expressed in terms of frequencies. The way to determine this frequency is the same. The duration of the full peak is measured and expressed in Hz.

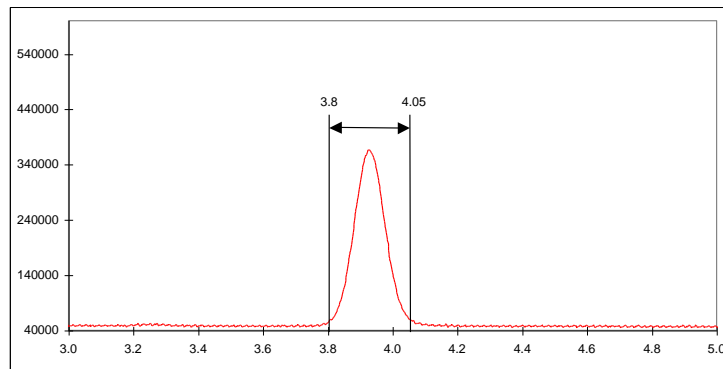

Fig. 19. Frequency tells how often something happens: 1 peak in about 0.25 min (15 s), $f = 1/15 = 0.07$ Hz.

This is further illustrated by an overlay of the same chromatographic peak with a sine of 0.07 Hz (Fig. 20).

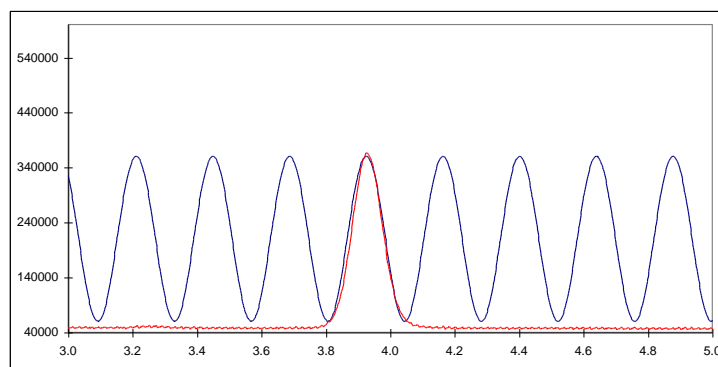

Fig. 20. Overlay of a chromatographic peak with 0.07 Hz sine.

Typically in chromatography narrow peaks are in front of a chromatogram while peaks with longer retention times get wider. As a consequence frequencies are not constant but vary between 0.1 – 0.01 Hz, which corresponds to 10 – 100 s peak width.

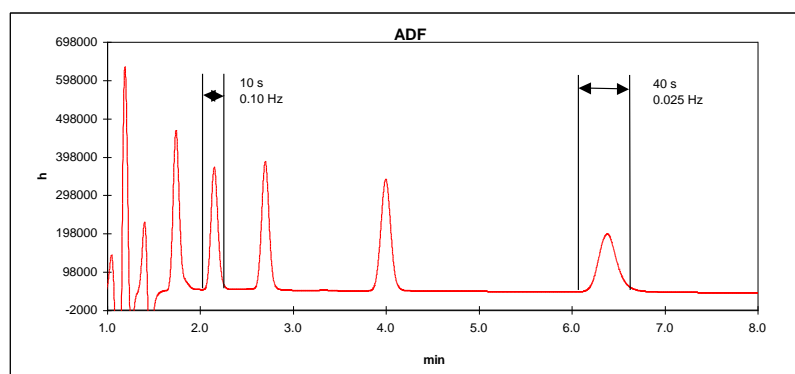

Fig. 21. Typical chromatogram with peak widths between 10 – 100 s.

Noise in chromatography can come from different sources. Pump pulsations are typically shown as a very regular noise pattern, while electronic

noise has a more random character. This is illustrated in *Fig. 22* where a noise trace is shown with an overlay of a 10 and 0.4 Hz sine.

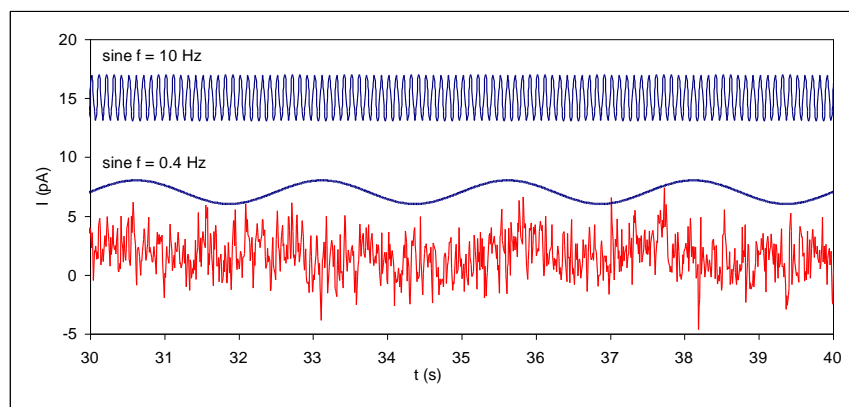

Fig. 22. Typical random noise in chromatography (lower trace). Both frequencies (0.4 and 10 Hz) can be recognised amongst others.

Looking closely to the lower noise trace both frequencies (and others) can be recognised. This is typical for noise in chromatography: a collection of more or less random frequencies.

Low pass noise filters

The way noise filters work is by suppressing certain frequencies in the acquired signal. Typically low pass filters allow chromatographic peaks (low frequency) to pass, while high(er) frequency noise is attenuated. No matter how advanced, it is impossible to use a low pass filter successfully if there is no difference in frequency of signal and noise.

Analogue filters are made of hardware, from capacitors, resistors and amplifiers (opamps). Digital filters are mathematical routines to process an acquired signal.

Traditionally, in many detectors for chromatography an analogue low-pass filter is applied (rise time filter). A 'passive' RC filter consists of resistors and capacitors. An active higher order filter can be considered as a number of these RC filters in series. In a 4th order filter the signal coming from the first filter is filtered again in a second, third and fourth filter. During these steps, loss of signal occurs simply because of all the resistors that are applied. Operational amplifiers, which are 'active' components, are applied in each stage to restore the signal to its original value.

With the availability of powerful processors, digital signal processing has become an excellent alternative for hardware filters. In its most simple

form a running average filter takes the average of n data points to create a new data point. For example in a 5-points running average filter output data point $y[80]$ is calculated from measured data points $x[80] - x[84]$ as:

$$y[80] = \frac{x[80] + x[81] + x[82] + x[83] + x[84]}{5}$$

Each input data point has the same weighting factor of $1/5$. In more advanced digital signal processing a more complicated equation is used to calculate the output data point $y[n]$:

$$y[n] = a_0 x[n] + a_1 x[n-1] + a_2 x[n-2] + a_3 x[n-3] + \dots$$

In contrast to the previous equation, each data point has a different weighting factor a . Sum of these weighting factors $a_0 \dots a_n$ will always be 1. Characteristic of noise filters is that processing the signal will result in a delay. This is inevitable, as the mathematics of digital signal processing requires a number of previous data points to process a new data point. The filter characteristic in DSP is often named after the scientist who 'invented' the mathematics behind the signal processing routine. Well-known names in this field are Bessel, Chebychev, Savitsky, Golay, Hamming and many others.

Amplitude response plot

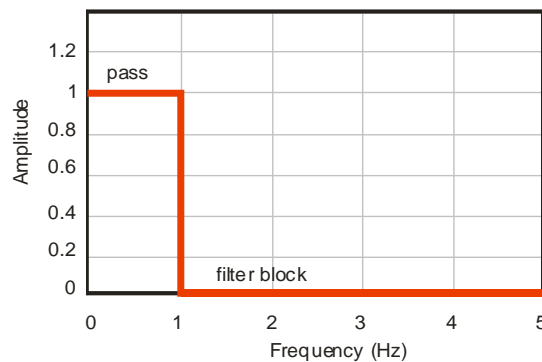

Fig. 23. Amplitude response plot of an ideal low pass filter with a cut-off frequency of 1 Hz.

There are several ways to describe the filter characteristics. An amplitude response plot gives important information on filter behavior. Suppose our signal of interest has a frequency between 0 - 1 Hz, and all higher frequencies are noise. An ideal filter is shown in *Fig. 23* where signal frequencies

between 0 – 1 Hz completely pass while frequencies of higher than 1 Hz are completely blocked.

In practice filters behave a bit different from the ideal situation. Amplitude response plot shows a more gradual attenuation profile at higher frequency. This cut off frequency is where the output signal amplitude is 70% of the input signal, also known as 3 dB point.

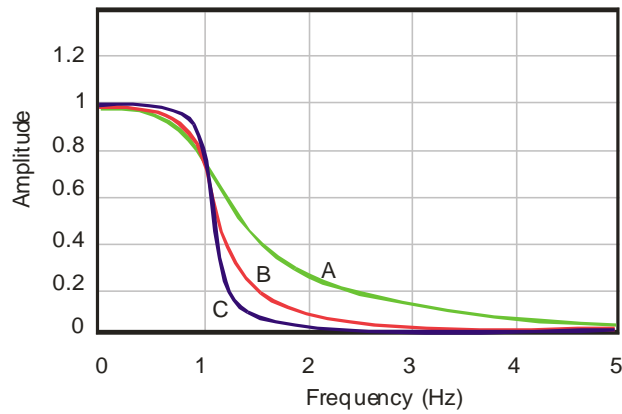

Fig. 24. An amplitude response plot of a low pass filter with a cut-off frequency of 1 Hz. It is a 2 (A), 4 (B) and 8 (C) pole Bessel filter.

In Fig. 24 it is shown that the number of poles is important, a filter behaves more ideal with increasing number of poles. In a hardware filter the number of poles is the number of filter circuits that are placed in series.

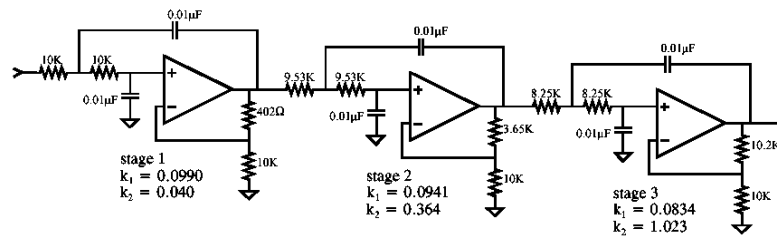

Fig. 25. Analogue 6 pole Bessel filter.

A digital filter does not have poles, but it is characterized by the number of input data points used to calculate a new output data point. For example a 9-point digital filter (Savitzky-Golay) is given as:

$$\begin{aligned} Y[1] = & -0.090909091 X[1] + 0.060606061 X[2] + \\ & 0.168831169 X[3] + 0.233766234 X[4] + \\ & 0.255411255 X[5] + 0.233766234 X[6] + \\ & 0.168831169 X[7] + 0.060606061 X[8] + \\ & -0.090909091 X[9] \end{aligned}$$

Note that the sum of coefficients is exactly 1. $Y[n]$ is the output data point, $X[n]$ are input data points. Generally spoken, the performance of a digital filter improves with more input data points, but also more processor capacity is required for the large number of calculations.

Applying ADF in chromatography

If noise frequencies in LC-EC differ from the frequency of the signal, noise can be suppressed. Using the right filter setting (cut-off frequency) will specifically attenuate noise and improve the signal-to-noise (S/N) ratio. No matter how 'advanced' a filter is, it is only possible to apply low pass filtering if noise frequencies are higher than the frequency of the signal.

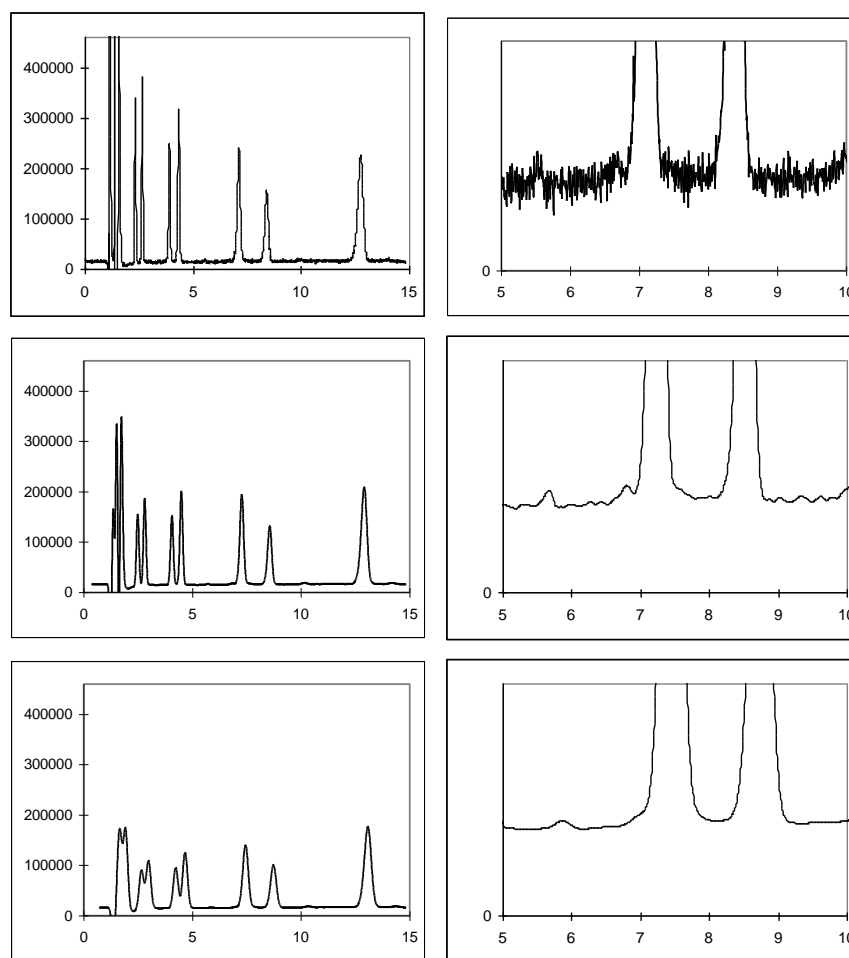

Fig. 26. From top to bottom filter setting of 0.5, 0.02 and 0.002 Hz. Narrow peaks in front of the chromatogram are deformed at 0.005 Hz, whereas wider peaks show hardly any deformation (see peak at $t \sim 13$ min). Attenuation of noise is shown in the close up on the right.

Prerequisite for a 'good' noise filter for data acquisition in liquid chromatography is that it improves the S/N ratio without significant distortion of the

signal of interest. This is particularly difficult if the frequency of the signal is close to the frequency of the noise.

The DECADE Elite has a number of filter settings to optimize for best possible signal-to-noise ratio. The width of the peaks of interest is important because wider peaks allow stronger filter settings simply because of the lower frequency of such peaks. Advised filter setting to start further optimization is given as:

$$\text{Filter setting} = 1 / [2 * (\text{peak width})]$$

So at a 10 s peak width a 0.05 Hz filter setting is advised. If peaks are 50 s a 0.01 Hz filter is advised to start with. Note that if a chromatogram has interesting peaks of 10 s as well as 50 s, it may not be possible to work with one filter setting. In that case it is advisable to switch to a stronger filter setting for the second half of the chromatogram using a timed event. To optimize for the best S/N ratio, use the lowest acceptable cut-off frequency.

After optimization, do not change the cut-off frequency setting during analysis of a calibration sequence. Use the same settings for analysis of samples and calibration standards.

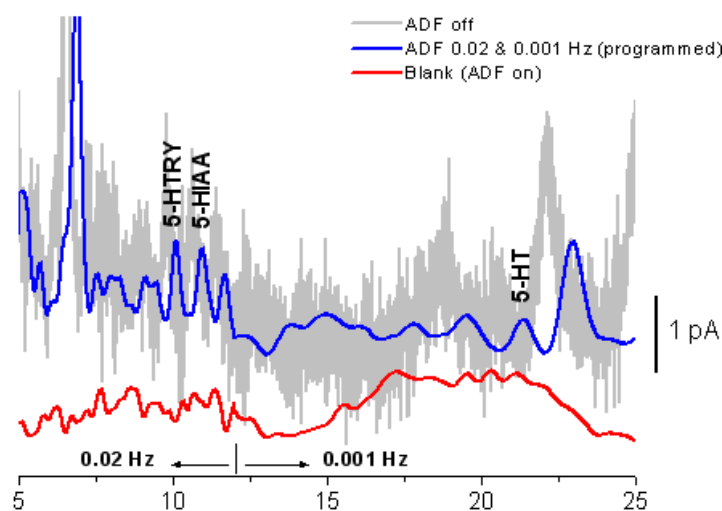

Fig. 27. Analysis of 20 pmol/L 5-hydroxytryptophan, 5-HIAA and 5-HT using ADF for improving detection limits.

The S/N improvement depends on the composition of the frequency spectrum. Improvement up to a factor 100 may be obtained compared to an unfiltered signal. As high frequency noise is suppressed, remaining noise

components will be in the same frequency range as chromatographic peaks.

As suppressing noise will always result in (some) suppression of signal it is advised to switch the DECADE Elite to the highest acceptable sensitivity.

CHAPTER 8

Pulsed Amperometric Detection (PAD)

Introduction

In pulsed amperometric detection (PAD) the working electrode (WE) is regenerated at a frequency of 0.5 - 3 Hz by the application of a series of potential changes. This is particularly useful for certain applications where the working electrode is rapidly fouled due to adsorption of insoluble reaction products. A well-known application area of PAD is the analysis of carbohydrates (Fig. 28) [1].

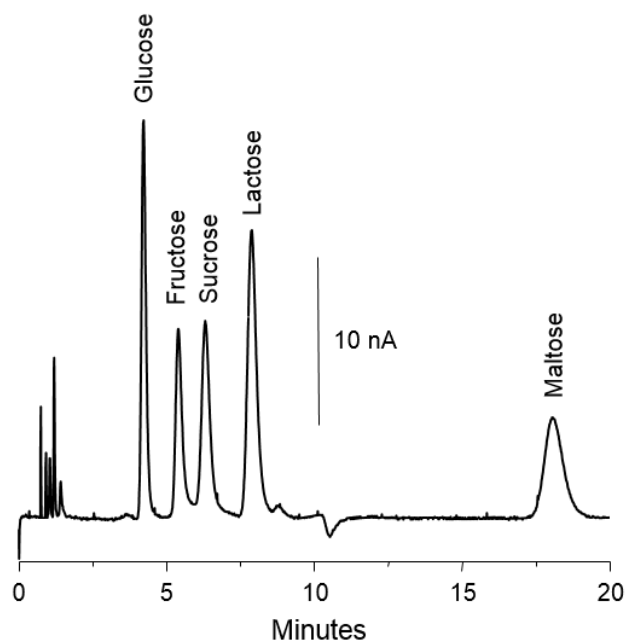

Fig. 28. Carbohydrate analysis in the pulse mode.

Pulse vs. DC mode

The pulse mode is quite different from the DC mode. Instead of a constant potential, a series of potential steps is applied in a cyclic manner. The signal is sampled during a fraction of the total pulse cycle. During the sampling time (t_s) the signal is collected and this value is sent to the detector output. The frequency of data output is determined by the pulse duration: $t_1 + t_2 + t_3 + t_4 + t_5$. Usually the duration is between 0.5 and 2s (data rate between 2 – 0.5 Hz).

The background or cell current is usually considerably higher (100 - 1000 nA) than in the DC mode. Therefore, only nano- and microampere ranges are available in the pulse mode. Typically, the background current is between 0.1 – 2 μ A.

When the frequency of the data acquisition system (integrator) is higher than the pulse frequency a typical stepwise pattern may appear in the chromatogram. This is called 'oversampling' and these steps are usually only visible after considerable magnification of the chromatogram. It is recommended to keep the data acquisition at 1 Hz.

High pH of mobile phase

In carbohydrate analysis another 'special' consideration has to be taken into account. Detection is done in the pulse mode using a flow cell with gold electrode. For separation an anion exchange column is used with a mobile phase of around 20-100 mmol/L sodium hydroxide. The pH is between 12 and 14. This puts some demands on the HPLC system, and flow cells.

After prolonged use of the flow cell with a gold working electrode (WE) in the pulse mode, the gold oxide which is generated at the WE, precipitates on the auxiliary electrode (AUX). This gold oxide coating may electrically isolate the AUX and result in an increase of the noise. Cleaning the AUX electrode with metal wool is a way to remove this coating.

The reference electrodes of the Ag/AgCl type are not suitable for carbohydrate analysis. Due to silver oxide formation they require regular (monthly) maintenance. HyREF reference electrodes are maintenance free under these conditions and are therefore particularly suited.

If a mobile phase is used with a high pH (pH>10, carbohydrate analysis), the standard Vespel rotors from the injection valve should be replaced by Tefzel rotors which are pH resistant.

For carbohydrate analysis, only CO₂-free sodium hydroxide should be used since carbonate anions may disturb the ion exchange chromatography. It forms CO₃²⁻ which is a strong modifier. The CO₂-free sodium hydroxide is available from several suppliers as a 50% solution

(19.2 mol/l). NaOH pellets are not recommended because of their high CO₂ content.

Organic modifiers (acetonitrile) strongly attenuate the signal of most carbohydrates in PAD and are therefore not recommended.

Pulse settings

In PAD of carbohydrates a series of potentials is applied in a continuous cyclic manner. During time interval t_1 the detection potential is applied. The data collection occurs within t_1 , during time interval t_s (sampling time). The time difference $t_1 - t_s$ is the stabilization time.

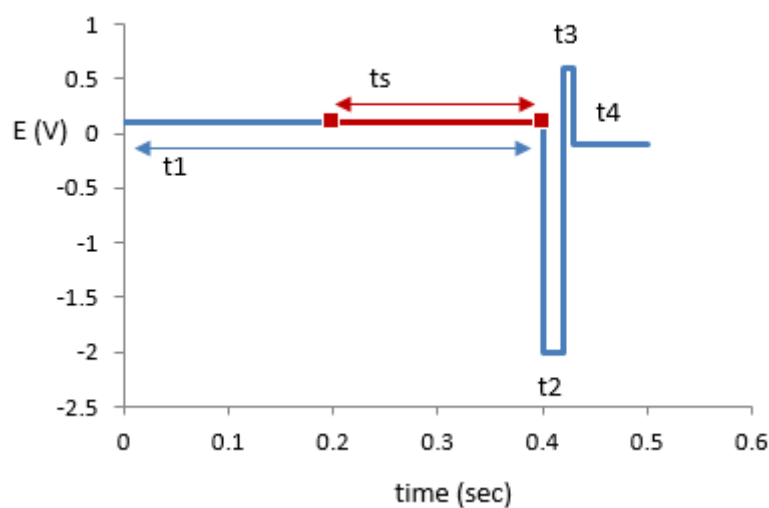

Fig. 29. Potential steps in pulsed amperometric detection. During t_1 the detection potential is applied, detection occurs during t_s . Steps t_2 , t_3 and t_4 are for regenerating the electrode. This process repeats itself continuously as soon as the cell is on.

During the next time intervals (t_2 .. t_4) the electrode is 'cleaned' by reductive and oxidative potential steps.

Optimization of wave forms

LaCourse and Johnson [2-4] have published several papers on optimization of wave forms in PAD. Several considerations are important for the choice of the pulse duration. Optimization is depending on the working electrode material, the sample constituents and the required detection frequency. The impression may arise that the number of variables, 5 potential

steps and 6 time settings, may lead to a time-consuming optimization procedure. In practice, the pulse mode is more straightforward and published in several excellent review papers and application notes.

Output frequency

An important difference between the DC and the pulse mode is the frequency of the output signal. In the DC mode the signal has a 1-100 Hz frequency, in the pulse mode the frequency is determined by the duration of the pulse. Once every cycle, the signal is sent to the output.

If a stepwise pattern in the chromatogram is seen when zooming in, it means that the data acquisition has an unnecessarily high sampling frequency. This leads to large data files, but certainly not to a better chromatogram. Usually, data acquisition at 1 Hz is sufficient.

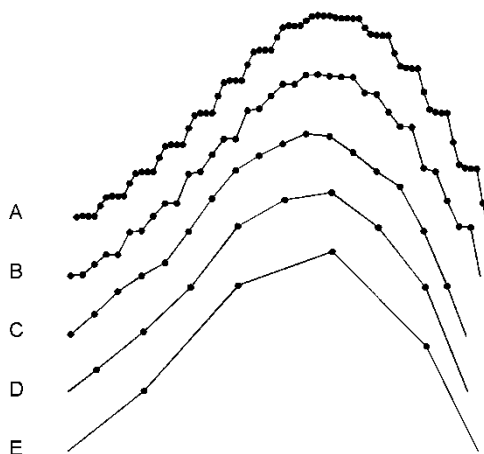

Fig. 30. A detailed part of a chromatogram acquired at different data frequencies. The data rate is (A) 5x, (B) 2.5x, (C) 1.2x, (D) 0.6x and (E) 0.3x the frequency of the pulse. C is 1 Hz data rate.

Working electrode material

Gold and platinum are used as working electrodes for PAD. Glassy carbon appears to be unsuitable due to the high electric capacitance of this material. Furthermore, resurfacing of the noble metal working electrode is

based on formation and removal of a (metal-) oxide layer. This is impossible with glassy carbon.

References

1. D.C. Johnson, D. Dobberpuhl, R. Roberts and P. Vandeberg, Review. Pulsed amperometric detection of carbohydrates, amines and sulphur species in ion chromatography - the current state of research, *J. Chromatogr.* 640 (1993) 79-96
2. D.C. Johnson en W.R. LaCourse, *LC with pulsed ECD at gold and platinum electrodes*, *Anal. Chem.*, 62 (1990) 589A-597A
3. W.R. LaCourse en D.C. Johnson, Optimization of waveforms for pulsed amperometric detection of carbohydrates following separation by LC, *Carbohydrate Research*, 215 (1991) 159-178
4. W.R. LaCourse en D.C. Johnson, Optimization of waveforms for pulsed amperometric detection of carbohydrates based on pulsed voltammetry, *Anal. Chem.* 65 (1993) 50-55

CHAPTER 9

Optimization of the working potential

Introduction

A current - voltage (I/E) relationship, or voltammogram, characterizes an analyte. It gives information on the optimum working potential, which can be used to improve detection sensitivity and selectivity.

There are several ways to obtain a voltammogram:

- A *hydrodynamic* voltammogram is obtained in the DC mode by running several chromatograms at different working potentials. Both peak height and background current are plotted against the working potential. A hydrodynamic voltammogram has as an advantage that the I/E relationship of all analytes of interest can be obtained simultaneously in one set of experiments (boundary condition: all analytes should be sufficiently separated under the applied LC conditions). Furthermore, under real chromatographic conditions reliable information about the S/N ratio is obtained.
- A *scanning* voltammogram is obtained in the so-called scan mode of the DECADE Elite: the voltage runs between two pre-set potential values (E_1 and E_2) and scan speed (in mV/s) and the current is measured.

Optimization of the working potential and the construction of a voltammogram is described.

Electrochemical reactions

In electrochemical detection (ECD) a reaction of the analyte at an electrode surface is monitored. This distinguishes ECD from most other detection techniques where detection is based on the physical properties of an analyte (i.e. mass spectrometry: molecular mass, absorbance detection: molar absorptivity). For electrochemically active compounds, the potential between reference electrode (REF) and working electrode (WE) determines the reactivity of the analyte at the WE. The potential difference sup-

plies the energy level needed to initiate or enhance the electrochemical reaction. Different analytes may have different oxidation or reduction potentials, which determines the selectivity of ECD.

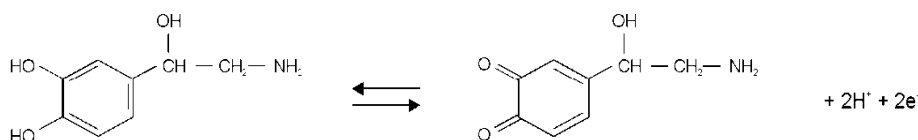

Fig. 31. Oxidation/reduction reaction of norepinephrine.

An example of an electrochemical reaction is shown in Fig. 31, norepinephrine is converted into a quinone by oxidation at the WE. Two electrons are transferred at the WE resulting in an electrical current that is amplified by the controller.

Hydrodynamic and scanning voltammogram

Hydrodynamic voltammogram

A hydrodynamic voltammogram is constructed when the pure analyte is not available and separation over an analytical column is required. Furthermore, under real chromatographic conditions reliable information about the S/N ratio is obtained. The peak heights obtained from the sequence of chromatograms are plotted against the working potential used. Also the background current (I_{cell}) is plotted.

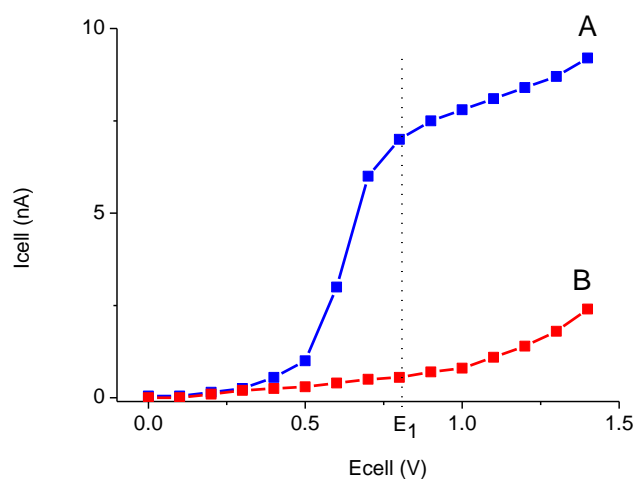

Fig. 32. Hydrodynamic voltammogram of norepinephrine (A) at a glassy carbon working electrode, and the current of the baseline (B). At E_1 the electrochemical signal becomes diffusion limited.

Scanning voltammogram

An alternative for the chromatographic construction of an I/E relationship is the application of scanning voltammetry. In a scanning voltammetry experiment the working electrode potential is ramped up and down between two preset potentials (E1 and E2) and the current is measured while the analyte is continuously flushed through the flow cell. This is repeated as many times as desired. The rate of voltage change over time is defined as the scan rate (V/s).

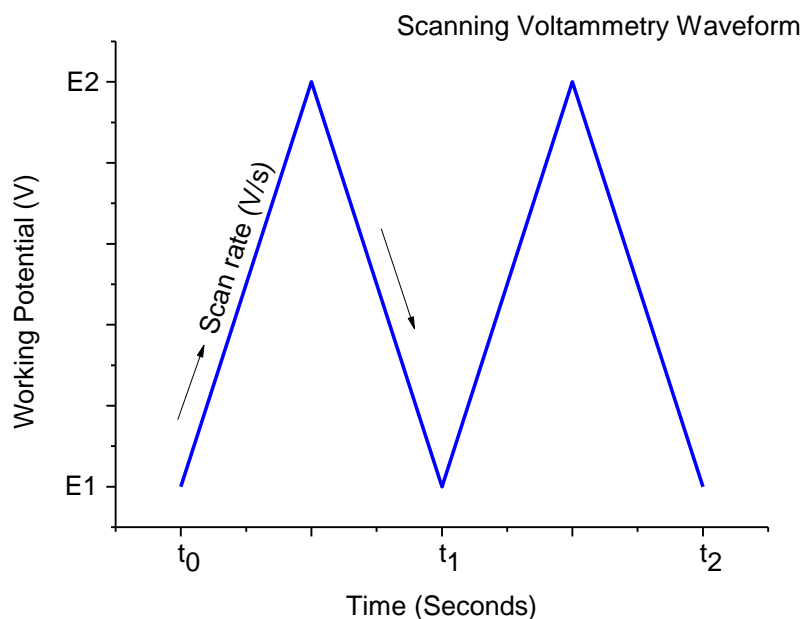

Fig. 33. Scanning voltammetry potential waveform.

The current is plotted against the working potential to give a voltammogram (I/E curve). An example is shown in Fig. 34. A difference with a hydrodynamic

In scanning voltammetry, no HPLC separation is involved. The signal is the sum of all EC active substances. It takes only a few minutes to construct a *scanning* voltammogram. This is an advantage, especially when a number of analytes have to be characterized. However, it is a prerequisite to have the *pure* analyte dissolved in buffer. A scan of the buffer (blank) should be used to distinguish between solvent peaks and analyte peaks.

Any contamination in the buffer may lead to artefacts.

As can be seen in both Fig. 32 and Fig. 34, when the working potential is increased the electrochemical reaction is enhanced hence the signal increases. At a certain potential the I/E curve flattens. All analyte molecules that reach the working electrode are converted at such a high rate that the analyte supply becomes the limiting factor. At the working electrode surface a stagnant double layer exists, where molecular transport takes place by diffusion only. Therefore, the current at (and beyond) this potential is called the *diffusion limited current*.

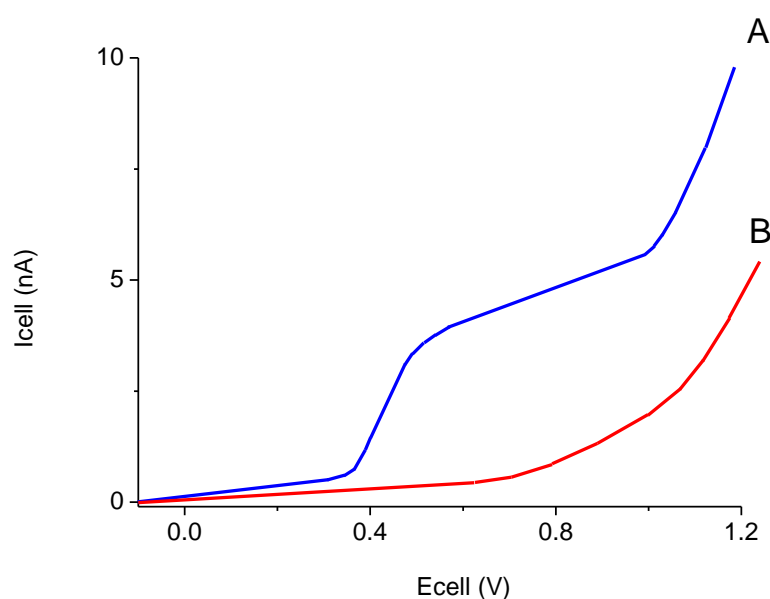

Fig. 34. Scanning voltammetry of $1.0 \mu\text{mol/l}$ norepinephrine (A) at a glassy carbon working electrode, at a scan speed of 10 mV/s . Scan (B) is the blank solvent.

With respect to *sensitivity*, a high working potential is important. However, at higher working potentials, more analytes are detectable. So, as to *selectivity*, a low working potential will be favorable.

Working at a potential on the slope of the I/E curve will result in less reproducibility in HPLC. A small fluctuation in the applied potential, or any change in the system (like for instance a pH change) may result in differences in measured peak height. In practice the choice of the working potential is a compromise between sensitivity, selectivity and reproducibility. In the example of Fig. 32 a working potential (E_1) of 0.8 V is chosen.

Optimization using a voltammogram

Sometimes, when interfering peaks appear in the chromatogram, it is possible to optimize the method with regard to selectivity. If the interfering compound has a higher oxidation potential, a working potential is chosen that gives the best selectivity, i.e. the largest difference in peak height. In the example of Fig. 35 the selectivity for compound X is improved considerably by decreasing the potential to E_2 or E_1 . Obviously, if compound Y is the compound of interest, optimization of selectivity in this way is not possible and the chromatography has to be optimized.

Electrochemical detection differs from most other LC detection methods in that a reaction takes place in the detection cell. Due to reaction kinetics an increased temperature speeds up the oxidation/reduction reaction. However, this not only holds for the analyte but also for the background current and possible interferences. An elevated temperature will therefore not automatically lead to a better detection. A *constant* temperature is of paramount importance for a stable baseline and reproducible detection conditions.

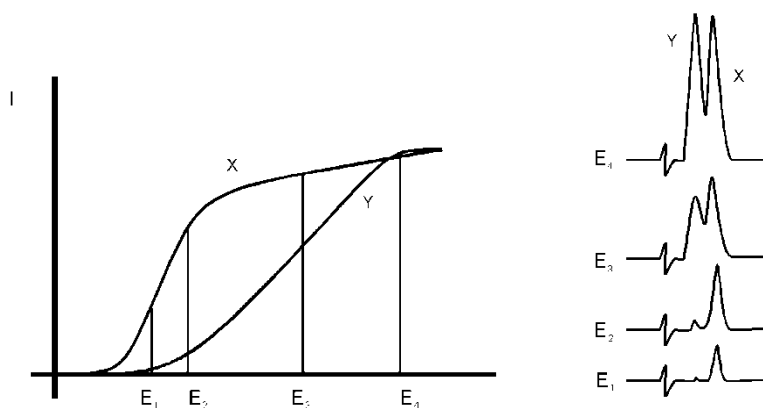

Fig. 35. Selectivity in LC-EC of compound X and Y is optimised by choosing the working potential with the largest difference in peak height.

Electrochemical reactions are pH sensitive (Fig. 36). For norepinephrine the I/E curve is shifted to a lower potential at higher pH. When the working potential is high (E_2), and the signal is diffusion limited, an increase in pH will result only in a small increase of the peak height. When the working potential is lower (E_1), and the signal is not diffusion limited, the signal will strongly increase at higher pH. In both cases the background current increases at a higher pH.

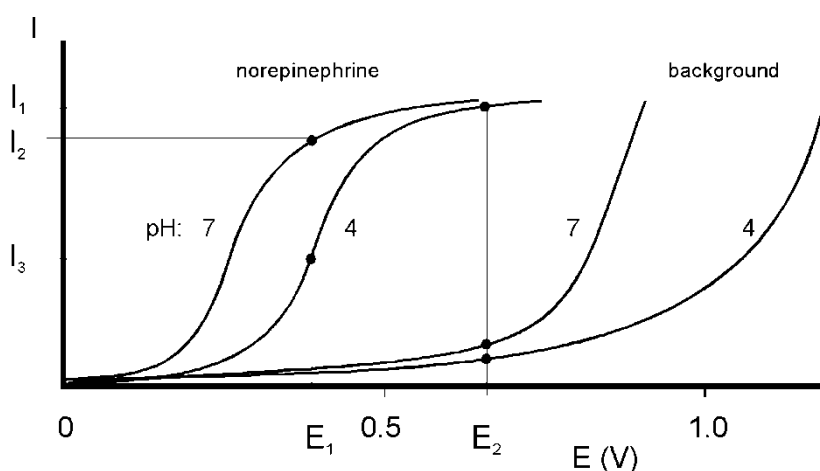

Fig. 36. At a higher pH the I/E curve of norepinephrine is shifted to the left.

Reaction kinetics predict that electrochemical detection is mass flow dependent. When the LC flow is stopped in LC-EC, the analyte will be oxidized completely and the signal decreases rapidly. This means that the flow rate not only affects temporal peak width and analysis time but also peak height. Also the background signal is sensitive towards fluctuations in the flow rate. Therefore, it is important to use a pulse-free solvent delivery system like in the Antec ALEXYS LC-EC analyzer.

Construction of a hydrodynamic voltammogram

Before a hydrodynamic voltammogram can be obtained, the chromatographic conditions should be optimized. Then the following steps are taken:

1. A solution of the analyte at a concentration between 1 - 100 $\mu\text{mol/l}$, is prepared in mobile phase.
2. The electrochemical detector is stabilized in the DC mode at a high potential. After stabilization the background current is read from the display of the detector (I-cell) and the noise is measured.
3. The run is started by injecting the compound. When at the high working potential no signal is obtained, it may be concluded that the compound is not electrochemically active. In such a case derivatization of the compound may be an option.
4. If a peak is measured, the working potential is decreased by 50 or 100 mV and step 2 to 4 is repeated until the lowest potential setting (Fig. 37).
5. The peak heights and the background currents are plotted against the working potential (Fig. 32).

The working potential which gives the best sensitivity is obtained by plotting the signal-to-noise ratio against the working potential.

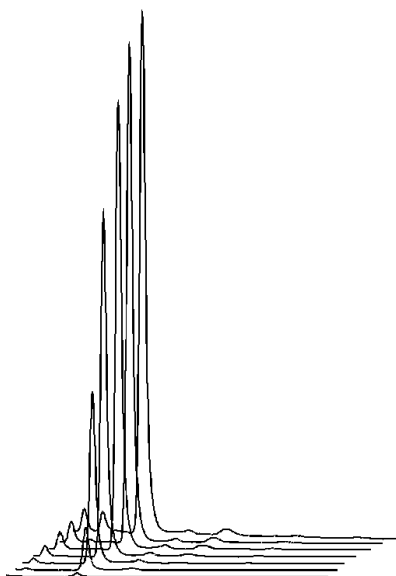

Fig. 37. Construction of a hydrodynamic voltammogram for norepinephrine. Chromatograms are obtained at cell potentials ranging from 1.0 V (back) to 0.4 V (front), with 100 mV steps.

Construction of a scanning voltammogram

A scanning voltammogram can be recorded using the DECADE Elite scan mode. The scan mode is programmed in the 'SCAN SETUP' screen of the DECADE Elite. Depending on the data acquisition software that is used and the experimental set-up, a full, half or continuous scan cycle can be chosen.

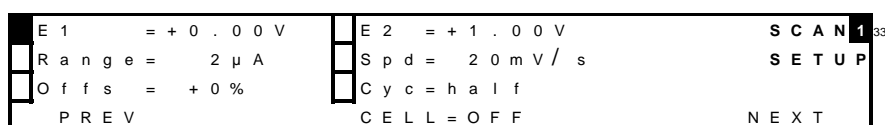

Fig. 38. Programming the scan mode in the 'SCAN SETUP' screen.

With the Elite Dialogue control software a scanning voltammogram can be programmed under the 'Detector' tab in the main window.

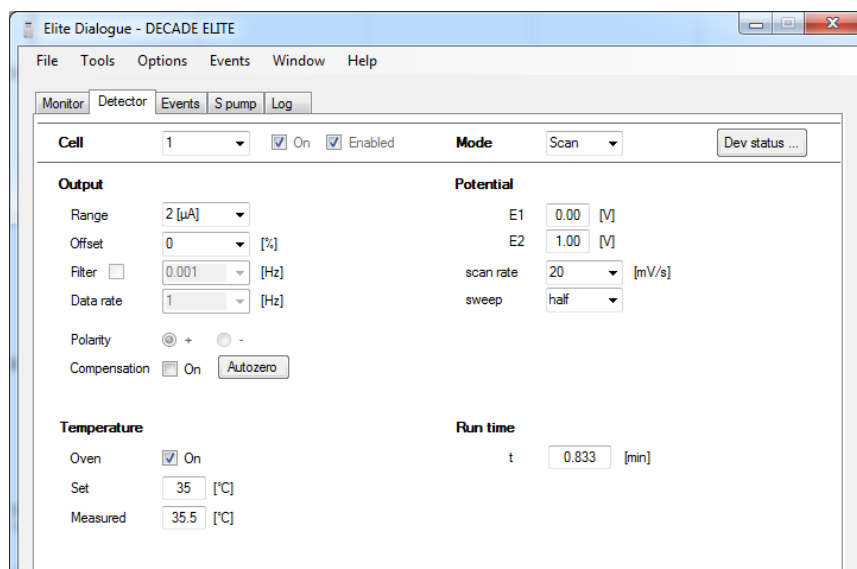

Fig. 39. Programming a scan in the Elite Dialogue software.

In the above example a 'half' scan is programmed, sweeping the potential from 0 V to 1.0 V. A full scan would include the reverse scan, i.e. from 0 V to 1.0 V and back to 0 V. In the continuous mode the voltage is swept up and down between both potentials for a pre-defined run time.

A convenient way to record a scanning voltammogram is by direct infusion of analyte in the flow cell using a syringe pump. In the figure below a scanning voltammetry set-up is shown.



Fig. 40. DECADE Elite scanning voltammetry set-up with a syringe pump.

The Antec dual syringe infusion pump (pn 188.0035) which can be obtained as accessory has as an advantage that it can be controlled in Elite Dialogue software as well.

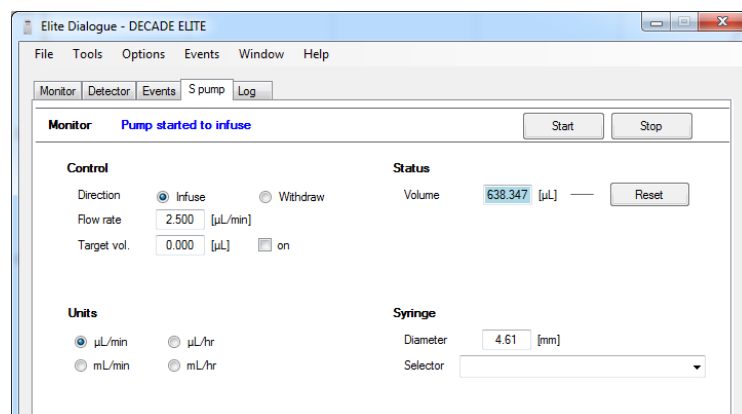

Fig. 41. Programming the Antec infusion pump in Elite Dialogue.

In the example below a half scan is shown at a flow rate of 10 $\mu\text{L}/\text{min}$ of a 20 μM Serotonin (5-HT) standard in mobile phase.

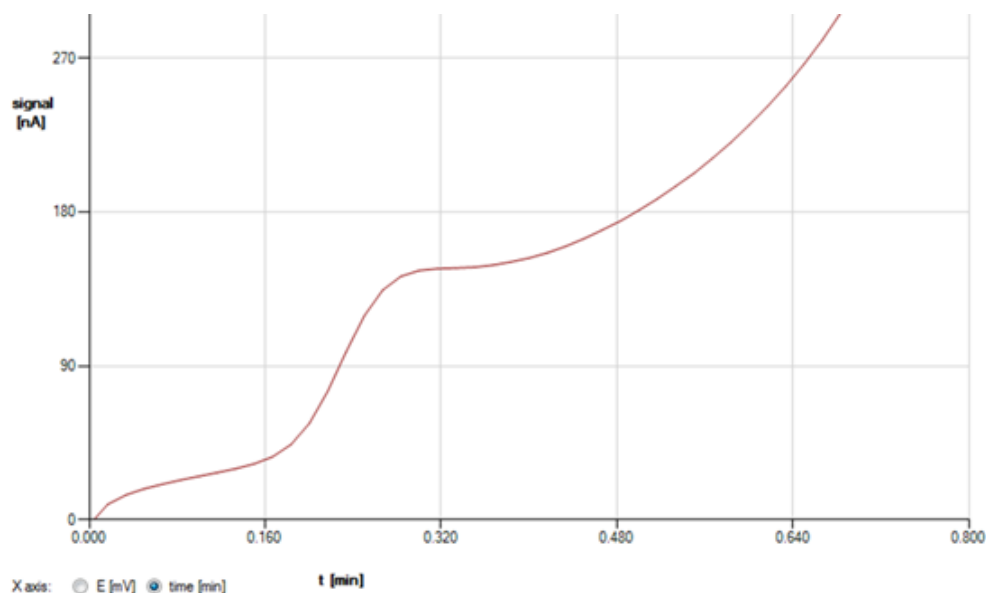

Fig. 42. Scan (cycle: half) of a 20 μM Serotonin in mobile phase at a glassy carbon working electrode. Scan speed 20 mV/s.

The following procedure is advised to record scanning voltammogram of analytes:

- Use a voltammetry set-up as shown in figure 48 (preferably) in combination with the Elite Dialogue software and a syring pump for direct infusion of analyte in the flow cell.



If Dialogue is not used, connect an A/D converter to the analog output of the detector to record the cell current. Set the A/D converter sampling rate to 1 Hz. This is the same frequency as the voltage steps during the scan. If a higher sampling frequency is chosen a typical stepwise pattern may appear. Note that with such set-up only 'I versus t' curves can be obtained.

- Prepare a solution of the pure compound dissolved in (preferably) the HPLC buffer with a concentration in the range of 10-100 μM .
- Set the lower (E1) and upper potential (E2), the scan rate (Spd), range and scan cycle in the 'SCAN SETUP' menu or under the

'detector' tab in Dialogue.

Typical scan settings to start with: E1 0 mV, E2 1000 mV, scan speed 10 mV/s, range 5 μ A/V. Optimize the settings if required for your specific compounds.

- Prime a 1 mL glass syringe with analyte solution and install it in the syringe holder of the pump.
- Program the syringe diameter and flow rate in the syring pump settings menu. In case a syringe pump is used which can be controlled in Dialogue the settings can be programmed under the 'S pump' tab. A typical flow rate to start with is 10 μ L/min. Optimize the flow rate if required during the scan experiments.
- Start the syringe pump and before scanning assure that the flow cell is sufficiently primed with analyte solution.
- A scan can be started (stand-alone) by pressing the 'START' button in the 'SCAN STAT' menu or by starting a single run in Dialogue: press the 'F5' button or click 'start single run' under the 'Options' menu.
- To record a background (blank) scan repeat the experiment with the pure HPLC buffer in which the analyte was dissolved.

When scanning with the Elite Dialogue software ('continuous') all scans are displayed and can be selected individually.

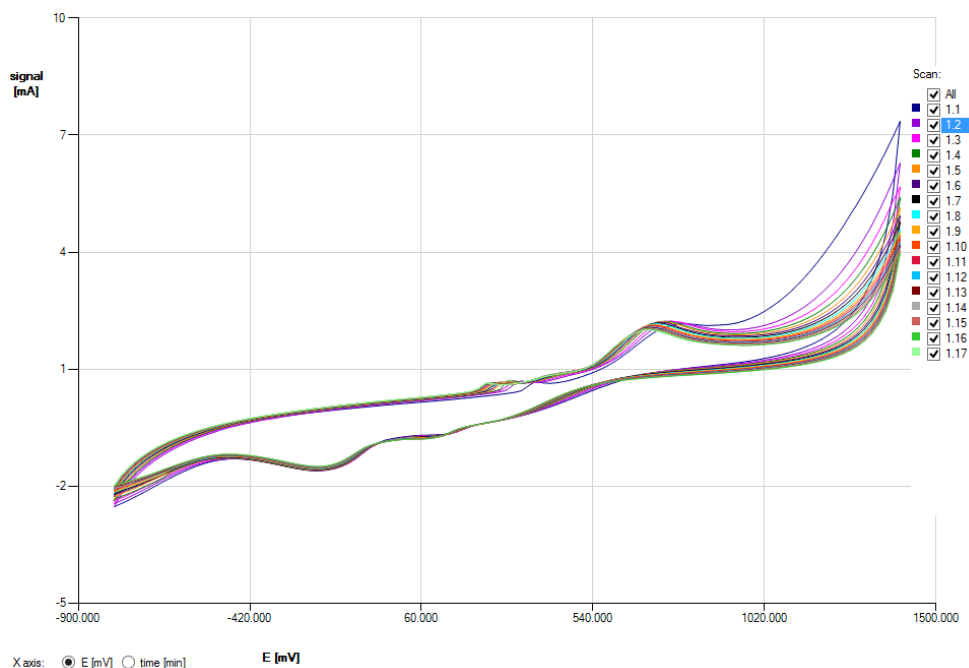

Fig. 43. Example of multiple scans ('continuous') of Amodiaquine.

CHAPTER 10

Specifications DECADE Elite**Environmental, dimensions, weight & power requirements**

Working temperature	10 - 40°C (indoor use only)
Storage temperature	-25 - +50°C
Humidity	20 - 80% RH
Safety and EMC	According to EC-directives; Emission Group I Class A; cMETus approved
Equipment class	1
Installation category	II
Pollution degree	2
Dimensions	43 (D) x 22 (W) x 44 (H) cm = 16.9" (D) x 8.7" (W) x 17.3" (H)
Weight	max 14.4 kg (32 lbs) without flow cell and column
Installation	Install upright on flat & smooth surface, keep space under the detector free (risk of blocking power supply fan).
Power requirements	110-240 VAC, 50/60 Hz, 260 VA, auto-sensing
Mains fuse	2.5 AT / 250V, 5x20 mm, IEC 60127-2 For safety reasons, any other internal fuse or circuit breaker is not operator accessible, and should be replaced only by Antec authorized personnel. Only use manufacturer-supplied fuses.



For optimum analytical performance it is recommended that the ambient temperature of the laboratory be between 20-25 °C and be held constant to within ± 2 °C throughout the entire working day. Note: that for optimal performance of the oven the oven temperature should be set at least 7 degrees higher as ambient temperature.

General

Operating modes	DC, PULSE SCAN (Lite: DC mode only)
Other mode	CONFIG, DIAG and SERVICE
Sensors	Up to 3 flow cells (Lite: single cell only)
Autozero	triggered by keyboard, rear panel TTL, or remote PC control (LAN)
Max. current compensation (Autozero)	25 nA - 2.5 mA in DC and PULSE mode dependent on range setting
Offset	+50% to - 50% of max. output voltage, 5% steps
PC control	Parametric control and data-acquisition via LAN port (USB service port)
Embedded software	Flash technology, upgradeable via PC (USB)
Oven	+7°C above ambient to 60°C, accuracy 0.5°C, stability 0.1°C; accommodates column and flow cell(s)
Rear panel connectors	1x IEC inlet (Mains), 1x USB B, 1x RJ45 LAN, 1x 9-pins sub-D Male (Valve), 1x 9-pins sub-D Female (Analog output), 1x 25-pins sub-D Female (Digital I/O)
Analog output (DAC)	-1 to +1 V full scale (via 16-bit D/A converter)
Analog output (I/E)	-2.5 to +2.5 V full scale (unprocessed I/E converter signal)
Digital I/O (HW)	2x Relay, 5x TTL outputs (CMOS 3.3V logic), 13 TTL inputs (programmable), 1x GND
Programmable I/O functionality	Cell on, Cell off, Autozero, Start, Overload, Relay, Auxiliary
Valve control	VICI valco 2-pos electrically-actuated valve (E2CA, EHCA) via serial cable, Manual valve, 1x inject marker output

DC mode

Range	10 pA - 200 μ A in 1, 2, 5 increments
Filter (ADF)	10 - 0.001 Hz in 1, 2, 5 increments RAW and OFF: for unprocessed data
Potential (Ec)	-2.50 V to + 2.50V with 10 mV increments
Data Rate	1 - 100 Hz in 1, 2, 5 increments, dependent on filter setting
Noise	< 2 pA with dummy cell (load of 300 M Ω /470 pF) in 1 nA range, filter off, Ec +800mV and temperature of 35 °C.

PULSE mode

Range	10 nA - 200 μ A in 1, 2, 5 increments
Filter (ADF)	0.5 - 0.001 Hz in 1, 2, 5 increments OFF: for unprocessed data
Potential (Ec)	-2.50 V to + 2.50 V with 10 mV increments
Data Rate	1/(pulse duration) Hz
Waveform	Max 5 potential steps
Pulse times (t1-t5)	t1: 100 ms - 2000 ms; t2, t3, t4, t5: 0 - 2000 ms in 10 ms increments
Sampling times (ts)	20 ms - [t1 - 60] ms

SCAN mode

Range	10 nA - 200 μ A in 1, 2, 5 increments
Potential (Ec)	-2.50 V to + 2.50V with 10 mV increments
Data Rate	1 Hz
Scan rate	1 - 100 mV/s in 1, 2, 5 increments
Cycle	Half, Full, Continuous

CHAPTER 11

Rear panel I/O

In this chapter all rear panel functionality is described. The DECADE Elite has besides the mains inlet in total 5 connectors on the rear panel for communication, data output and I/O. A photo of the rear panel connectors is shown below for reference.

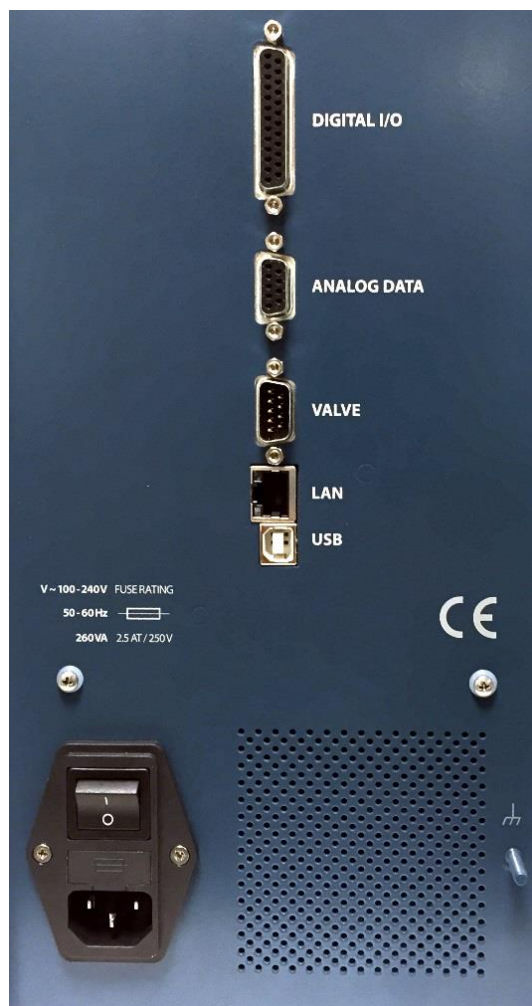

Fig. 44. DECADE Elite rear panel.

USB B connector

USB type B connector for serial instrument control over USB, for service use only:

- Based on USB-to-serial UART interface using the FT232R chip from FTDI (Future Technology Devices International Ltd).
- FT232R is fully compliant with USB 2.0 specifications.
- Fixed communication baud rate: 921600 bps
- Communication over USB is used for software (FW) update of the instrument only using Antec boot loader FW upload utility

LAN connector

RJ-45 bus for serial instrument control over LAN:

- 10Base-T or 100Base-TX (Auto-Sensing) serial-to-ethernet connectivity.
- Network configuration of Xport via Lantronix device installer software utility.
- Fixed communication baud rate: 921600 bps
- Communication over LAN is used for parametric instrument control and data-acquisition.



To establish communication over LAN the LAN cable must be connected when starting the detector using the mains power switch on the rear panel. If no communication cable (either LAN or USB) is connected during start-up, communication via USB is enabled (default).

VALVE connector

Serial D9 (9-pins subD male) valve control connector for electrical (Vici) and manual valves:

- Serial (RS232) valve control of Vici 2-position electrically actuated valves via pin 1 - 3 (see Vici technical note tn413.pdf on the official www.vici.com web site). Compatible with the E2CA and EHCA actuator control module.

- Automatic detection of electrically actuated Vici valve, valve control in: STAT screen and RS232 command ID 30 (0=load, 1=inject).
- Manual valve status (load/inj) read-out via pin 5 and 6 (contact closure).
- Inject Marker (pin 9) TTL output. Default: high 3.3V (load), on inject event: low (0 V) for 2000 ms.

Valve configuration

A Vici electrically-actuated 2-position valve is automatically detected during start-up of the instrument. Automatically the Valve parameter in the IO menu is set to Valve = Present.

Temp = 35° C	Contrast = 20	CONF I G
Valve = Present	Vout source = DAC	
	ID1 master = no	
PREV	IO	



Always restart the detector (by re-powering via the mains switch on the rear panel) when connecting the valve for correct initialization of an electrically-actuated Vici valve.

In case of a manual Valve configuration has to be done manually, by setting the Valve parameter in the IO menu to Valve = 'Present'.

Valve connector layout

In the table below the connector layout is shown for the Valve connector.

Table V. Valve connector lay-out.

Pin	Layout
1	GND
2	TRANSMIT(TxD)
3	RECEIVE (RxD)
4	-
5	GND
6	SWITCH (Hand valve)
7	-
8	-
9	INJECT MARKER

For a manual valve the status (LOAD/INJ) read-out is established by connecting the LOAD/INJ sensor wires/leads of a manual valve to pin 5 and 6 (contact closure).

Inject marker

A connected valve enables the inject marker (pin 9)]. The contact is high when the valve is in 'load' position (3.3V), and low (0V) in the 'inject' position. On an inject event the contact will go to 0V (low) for 2000 ms, It can for example be used to start the integration software when injection is done.

Valve control

In stand-alone mode the valve position can be controlled via the F5 function button in the STAT screen. For example see the screen dumps of the STAT screen for a DECADE Elite SCC (top) and TCC detector. INJ=L represents the LOAD position (position A on the actuator control module) and INJ=I represents the INJECT position (B on the actuator control module). The LOAD position is the default position at start-up of the instrument.



Make sure that the valve flow path is connected correctly and LOAD corresponds with position A and INJECT with position B. See example in the figure below for a 6-port valve.

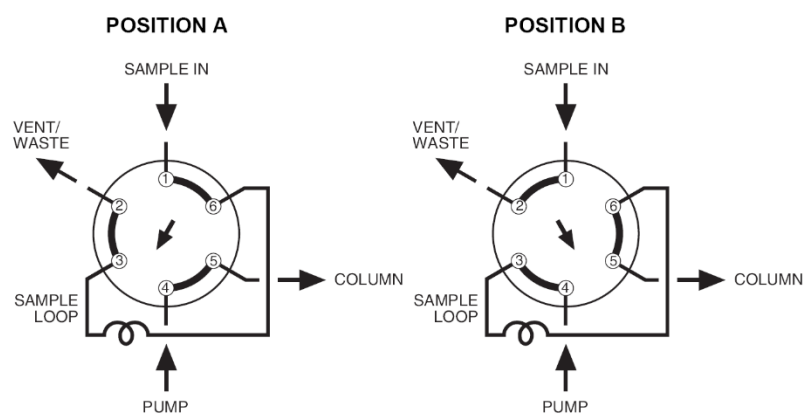

Fig. 45. Example of the valve flow path of a 6-port valve.

```

Vout = +0.057 V      Ic = +23.45 nA      DC 1
Range = 50 nA       Ec = +0.50 V      STAT
Filt = .002 Hz      Comp = off 25 > 30 °C 211.20
PREV CELL=ON MARK AZERO INJ=L

```

```

1 D Ic = +23.45 nA      STAT 1
2 P Ic = +120.6 nA
3 D Ic = +2.665 nA     25 > 30 °C  [ ] Comp = OFF
PREV CELL=ON MARK AZERO INJ=L

```

In the case of a manual valve the information above the F5 button (INJ=L) in the STAT screen shows the status (position) of the valve only, no valve control is possible with this type of valve.



For information about valve control of the electrically-actuated VICI valves in the Clarity chromatography software or Elite Dialogue please refer to the corresponding user manuals.

ANALOG DATA connector

The DECADE Elite is equipped with an analog data output connector to provide the measured signals in millivolts (mV) for users who work stand-alone without PC control with the instrument. The ANALOG DATA connector (D9-female) can either be connected to an X-Y recorder or A/D converter. The ANALOG DATA output can supply either a non-manipulated signal directly from the I/E converter, or the processed data signal by the CPU of the DECADE Elite. The type of output can be selected from the CONFIG screen by setting the parameter Vout source to either DAC or I/E.

```

Temp = 35 °C      Contrast = 20      CONFIG
Valve = Present  Vout source = DAC
                  ID1 master = no
PREV IO

```

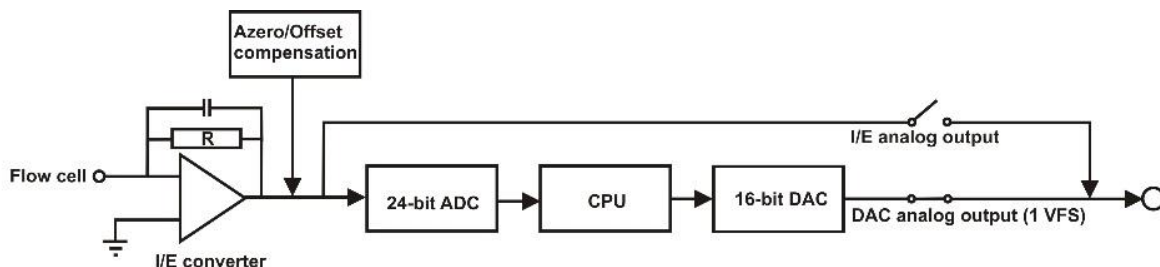

Fig. 46. Top: CONFIG screen. Bottom: DECADE Elite signal processing from electrochemical flow cell to output. R is a selectable I/E resistor of 100M, 10M, 1M, 100K or 1K in the I/E converter circuit.

DAC output

The DAC output is the processed signal by the DECADE Elite's CPU and is identical to that of the digital cell current signal obtain via data-acquisition over LAN using the Elite Dialogue or the Clarity Chromatography software.

The signal in mV from this output is directly related to the range setting of the DECADE Elite. So for example in the case the 200 μA measurement range is selected 'Range = 200 μA ' the DAC signal on the analog data connector corresponds with +1000 mV = +200 μA and -1000 mV = -200 μA (so +/- 1V full scale). To convert the signal in mV to the actual cell current in nA use the following calculation:

$$I_c (\text{nA}) = \frac{V_{\text{out}} (\text{mV})}{1000 \text{ mV}} \times \text{Range setting (nA)}$$

So for example a signal on the output of 250 mV in the 200 nA range corresponds with an actual cell current of $(250/1000) \times 200 \text{ nA} = 50 \text{ nA}$.

I/E output

The I/E output is the unprocessed analog signal from the I/E converter circuit. This signal is a true analog signal which is as close as practically possible to the working electrode (WE). The maximum output voltage of the I/E output is +/- 2.5V under all conditions and is independent of the detector range setting. The signal in mV is related to the selectable I/E resistor of 100M, 10M, 1M, 100K or 1K in the I/E converter circuit. The actual cell current can be calculated from the analog I/E output in Volt using the following formula:

$$I_c (\text{Ampere}) = \frac{V_{\text{out}} (\text{Volt})}{R_{\text{I/E}} (\text{Ohm}) \times 10}$$

So for example an I/E output signal of 250 mV in the 5 nA range ($R_{\text{I/E}} = 10 \text{ M}\Omega$) corresponds to an actual cell current of $0.25\text{V}/(10 \times 1\text{E}7\Omega) = 2.5\text{E-}9\text{A} = 2.5 \text{ nA}$. In the table below, the I/E resistor value is listed for every range setting.

Table VI. DECADE Elite I/E converter resistors

Current Ranges	I/E Resistor (Ohm)
10pA, 20pA, 50pA, 100pA, 200pA, 500pA and 1nA	100M
2nA, 5nA	10M
10nA, 20nA, 50nA	1M
100nA, 200nA, 500nA, 1µA, 2µA	100K
5µA, 10µA, 20µA, 50µA, 100µA, 200µA	1k

In the detector accessory kit a dedicated Output cable, D9 male – open, 2m (pn 250.0128A) is supplied. It is advised to use this manufacturer-supplied cable for this type of measurements.

For reference, the layout of the analog data out connector is shown in the table below.

Table VII. Analog data output connector lay-out.

Pin	Layout
1	Vout 1
2	Vout 2
3	Vout 3
4	Vout 4
5	Vout 5
6 - 9	GND

To measure for example the analog signal of cell 1 with an external A/D converter:

- Connect the signal wire, lead of pin 1 (V_{out1}), to the analog measurement channel of the A/D converter.
- Connect the GND wire, lead of pin 6 (or 7-9V), to the corresponding analog ground connection of the A/D converter.

Digital I/O connector

The detector has one 25-pins digital I/O connector which enables control of (or by) external equipment. The IO connector contains 18 TTL contacts (5 outputs and 13 inputs, 3.3V CMOS logic), 2 RELAYS (contact closure) and 1 ground (GND connection).

TTL inputs & outputs

Both the TTL inputs and outputs are default = high (3.3 Volt). The TTL inputs are level triggered: the contacts require a minimum TTL-low pulse duration of 100 ms. If multiple activations are required the next pulse should be given after 100 ms TTL high. When the input is kept low, only one activation will occur.

Relays

The DECADE Elite has 2 free programmable contact closure outputs:

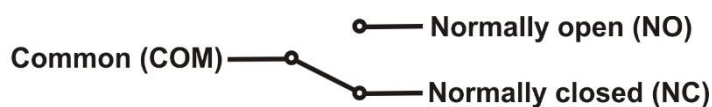

- Relay1: pin 1 normally closed, pin 2 normally open, pin 3 common.
- Relay2: pin 4 normally closed, pin 5 normally open, pin 6 common.

The maximum rating for these contact closure outputs are 24 VDC (switching voltage) and 0.25 A. The relays can be controlled in the Elite Dialogue software and Clarity Chromatography software.

AUX

The DECADE Elite has 4 free programmable TTL outputs AUX1 – AUX4 (pin 7 – 10). These contacts are default 'high' 3.3V (inactive), when active the status is 'low' 0V.

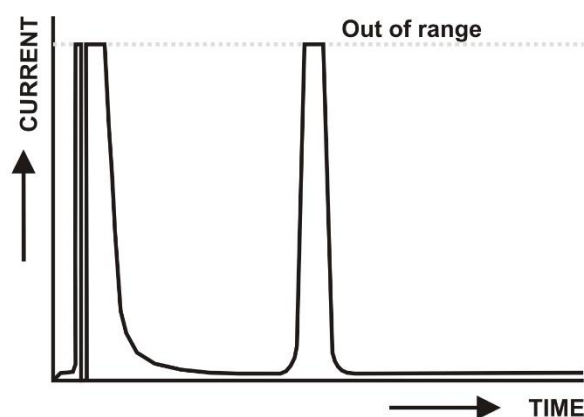

Fig. 47. Example of a chromatogram were the cell current exceeds the maximum current level and the signal is 'out of range'.

Overload

The overload output (pin 11) can be used to monitor if the cell current goes out of range during a chromatographic run. An 'Out of range' error appears when the cell current I_{cell} exceeds the limit of the current range at which the measurement is performed. See figure below.



It is important to recognize an 'out of range' (overload) situation, because it may lead to erratic results when quantifying analyte concentrations in samples.

If for instance the cell current goes in out of range during the recording of an analyte peak, it can be (in most cases) easily recognized by a flat top of the peak and a very abrupt transition to the flat top at the edges.

By default the status of the overload output is 'high' 3.3V. When the cell current has the status 'out of range' the overload output will change status to 'low' 0 Volt, until the cell current returns to a value within the measurement range again.

The overload output (pin 11) is one of the configurable I/O's.

```

P 1 1 ( O V L D ) = 1
P 1 2 ( C - O N ) = A L L
P 1 5 ( C - O F F ) = 2
P R E V
P 1 8 ( A Z E R O ) = 1
P 2 1 ( S T A R T ) = A L L
I O

```

The configurable I/O's can be programmed in the IO menu, which is a sub-menu of the CONFIG menu. By default, the overload output is assigned to cell 1: 'P11 (OVLD) = 1'. This means that only when the cell current of cell 1 is 'out of range' the status of the overload output will change to 'low' 0V. For all other cells present in the DECADE Elite (in case of a DCC or TCC version of the instrument) an out of range situation will not trigger a response on pin 11. The following options can be selected for the configuration of pin 11:

P11(OVLD) = 1	Overload output active for cell 1 only
P11(OVLD) = 2	Overload output active for cell 2 only
P11(OVLD) = 3	Overload output active for cell 3 only
P11(OVLD) = 4	Overload output active for cell 4 only
P11(OVLD) = 5	Overload output active for cell 5 only
P11(OVLD) =	Overload output inactive
P11(OVLD) = All*	Overload output active for all cells present

*) When this option is selected, the overload output will be active for all cells present in the DECADE Elite. If the cell current of either one of those cells will go 'Out of range' the overload input pin 11 will become active.

Cell on, Cell off

The DECADE Elite has 3 TTL inputs to switch on cells (pin 12 – 14) and also 3 inputs to switch off cells (pin 15 -17) AUX1 – AUX4 (pin 7 – 10). This input command can be used for example to switch on and stabilise the flow cell early in the morning by means of a timer. Two of the inputs are configurable (pin 12, pin 15, cell on and off respectively) in the IO menu (see previous chapter about the overload output). The configuration settings of these inputs are: 1, 2, 3, 4, 5, ' ', and all. In case 'all' is selected all cells present in the DECADE Elite will be switched on or off when the corresponding input is triggered.

Autozero

The DECADE Elite has 3 TTL inputs (pin 18 – 20) available to autozero the cell current of the cell(s). Triggering these inputs enables external activation of the auto zero command. This function is active only when the 'I-cell' is displayed. One autozero input is configurable (pin 18) in the IO menu (see previous chapter about the overload output). The configuration settings of this input are: 1, 2, 3, 4, 5, ' ', and all. In case 'all' is selected the cell current of all cells present in the DECADE Elite will be zeroed when the input is triggered.

Start

The DECADE Elite has 4 TTL inputs (pin 21 – 24) available to start data-acquisition and/or start a scan. One start input is configurable (pin 21) in the IO menu and can be used for example to start the data-acquisition of all cells synchronously using only one trigger input when the setting 'All' is selected.



The manufacturer will not accept any liability for damage, direct or indirect, caused by connecting this instrument to devices that do not meet the relevant safety standards.

Table VIII. DIGITAL I/O connector layout.

Pin	Type I/O	Function (default)	Configurable I/O	Description
1,2,3	Relay 1	Relay 1	-	Contact between 3 (common) and 1 (default), activated by time file Outp 0100 or RS232 command 47
4,5,6	Relay 2	Relay 2	-	Contact between 6 (common) and 4 (default), activated by time file Outp 0001 or RS232 command 47
7	TTL OUT	AUX 1	-	Free programmable TTL output, activated by time file Outp 0001, RS232 or command 47
8	TTL OUT	AUX 2	-	Free programmable TTL output, activated by time file Outp 0010, RS232 or command 47
9	TTL OUT	AUX 3	-	Free programmable TTL output, activated by RS232 command 47
10	TTL OUT	AUX 4	-	Free programmable TTL output, activated by RS232 command 47
11	TTL OUT	Overload	A*, 1-5	Active in case of signal overload ('OUT OF RANGE', 'PAD OVLD')
12	TTL IN	Cell on 1	A, 1-5	Trigger to switch the cell on
13	TTL IN	Cell on 2	-	Trigger to switch the cell on
14	TTL IN	Cell on 3	-	Trigger to switch the cell on
15	TTL IN	Cell off 1	A, 1-5	Trigger to switch the cell off
16	TTL IN	Cell off 2	-	Trigger to switch the cell off
17	TTL IN	Cell off 3	-	Trigger to switch the cell off
18	TTL IN	Autozero 1	A,1-5	Trigger to zero/null the cell current (compensation I _c)
19	TTL IN	Autozero 2	-	Trigger to zero/null the cell current (compensation I _c)
20	TTL IN	Autozero 3	-	Trigger to zero/null the cell current (compensation I _c)
21	TTL IN	Start 1	A,1-5	Trigger to start a Timefile, Scan and Data-acquisition
22	TTL IN	Start 2	-	Trigger to start a Timefile, Scan and Data-acquisition
23	TTL IN	Start 3	-	Trigger to start a Timefile, Scan and Data-acquisition
24	TTL IN	Start 4	-	Trigger to start a Timefile, Scan and Data-acquisition
25	GND	GND	-	Ground connection

*) A = All boards. In the detector accessory kit a dedicated I/O cable, D25 male - open, 2m (pn 250.0131) is supplied.

CHAPTER 12

Troubleshooting

Maintenance Even though great care was taken in the design of the DECADE Elite, problems may occur during operation of the instrument. The information in this chapter may help you to identify and solve the source of the problems. Errors can be categorized in two types:

- Instrument errors
- Analytical problems

In the next sections both types of errors are described. In the event that the problems cannot be solved after following the instructions in this troubleshooting section, contact your local supplier for further assistance.

Instrument errors

Incidental fault conditions may occur in any instrument. The DECADE Elite will generate an error message containing an error number with a short description for several hardware fault conditions.

Table IX. Error messages.

Error	Message
11	Checksum error
12	Temperature sensor 1 error
13	Disconnect flow cell x
14	Control board SRAM error
20	Checksum error

Please contact your local supplier if one of the above errors occur for further instructions. In the case the instrument does not power up at all check the following remedies.

No detector response

Possible cause	Remedy
No power	Check line voltage setting, plug in power cord
Power switch off	Turn this switch ON (at the rear panel)
Faulty fuse	Replace fuse
Divergent mains voltage	Check line voltage



Make sure the DECADE Elite is connected to a grounded power source with a line voltage which is within the specified ratings. If the DECADE Elite does not respond, a fuse in the mains inlet may be blown.

Furthermore the following messages can be displayed on the LCD screen during a measurement:

Table X. Messages.

Message	Advice
01 Out of range*	Output is either above +1.0V or below -1.0V. Pressing AZERO may give an adequate read-out again. If the message remains after pressing AZERO, the autozero function is unable to compensate the background cell current. Advice: use a less sensitive range in the SETUP menu.
02 PAD overload	Charging current in pulse mode out of range. Pressing AZERO may give an adequate read-out again. If not, it is advisable to change the pulse settings (increase t1) or use a less sensitive range.

Make sure that maintenance is performed on a regular basis.

*) An 'Out of range' error appears when the cell current I_{cell} exceeds the limit of the current range at which the measurement is performed. See figure below.

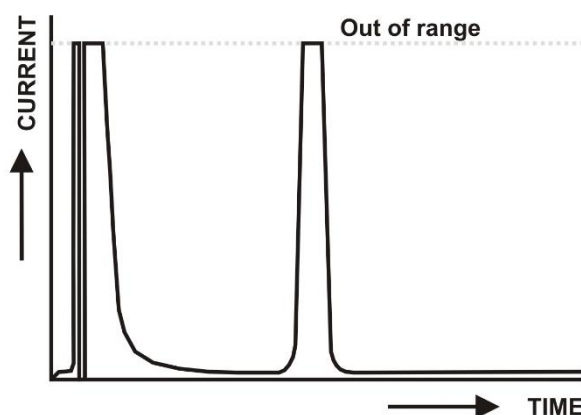

Fig. 48. Example of a chromatogram where the cell current exceeds the maximum current level and the signal is 'out of range'.



It is important to recognize an 'out of range' (overload) situation, because it may lead to erratic results when quantifying analyte concentrations in samples.

Analytical troubleshooting

Analytical problems like loss of signal, increase in noise level, high cell current, loss in sensitivity etc. may occur in any (U)HPLC-ECD system. It may be hard to find the cause and several checks need to be performed to eliminate the source of the problem. The first step is to determine whether the problem is caused by the DECADE Elite electrochemical detector or the rest of the (U)HPLC system. For that purpose two basic checks should be performed by the end-user:

- Dummy cell test
- Stop flow test

Dummy cell test: The outcome of the dummy cell test, which is described in the next paragraph will give an indication if the problems are caused by the detector hardware (electronics).

Stop flow test: The stop flow test will eliminate if the problems are caused by the electrochemical flow cell, or is originating from the rest of the (U)HPLC system (pump, autosampler, pulse damper, column, mobile phase etc.)

Dummy cell test

External dummy cell

An external dummy flow cell (pn 250.0040) is shipped with every DECADE Elite instrument for troubleshooting purposes and maintenance checks. A successful dummy cell test confirms that the controller, including the cell cable, functions properly. If the result of the noise measurement with the dummy cell is within specs, the controller is excluded in a troubleshooting procedure.

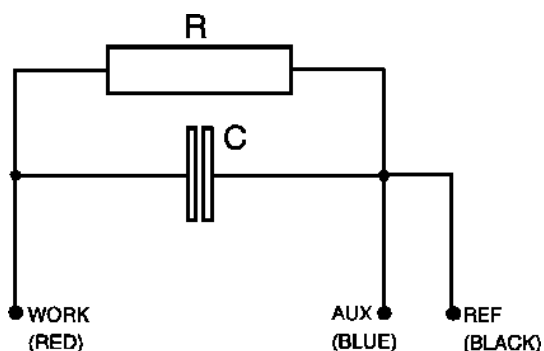

Fig. 49. Left: schematics of external dummy flow cell. Right: photo of the external dummy flow cell (pn 250.0040).

The dummy flow cell consists of a resistor (R) of 300 MΩ and a capacitor (C) of 0.47 μF in parallel. The current is measured over the resistor according to Ohm's law ($V = I \times R$), hence with a working potential of 800 mV the current drawn will be about 2.67 nA. Slight differences as to this (ideal) value are due to the tolerance of the resistor ($\pm 1\%$). The capacitor functions as a 'noise generator' and in fact resembles the capacitance of a well-functioning VT-03 flow cell in an ideal (U)HPLC set-up. The noise generated via the dummy should be less than 2 pA if the filter of the controller is set to off, provided that the dummy is within the fully closed Faraday shield at the same position as the flow cell.

Table XI. Dummy cell test settings.

Parameter	Setting
Cell potential	800 mV
Oven	35 °C, stable
Filter	off
Range	1 nA/V

Test criteria:

- $I_{\text{cell}} = 2.67 \pm 0.05 \text{ nA}$
- Noise $< 2 \text{ pA}$



The results (cell current and noise) of the dummy cell test should be within the above mentioned test criteria. If the current value I_{cell} and the noise are not within the criteria it is an indication that something could be wrong with the detector hardware. Please consult your local representative.

Internal dummy cell

The DECADE Elite also has the option to run a so-called internal dummy cell test. This exclusively checks the performance of the electronic circuit boards (amplifier circuitry) only, so it excludes the cell cables and the external dummy flow cell. From the MAIN screen DIAG can be selected to enter the DIAG screen, followed by selecting NOISE. This activates a timer in the NOISE screen, and after 5 min stabilisation auto zero is activated and the dummy cell test is ready. Noise of the internal dummy cell can be measured at the output. As with the external dummy cell the noise should be better than 2 pA. Detector settings in the NOISE screen are the same as in the external dummy cell test with the exception of the oven temperature. Temperature is switched off.

```

Please wait
stabilizing cell current
time remaining 05:00
NOISE 43
PREV
```

In the NOISE screen, the cell current is shown and the output voltage.

```

Vout = +0.007V      Ic = +2.667 nA
NOISE 27
PREV
```

Stop flow test

The stop flow test is a basic test to check if the problems are related to either the flow cell or the rest of our (U)HPLC system. Perform the following steps to execute the stop flow test:

- Switch off the (U)HPLC pump.
- Disconnect the tubing connection from the column outlet (see figure below).

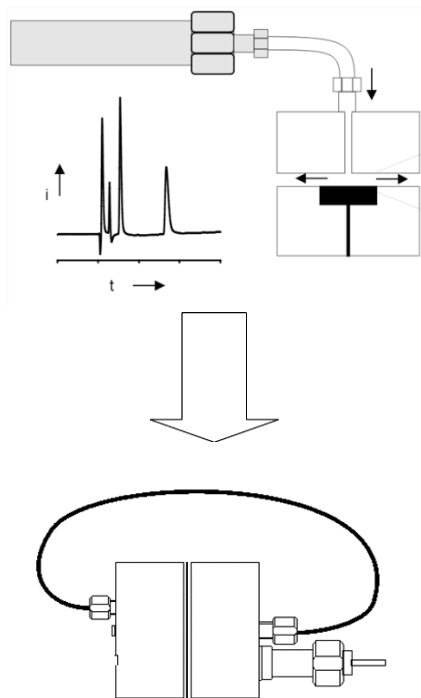

- Disconnect the outlet tubing from the flow cell.
- Connect the other end of the tubing (of the tubing connected to the inlet of the flow cell) to the outlet of the flow cell.
- The fluidic path of the flow cell is now completely isolated from the rest of the LC system.
- Record a run (without injection of sample) to measure/evaluate the background cell current (I_{cell}) and noise.
- Compare the obtained values of the cell current and noise with the values observed before the stop flow with the pump on.

Results:

I_{cell} : In case a significant drop in I_{cell} is observed, for example a drop of more than 50%, it is an indication that the problem is not flow cell related but originates from other parts of the LC system. The most obvious reasons for a high background current are electrochemically active contaminants in the mobile phase, column bleeding, leaking pulse damper. This causes can be systematically eliminated by replacing the mobile phase or disconnecting column or pulse damper etcetera, and re-evaluate the cell current.

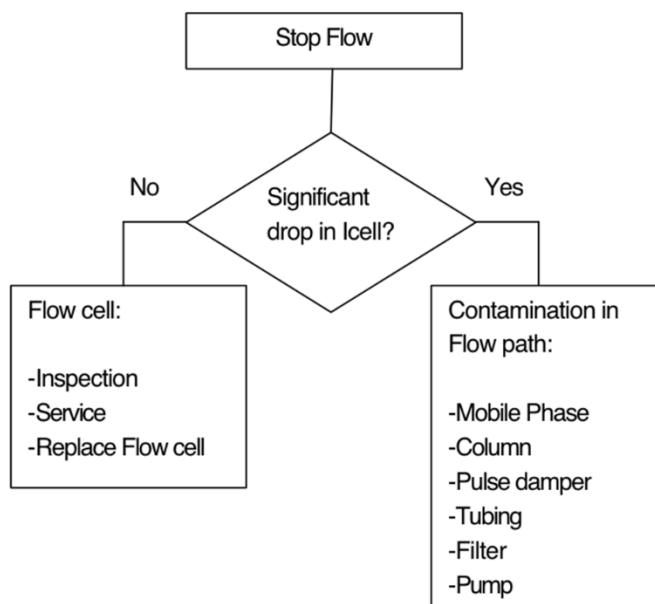

Noise: If a significant drop of the noise only is observed it could be signature of for example pump problem (check valves, air in pump head, compressibility issues or leaking seals).

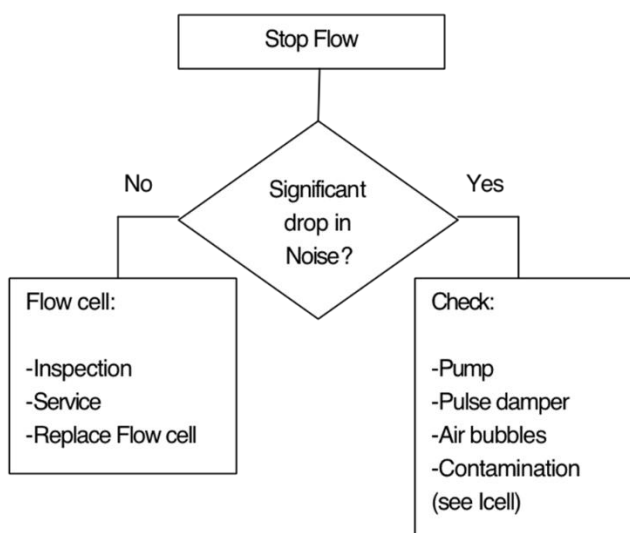

In case no significant drop in noise or cell current is observed service or replace the cell. In case you still cannot solve the problem contact your local representative.



Please bear in mind that analytical problems may also be caused by external

Influences like temperature, unstable samples. Make sure that the application was running trouble-free before and that no changes have been made to the system. A number of causes and possible solutions for analytical problems is listed below. Contact your local representative if you need further help.

No detector response

Possible cause	Remedy
No power	Check line voltage setting, plug in power cord
Power switch off	Turn this switch ON (at the rear panel)
Faulty fuse	Replace fuse
Divergent mains voltage	Check line voltage
Cell disconnected, or switched off	Check connection
Output disconnected	Check connection
Fouled WE	Clean WE

High cell current

Possible cause	Remedy
Contaminated buffer	Replace buffer, do not recycle the buffer
High WE potential	Optimise potential, if possible: use smaller WE diameter
Salt bridge in REF not saturated	Refill with wetted KCl crystals
Retained peaks from previous runs	Wait for elution of these (very) broad peaks
Column is 'bleeding'	Replace column
High amount of Fe ²⁺ in buffer	Add EDTA to buffer, rinse metal parts with 15% HNO ₃

Noisy baseline

Possible cause	Remedy
Salt bridge in REF not saturated	Refill with saturated KCl, add wetted KCl crystals
Air bubble in REF or in cell	Remove air bubble, continuously degas the mobile phase
Slow temperature fluctuations	Isolate detector cell, set oven temperature
Fouled WE	Clean WE
Leaking REF or cell	Tighten connections with care

Decreased sensitivity (low S/N ratio)

Possible cause	Remedy
Fouled WE by dirty samples	Clean WE, if possible: dilute samples
Cell potential too low	Optimise potential
Contaminated buffer (high I_{cell})	Replace buffer, do not recycle the buffer

Saturation of output

Possible cause	Remedy
Damaged REF	Check with spare REF, replace if necessary
Damaged WE	Replace cell block
Cell incorrectly connected	Check connections (REF: black, WE: red, AUX: blue)
Cell potential too high	Optimise cell potential

Base line oscillations

Possible cause	Remedy
Malfunctioning pump (regular pattern)	Check pump (seals, valves)
Over-tightened cell bolts	Adjust cell bolts, check pump pressure
Air bubbles in cell or REF	Maintenance REF
Temperature oscillations	Set oven temperature
Contaminated buffer (high I_{cell})	Replace buffer, do not recycle the buffer
Fouled WE	Clean WE
Fe^{++} in buffer	Add EDTA, passivate metal parts with HNO_3

CHAPTER 13

Detector accessories

The electrochemical detector is shipped together with a number of parts. The listing in Table below may not be complete, see check list of delivery for complete listing.

Table XII. Accessory kit (pn 175.0200) DECADE Elite detector

Part number	Component
250.0040	External dummy flow cell
250.0107	Column clamp 12 mm
250.0102*	Cell clamp kit 40 mm
250.0113	Fuse 2.5 AT 250 V
250.0170	LAN (UTP) cable, crossed, 3 meter
250.0175	USB cable, A-B, 3 meter
250.0131	I/O cable, D25 male - open, 2m
250.0128A	Output cable, D9 male – open, 2m
250.0116	Mains cable (Europe)
250.0118	Mains cable (USA)
250.0126A	Elite cell cable

*) for the VT-03 flow cell pn 250.0102 Cell clamp kit 40 mm is available in the accessory lit.

For a Vici Valco electrically-actuated 2-position valve, with an E2CA, EHCA actuator a serial cable is available for control via the DECADE Elite detector: pn 250.0190 Serial valve cable, Valco, 2m.

For these and other DECADE Elite parts or flow cells contact your local supplier.

Index

ADF, 67
Amplitude response, 71
auxiliary electrode, 57
Buffer pH, 31
buttons DECADE II keyboard, 41
cleaning of detector, 38
compensation, 62
cut off frequency, 72
degassing mobile phase, 34
digital filter, 70
DSP, 71
dual flow cell control, 59
dual flow cell navigation, 61
dummy cell
 external, 114
 internal, 115
E1, control, 48
E2, control, 48
EDTA, 31
electrochemical reaction, 84
filter, 48, 64, 70
frequency, 67
fuses
 replacement of, 10, 38
I/E converter, 57, 59
I/E relationship, 83
inject marker, trigger, 103
installation
 DECADE II, 17, 121
integrator
 connection of trigger, 103
Ion strength, 31
keyboard DECADE II, 41
maintenance
 cleaning of detector, 38
maximum compensation, 62
messages, 111, 112
mobile phase requirements, 31
noise, 34, 36, 78, 90, 119
noise filters, 70
offset, 63
output

- frequency, 80
- pulse mode, 80
- passivation with nitric acid, 34
- polarity, 63
- potential**
 - optimisation**, 83
- pulse mode
 - characteristics, 78
 - literature references**, 81
 - optimisation**, 79
 - output frequency, 80
 - potential settings, 79
 - working electrode**, 80
- pulsed amperometric detection, 77
- range, 62
- reference electrode, 57
- rotor Tefzel, 78
- rotor Vespel, 78
- S/N ratio, 90, 119
- scan mode
 - example, 91
 - scanning voltammogram, 86
- specifications DECADE II, 95, 99
- Symbols, 7
- t1, control, 51
- Tefzel rotor, 78
- three-electrode configuration, 57
- ts, 78
- Vespel rotor, 78
- voltage clamp, 57
- voltammogram
 - construction, 85, 90
 - introduction, 83
- warning sign, 7
- working electrode, 57
 - material**, 80