

Science Together



Azura

Column Thermostat CT 2.1 Instructions



Document no. V6811

HPLC



Note: For your own safety, read the instructions and observe the warnings and safety information on the device and in the instructions. Keep the instructions for future reference.



Note: In case you require this instruction in another language, please submit your request including the corresponding document number via e-mail or fax to KNAUER.

Support: Do you have questions about the installation or the operation of your instrument or software?

International Support:

Contact your local KNAUER partner for support:

www.knauer.net/en/Support/Distributors-worldwide

Support in Germany

(Austria & Switzerland on case-to-case basis):

Phone: +49 30 809727-111 (workdays 9-17h CET)

Fax : +49 30 8015010

Email: support@knauer.net

Publisher: KNAUER Wissenschaftliche Geräte GmbH

Hegauer Weg 38

14163 Berlin

Germany

Phone: +49 30 809727-0

Fax: +49 30 8015010

Internet: www.knauer.net

E-Mail: info@knauer.net

Version information: Document number: V6811

Version number: 1.2

Release date: 2020/10/06

Translation of the original edition

These instructions apply to products with the product number: ATCXXYYZZ

The information in this document is subject to change without prior notice. For the latest version of the instructions, visit our website: www.knauer.net/library.



Sustainability: The printed versions of our instructions are printed according to Blue Angel standards (www.blauer-engel.de/en/uz195).

Copyright: This document contains confidential information and may not be reproduced without written consent of KNAUER Wissenschaftliche Geräte GmbH.

© KNAUER Wissenschaftliche Geräte GmbH 2020
All rights reserved.

AZURA® is a registered trademark of
KNAUER Wissenschaftliche Geräte GmbH.

Table of contents

1. General	1
1.1 About these instructions	1
1.2 Signal words	1
1.3 Additional typographical conventions	1
1.4 Legal information	2
1.4.1 Liability limitation	2
1.4.2 Transport damage	2
1.4.3 Warranty conditions	2
1.4.4 Declaration of conformity	2
2. Basic safety instructions	3
2.1 Intended use	3
2.1.1 Operating ranges	3
2.1.2 Foreseeable misuse	3
2.2 User qualification	3
2.3 Operator responsibility	4
2.4 Personal safety equipment	4
2.5 Safety features on the device	4
2.6 Working with solvents	5
2.6.1 General requirements	5
2.6.2 Contamination by health-threatening solvents	5
2.6.3 Avoiding leakage	5
2.7 Specific environments	5
2.7.1 Earthquake-endangered areas	5
2.7.2 Explosive environment	6
2.7.3 Cooling room	6
2.7.4 Wet room	6
2.8 Maintenance, care, and repair	6
2.9 Service request form	6
3. Product information	7
3.1 General	7
3.1.1 Optional accessories	7
3.1.2 GLP data	7
3.2 Scope of delivery	7
3.3 Views	8
3.4 Symbols and signs	9
4. Installation and initial startup	11
4.1 Unpacking	11
4.2 Ambient conditions	11
4.2.1 Operation site	11
4.2.2 Ambient temperature	11
4.2.3 Space requirements	12
4.3 Power supply	12

4.4	Computer control	13
4.4.1	Setting up LAN	13
4.4.2	Configuring LAN settings	13
4.4.3	Connecting devices with LAN	14
4.4.4	Configuring the router	14
4.4.5	Integrating LAN into the company network	15
4.4.6	Controlling several systems separately in LAN	15
4.5	Setting IP addresses via software	16
4.5.1	Mobile Control: Setting a static IP address	16
4.5.2	Mobile Control: Setting a dynamic IP address via device name	17
4.5.3	Mobile Control: Setting a dynamic IP address via device serial number	17
4.5.4	Firmware Wizard: Setting a static IP address	18
4.5.5	Firmware Wizard: Setting a dynamic IP address	19
4.6	Installing cartridge for eluent pre-tempering	20
4.6.1	Mounting column to precolumn tempering	20
4.7	Capillary guide	21
5.	Operation	22
5.1	Initial start-up	22
5.2	Switching on	22
5.3	Control with chromatography software	22
6.	Functionality tests	23
6.1	Installation Qualification (IQ)	23
6.2	Operation Qualification (OQ)	23
7.	Troubleshooting	24
7.1	LAN	24
7.2	Possible problems and solutions	25
7.3	Error messages	25
7.4	Replacing fuses	26
8.	Maintenance and care	27
8.1	Maintenance contract	27
8.2	Cleaning and caring for the device	27
8.3	Removing a leak	27
8.4	Testing the leak sensor	28
9.	Transport and storage	29
9.1	Taking the device out of operation	29
9.2	Packing the device	29
9.3	Transporting the device	29
9.4	Storing the device	29
10.	Disposal	30
10.1	AVV-Marking Germany	30
10.2	WEEE registration number	30
10.3	Eluents and other operating materials	30

11. Technical data	31
11.1 Main features.....	31
11.2 Communication	31
11.3 General	31
12. Repeat orders	32
12.1 Device	32
12.2 Accessories and spare parts.....	32
13. Index	33

1. General

1.1 About these instructions

These operating instructions enable the safe and efficient operation of the device. The user must have carefully read and understood these operating instructions before starting any work.





The basic prerequisite for safe operation is compliance with all safety instructions (see „2 Basic safety instructions“, p. 3). In addition to the safety and warning instructions in these operating instructions, the local accident prevention regulations and the national industrial safety regulations apply.

These operating instructions are an integral part of the device. It must be kept in the immediate vicinity of the device and accessible to the user at all times.

You can download these and other instructions from the KNAUER website: www.knauer.net/library

1.2 Signal words

Possible dangers related to the device are distinguished in personal and material damages.

Symbol	Meaning
	DANGER (red) indicates a highly hazardous situation. If not avoided, it will result in death or serious injury.
	WARNING (orange) indicates a hazardous situation. If not avoided, it could result in death or serious injury.
	CAUTION (yellow) indicates a moderate hazardous situation. If not avoided, it could result in minor or moderate injury.
	NOTICE (blue) is used to address issues which are not related to physical injury.

1.3 Additional typographical conventions

- General equal treatment: When persons are described, this document uses the male grammar form to keep the text easy to read. The form has a neutral sense and speaks to people of any gender in the same way.
- Note: Specific information are prefixed with the word "Note" and an information icon.



Note: This is an example.

1.4 Legal information

1.4.1 Liability limitation

The manufacturer is not liable for the following issues:

- Non-compliance of these instructions
- Non-observance of necessary safety precautions
- Improper use
- Operation of the device by unqualified personnel (see „2.2 User qualification“, p. 3)
- Use of non-approved spare parts
- Technical changes by the user such as opening the device and unauthorized modifications
- Violations of General Terms and Conditions (GTC)

1.4.2 Transport damage

The packaging of our devices provides the best possible protection against transport damage. However, check the packaging for transport damage. In case you notice any damage, inform the Technical Support and the shipping company within three workdays.

1.4.3 Warranty conditions

For information on warranty please refer to our general terms and conditions on the website: www.knauer.net/terms

1.4.4 Declaration of conformity

The declaration of conformity is enclosed as a separate document with the product and can be obtained online:

www.knauer.net/en/Support/Declarations-of-conformity

2. Basic safety instructions

The device has been developed and constructed in such a way that hazards arising from its intended use are largely excluded. Nevertheless, the following safety instructions must be observed in order to exclude residual hazards.

2.1 Intended use

Only use the device for applications that fall within the range of the intended use. Otherwise, the protective and safety equipment of the device could fail.

2.1.1 Operating ranges

The device is intended to be used for chromatographic applications in the laboratory.

2.1.2 Foreseeable misuse

Refrain from the use of the device for the following purposes or conditions:

- Medical purposes. The device is not approved as a medical product.
- Operating outside of a laboratory or measurement room. Otherwise, the manufacturer does not guarantee the functionality and safety of the device.
- Operation in potentially explosive areas without special and additional explosion protection. Contact the KNAUER Customer Support for more information.

2.2 User qualification

The user is qualified to handle the device if all of the following points apply:

- He has at least a basic knowledge of liquid chromatography.
- He has knowledge about the properties of the used solvents and their health risks.
- He is trained for the special tasks and activities in the laboratory and knows the relevant standards and regulations.
- Due to his technical training and experience, he can understand and carry out all the work described in the operating instructions on the instrument and recognize and avoid possible dangers independently.
- His ability to react is not impaired by the consumption of drugs, alcohol or medication.
- Participation in the installation of a device or a training by the company KNAUER or an authorized company.

If the user does not meet these qualifications, he must inform his supervisor.

2.3 Operator responsibility

The operator is any person who operates the device himself or leaves it to a third party for use and who bears the legal product responsibility for the protection of the user or third parties during operation.

The obligations of the operator are listed below:

- Know and follow the applicable work safety regulations.
- Identify hazards arising from the working conditions at the place of use in a risk assessment.
- Set up operating instructions for the operation of the device.
- Regularly check whether the operating instructions correspond to the current status of the regulations.
- Clearly regulate and specify responsibilities for installation, operation, troubleshooting, maintenance and cleaning and set clear rules.
- Ensure that all personnel who work with the device have read and understood these operating instructions.
- Train the personnel who work with the device at regular intervals and inform them about the dangers.
- Provide the necessary safety equipment to the employees working with the unit (see section below).

2.4 Personal safety equipment

The protective measures required in the laboratory must be observed and the following protective clothing worn during all work on the device:

- Safety glasses with side protection.
- Protective gloves in accordance with the prevailing ambient conditions and used solvents (e.g. heat, cold, protection against chemicals).
- Lab coat.
- Personalised protective safety equipment which is specified in the particular laboratory.

2.5 Safety features on the device

- Power switch: Devices of the AZURA® L series may be switched off using the power switch (toggle switch on the back side of housing) at any time, this causes no damage to the device. To switch off devices of the AZURA® S series, remove the plug from the power socket.
- Front cover as a splash protection for the user.
- Leak tray: Devices of the AZURA® L series have a leak tray on the front side. The leak tray collects leaking solvents and protects components from potential damage caused by discharging liquid.
- For the detectors AZURA DAD 2.1L, DAD 6.1L und MWD 2.1L, the lamp switches off automatically when the cover is opened.

2.6 Working with solvents

2.6.1 General requirements

- The user is trained for handling different solvents.
- Note that organic solvents are toxic above a certain concentration. For handling hazardous solvents see the following section.
- Mobile phases and samples may contain volatile or combustible solvents. Avoid the accumulation of these substances. Ensure good ventilation of the installation site. Avoid open flames and sparks. Do not operate the instrument in the presence of flammable gases or vapors.
- Only use solvents which do not self-ignite under given conditions. This applies especially to the use of a thermostat where liquids could get onto hot surfaces in the interior.
- Certain chemicals can cause PEEK capillaries to swell or burst. Please read the technical literature on chemical compatibility of PEEK before use.

2.6.2 Contamination by health-threatening solvents

- Contamination with toxic, infectious or radioactive substances poses a hazard for all persons involved during operation, repair, sale, and disposal of a device.
- All contaminated devices must be properly decontaminated by a specialist company or the operating company before they can be recommissioned, repaired, sold, or disposed (see „10 Disposal“, p. 29).

2.6.3 Avoiding leakage

Risk of electrical shock or short circuit if solvents or other liquids leak into the interior of the device. You can avoid a leakage through the following measures:

- Tightness: Visually check the device or system regularly for leaks.
- Solvent tray: The use of a solvent tray prevents liquids get from the bottles into the inside of the device.
- Eluent lines: Install capillaries and hoses in such a way that, in case of a leak, liquids cannot get into the interior of the devices underneath.
- In case of leakage: Switch off the system. Only take the device into operation if the cause of the leak has been resolved (see „8 Maintenance and care“, p. 26).

2.7 Specific environments

2.7.1 Earthquake-endangered areas

In earthquake-endangered areas, do not stack more than 3 devices on top of each other. Otherwise there is risk of injury due to falling devices or loose parts.

2.7.2 Explosive environment

Never use the system in potentially explosive environments without appropriate protective equipment. For more information, contact the KNAUER Customer Support.

2.7.3 Cooling room



Note: When the AZURA® CT 2.1 is operated in a cooling room, deviations from the specifications of the heating/cooling rate, temperature accuracy and temperature stability are possible (see „11 Technical data“, p. 31).

You may operate the device in a cooling room. To prevent condensation, note the following instructions:

- Allow the device to acclimatize for min. 3 hours before taking it into operation.
- After taking into operation, the device should stay switched on.
- Avoid temperature fluctuations.

2.7.4 Wet room

The device must not be operated in wet rooms.

2.8 Maintenance, care, and repair

- Avoiding electric shock: Before performing any maintenance and service work, disconnect the device from the power supply.
- Tools: Use only tools recommended or prescribed by the manufacturer.
- Spare parts and accessories: Only use original parts and accessories made by KNAUER or a company authorized by KNAUER.
- PEEK fittings: Use PEEK fittings only for a single port or brand-new PEEK fittings in order to avoid dead volume or not exactly fitting connections.
- Column care: Follow KNAUER or other manufacturer's instructions on caring for the columns (see www.knauer.net/columncare)
- Used capillaries: Do not use any used capillaries elsewhere in the system in order to avoid dead volumes, not exactly fitting connections and spreading contamination.
- Safety features: The device may only be opened by the KNAUER Customer Support of KNAUER or any company authorized by KNAUER (see „1.4.1 Liability limitation“, p. 2).
- For more information visit the KNAUER website: www.knauer.net/hplc-troubleshooting.

2.9 Service request form

Devices which are shipped without the completed document “Service request form and decontamination report” will not be repaired. If you would like to return a device to KNAUER, make sure to enclose the completed document: www.knauer.net/servicerequest.

3. Product information

3.1 General

The AZURA® Column Thermostat CT 2.1 can be used in the following configurations:

- Up to 8 columns of dimensions 125 mm x 4.6 mm ID with precolumn
- Up to 4 columns of dimensions 300 x 4.6 mm ID
- 1 column of dimensions 300 mm x 16 mm ID.

A constant temperature between 5-85°C can be selected.

3.1.1 Optional accessories

The following optional accessory is available:

- Element for eluent pre-tempering to ensure that the mobile phase is on the set temperature before entry into the column.

3.1.2 GLP data

With the help of various software packages (e.g. ClarityChrom® or OpenLAB®), it is possible to display or read the GLP data of the thermostat. You find a detailed description on how to read out GLP data in the respective user instructions.

3.2 Scope of delivery

In the scope of supply of the device should these items be included:

- Device AZURA® Column Thermostat CT 2.1
- Power supply cable
- Network cable

Valid documents:

- Operating Instructions
- Installation Qualification ("IQ")
- Declaration of Conformity

3.3 Views

Front view

Legend

- ① Cartridge for eluent pre-tempering (optional)
- ② Door
- ③ Housing
- ④ Column holder
- ⑤ Fan
- ⑥ Temperature sensor
- ⑦ Column (not included in the scope of delivery)
- ⑧ Leak sensor

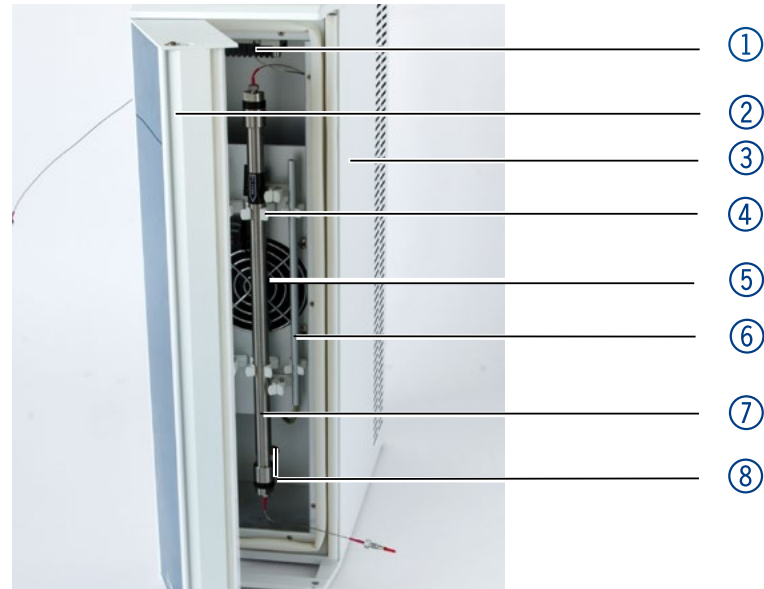

Fig. 1: Front view

Rear view



Note: Please note that the RS-232 interface ("service interface") is solely used for repair and maintenance tasks performed by service technicians.

Legend

- ① Service interface
- ② LAN connector
- ① Serial number and symbols (see chap. 3.4 on p. 9)
- ② Fan
- ③ Power switch
- ④ Fuse holder
- ⑤ Power supply connection socket

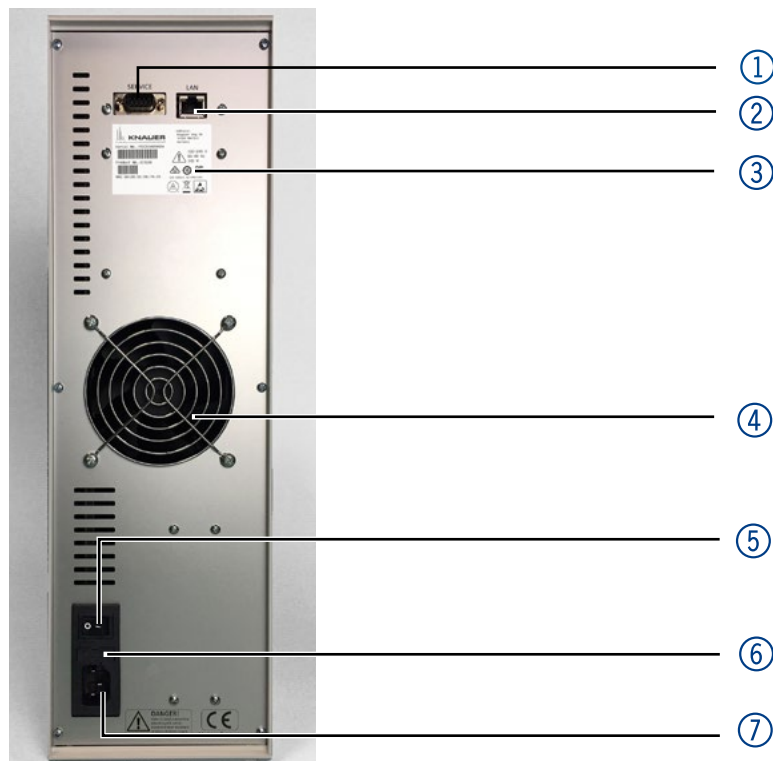











Fig. 2: Rear view

3.4 Symbols and signs

The following symbols and signs can be found on the device:

Symbol	Meaning
	Electric shock hazard. Failure to observe this warning may result in loss of life, serious injury or damage or destruction of the device.
	Electrostatic discharge hazard. Damages to system, device, or sensitive electronic components can occur.
	Danger from hot surface. If not observed, burns may result.
	A warranty seal is affixed to some devices.
	The device is covered by the Waste Electrical and Electronic Equipment Directive (WEEE Directive). It may not be disposed of as unsorted municipal waste and must be collected separately (see chap. 10 on p. 30).
	The device fulfills the product specific requirements of European directives.
	The device has successfully passed the TÜV tests for quality and safety. The TÜV Germany is a nationally recognized testing agency (NRTL) in Canada and the USA.
	The electromagnetic interference from the device is below the limits approved by the Federal Communications Commission (FCC).
	The device complies with the Australian EMV regulations.
CAN ICES-3 (B)	The device complies with Industry Canada license-exempt RSS standards.

Symbol **Meaning**



The device can be used for 15 years according to its intended use before there is a risk that the contained substances may escape and thereby pose a risk to the environment and health.

部件名称	有毒及危险物质或元素					
	铅	汞	镉	铬(VI)	多溴联苯	多溴二苯醚
印刷电路板	O	O	O	O	O	O
机电部件	O	O	O	O	O	O
电缆和电线	O	O	O	O	O	O
金属部件	X	O	O	O	O	O
塑料部件	O	O	O	O	O	O
电池	O	O	O	O	O	O
显示	n/a	n/a	n/a	n/a	n/a	n/a

O = 表示部件中所有同质金属中的有毒和危险物质含量低于SJ/T 11363-2006中描述的浓度极限要求。(表示部件中所有同质金属中的有毒和危险物质含量低于SJ/T 11363-2006中描述的浓度极限要求。*)

X = 表示部件中所有同质金属中的有毒和危险物质含量超过SJ/T 11363-2006中描述的浓度极限要求。(表示部件中所有同质金属中的有毒和危险物质含量超过SJ/T 11363-2006*中描述的浓度极限要求。*)

Part Name	toxic and hazardous substances or elements					
	Pb	Hg	Cd	Cr(VI)	PBB	PBDE
PCB	O	O	O	O	O	O
Electromechanical parts	O	O	O	O	O	O
Cables & wires	O	O	O	O	O	O
Metal Parts	X	O	O	O	O	O
Plastic parts	O	O	O	O	O	O
Batteries	O	O	O	O	O	O
Display	n/a	n/a	n/a	n/a	n/a	n/a

O = Indicates that the content of the toxic and hazardous substances in all homogenous Materials of the part is below the concentration limit requirements as described in SJ/T 11363-2006. (Indicates that the content of the toxic and hazardous substances in all homogenous Materials of the part is below the concentration limit requirements as described in SJ/T 11363-2006.*)

X = Indicates that the content of the toxic and hazardous substances in all homogenous Materials of the part is exceeds the concentration limit requirements as described in SJ/T 11363-2006. (Indicates that the content of the toxic and hazardous substances in all homogenous Materials of the part is exceeds the concentration limit requirements as described in SJ/T 11363-2006.*)

4. Installation and initial startup

Before you determine the operation site, read the chapter "Technical Data" (see chapter 11 on page 30). There you will find all device-specific information on power supply, ambient conditions and humidity.



Note: The intended use be ensured only if the requirements for ambient conditions of the operating environment are met.

4.1 Unpacking

Process

Procedure

1. Place the packaging in such a way that the lettering on the label is in the correct position.
2. Check the packaging, the device and the accessories for transport damage.
3. Check the scope of delivery. In the event of incomplete delivery, contact Technical Support immediately.

Next steps

- Keep the included packing list for repeat orders.
- Keep the original packaging for safe storage or transportation.

4.2 Ambient conditions

4.2.1 Operation site

Observe the following requirements for the operation site so that the measurement results are not influenced:

- Place on a firm, level and straight surface.
- Protect against direct sunlight.
- Do not expose to air drafts such as air conditioning systems.
- Do not set up the to other machines that cause floor vibrations.
- Keep from high frequency sources.
- Ensure adequate ventilation (see 4.2.3 on page12).
- Avoid temperature fluctuations. (see 4.2.2 on page11)

4.2.2 Ambient temperature

If the ambient temperature of the device is abruptly changed (e.g. when it is installed in a cooling chamber), condensation will form inside the device and may cause damage to the device. Allow the device to acclimate for 3 h, before it is connected to the power supply and taken into operation.

4.2.3 Space requirements

- Make sure that the power plug on the power supply (wall socket or power strip) is always accessible, so that the device can be disconnected from the power supply.
- Ensure adequate ventilation around the device, otherwise it may overheat and malfunction:
 - Min. 5 cm distance if another device is set on one side.
 - Min. 10 cm distance if further devices are set on both sides.
 - At least 15 cm to the cooler fan on the rear.

4.3 Power supply

Power supply requirements

- Failure-free power supply: For failure-free operation, the electrical voltage must be free of fluctuations, residual currents, voltage peaks and electromagnetic interference. The device must receive sufficient voltage and reserve capacity.
- Check voltage: Only connect devices to a power supply whose voltage corresponds to the permissible voltage of the device.
- Power consumption: The nominal power of the connected devices must not exceed 50 % of the highest connected power capacity, since higher currents can flow briefly when the device is switched on.
- Main connection: The electrical power supply at the operation site must be connected directly to the nearest main power connection.
- Grounding: The connectors for the voltage must be grounded accordingly.

Power supply cables and plugs

- Original parts: For power supply, use the supplied power cable and plug to meet the specifications which are described in the chapter "Technical Data" (see chapter 11 on page 30). Detachable power cable cables are not allowed to be replaced with other cable types.
- Country-specific plugs: Before switching on the device, check whether the supplied plug is approved for your country. Overview of the device- and country-specific plug types from KNAUER: www.knauer.net/plugs
- Power strips: If several devices are connected to one power strip, always consider the maximum power consumption of each device.
- Access to power supply: Make sure that the power plug on the power supply (wall socket or power strip) is always accessible, so that the device can be disconnected easily from the power supply.
- Damaged power supply cables and plugs: For safety reasons, damaged or faulty cables and plugs must not be used to connect the device to the power supply. Replace defective cables and plugs only with KNAUER accessories.

4.4 Computer control



Note: HPLC devices from KNAUER only work with IP addresses, which have been assigned by IPv4. IPv6 is not supported.

This chapter describes how to set up a chromatography system in a local area network (LAN) and how a network administrator can integrate this LAN into your company network. The description applies to the operating system Windows® and all conventional routers.



Note: When using PurityChrom®, static IP addresses are needed (see chapter 4.4 on page 13).

4.4.1 Setting up LAN

To set up a LAN, we recommend to use a router. That means the following steps are required:

	Process
Procedure	1. On the computer, go to the control panel and check the LAN properties.
	2. Hook up the router to the devices and the computer.
	3. Set up the router for the computer network.
	4. Install the chromatography software.
	5. Switch on the device and run the chromatography software.
Next steps	Configure LAN properties (see section 4.4.2).

4.4.2 Configuring LAN settings

The LAN uses only one server (which is normally the router) from that the devices automatically receive their IP address.

Prerequisites	<ul style="list-style-type: none"> ■ In Windows, power saving, hibernation, standby, and screen saver must be deactivated. ■ Applies to all LAN devices: Disable the setting for the network adapter in Device Manager "Allow the computer to turn off this device to save power".
----------------------	--

	Process
Procedure	1. In Windows, open <Network and Sharing Center>.
	2. Double-click on <LAN connection>.
	3. Click on the button <Properties>.
	4. Select <Internet Protocol version 4 (TCP/IPv4)>.
	5. Click on the button <Properties>.
	6. Check the settings in the tab <General>. The correct settings for the DHCP client are: <ol style="list-style-type: none"> a) Obtain an IP address automatically b) Obtain DNS server address automatically

Process

- Click on the button <OK>.

Next steps Connect devices (see section 4.4.3).

4.4.3 Connecting devices with LAN

A router ② has several LAN ports ③ and one WAN port ④ that can be used to integrate the LAN into a wide area network (WAN), e.g. a company network or the Internet. In contrast, the LAN ports serve to set up a network from devices ① and a computer ⑤. To avoid interference, we recommend operating the chromatography system separately from the company network.



Note: You will find patch cables for each device and the router in the accessories kit. To connect the router to a LAN, an additional patch cable is required, which is not supplied within the scope of delivery.

- ① Devices
- ② Router
- ③ LAN ports
- ④ WAN/Internet connection
- ⑤ Computer

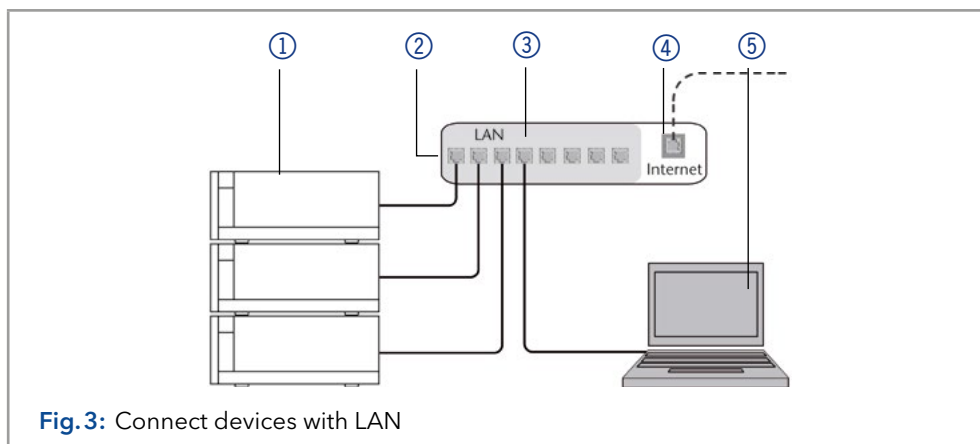
**Prerequisites**

- The computer is switched off.
- There is a patch cable for each device and the computer.

Process**Procedure**

- Use the patch cable to connect the router and the computer. Repeat this step to connect all devices.
- With additional patch cables, connect all devices individually with the router.
- Use the power supply to connect the router to the mains power system.

Next steps Set the router properties (see section 4.4.4).

4.4.4 Configuring the router

The router is preset at the factory. Information about address, user name and password is noted in the router manual: www.knauer.net/router

	Process
Procedure	1. To open the router configuration, start your Internet browser and enter the IP address (does not apply for all routers).
	2. Enter user name and password.
	3. Configure the router as DHCP server.
	4. In the router configuration, check the IP address range and make changes if necessary.



Note: If the IP address range has been changed, it is essential to note this information on the router.

Result Once the router has assigned IP addresses to all devices, the chromatography software can be used to remotely control the system.

4.4.5 Integrating LAN into the company network

A network administrator can integrate the LAN into your company network. In this case you use the WAN port of the router.

Prerequisites

- There is a patch cable for the connection.

	Process
Procedure	1. Make sure that there is no overlap between the IP addresses of the router and the corporate network.
	2. In case of an overlap, change the IP address range of the router.
	3. Use the patch cable to connect the router WAN port to the company network.
	4. Restart all devices, including the computer.

Result The LAN is now integrated into the company network.

4.4.6 Controlling several systems separately in LAN

Devices connected to a LAN communicate through ports, which are part of the IP address. If more than one chromatography systems are connected to the same LAN and you plan on controlling them separately, you can use different ports to avoid interference. Therefore, the port number for each device must be changed and this same number must be entered into the device configuration of the chromatography software. We recommend to use the same port number for all devices in the same system.



Note: The port is set to 10001 at the factory. You must use the same numbers in the device configuration of the chromatography software as in the device, otherwise the connection fails.

	Process
Procedure	1. Find out port number and change it on the device.
	2. Enter the port number in the chromatography software.

Result The connection is established.

4.5 Setting IP addresses via software



Note: Check the IT security standards for your lab before intervening in the LAN settings.

PurityChrom® Static IP addresses are required to run certain chromatography software, e.g. Purity Chrom®. For a comprehensive overview on how to set static IP addresses for PurityChrom®, refer to the document „PurityChrom® Installation Guide“ on the PurityChrom® installation CD.

For Mobile Control and Firmware Wizard, it is possible to set a fixed (static) or dynamic (DHCP) IP address via software.

4.5.1 Mobile Control: Setting a static IP address



Note: The device is preset to a dynamic address (DHCP). To ensure a constant LAN connection between the chromatography software and the instrument, we recommend switching the instrument to a static IP address for certain applications. More information about LAN settings can be found in the Mobile Control Software Instructions in the chapter "Device Settings" (document no. V6851).

Prerequisites

- The device is switched on.
- Mobile Control is installed and running.
- The connection between Mobile Control and the device has been established.

Process

Procedure

1. In Mobile Control, click <Settings>.
2. On the <General> tab, choose the device name.
3. In <Network Settings>, choose the setting <Static> ①.
4. Enter the IP address into the text box <IP Address> ②.
5. If necessary, change the subnet mask and the gateway ③.
6. Click in the top right corner.
7. Restart the device (recommended).

- ① IP address mode
- ② Text box for IP address
- ③ Text field for subnet mask/gateway

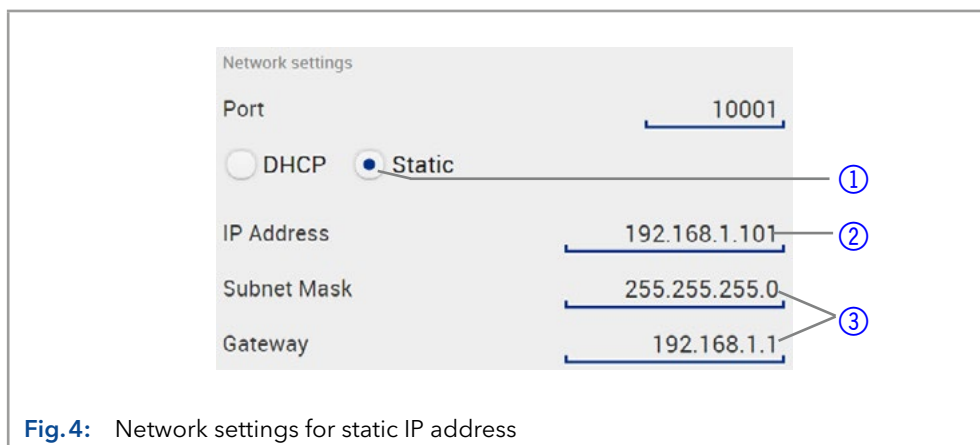





Fig.4: Network settings for static IP address

Result The device is now accessible via the static IP address.

4.5.2 Mobile Control: Setting a dynamic IP address via device name

- Prerequisites**
- The device is switched on.
 - Mobile Control is installed and running.
 - The connection between Mobile Control and the device has been established.

Process

- Procedure**
1. In Mobile Control, click  <Settings>.
 2. On the <General> tab, choose the device.
 3. In <Network Settings>, choose the setting <DHCP> .
 4. Click  in the top right corner.
 5. Restart the device (recommended).

 IP address mode

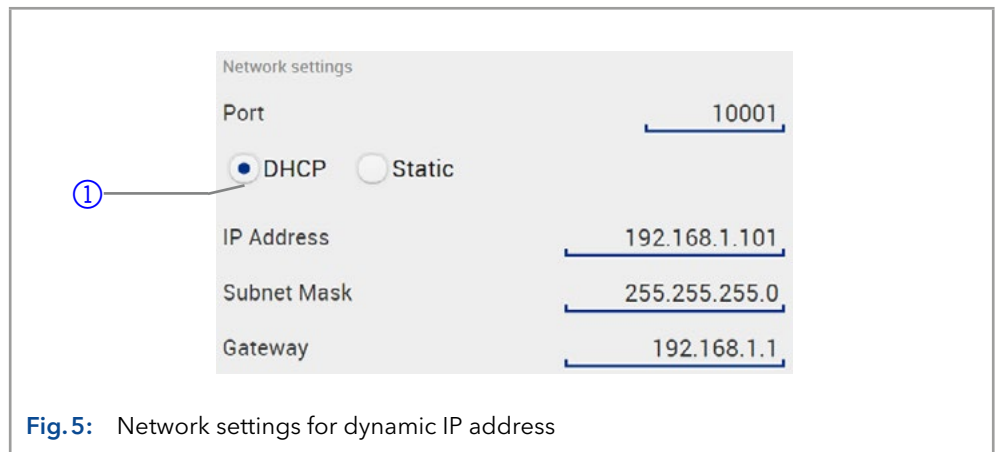

Result The device is now accessible via a dynamic IP address.

4.5.3 Mobile Control: Setting a dynamic IP address via device serial number

- Prerequisites**
- The device is switched on.
 - Mobile Control is installed and running.
 - The connection between Mobile Control and the device has been established.

Process

- Procedure**
1. In Mobile Control, click  <Settings>.
 2. In <Network Settings>, click <Reset>. The windows <Reset communication settings> opens.
 3. Enter the serial number of the device into the text field.
 4. Click <OK>. The device is now reset to default settings.
 5. Restart the device (recommended).

Result The device is now accessible via a dynamic IP address.

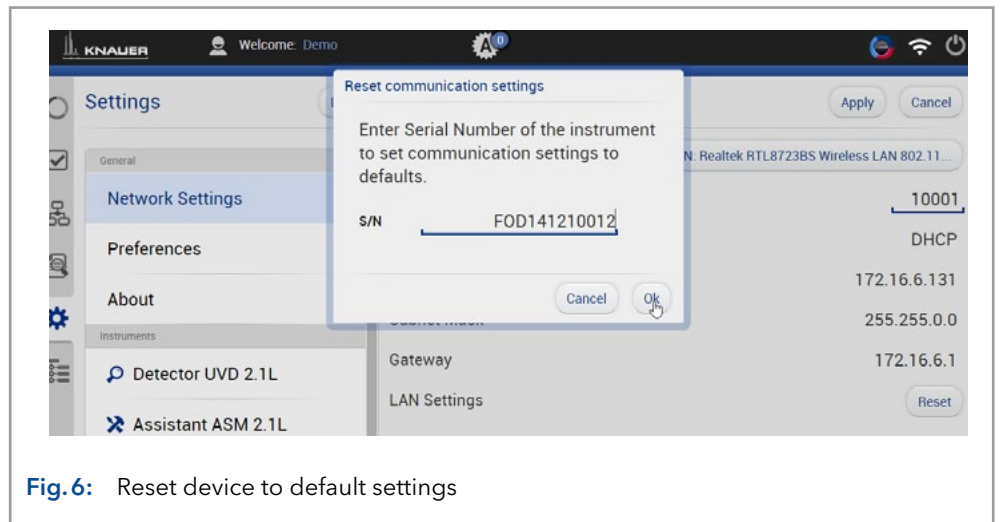

Fig. 6: Reset device to default settings

4.5.4 Firmware Wizard: Setting a static IP address



Note: More information about LAN settings can be found in the Mobile Control Software Instructions in the chapter "Firmware Wizard" (document no. V6851).

- ① Text box for serial number of the device
- ② Setting IP address manually
- ③ Text box for IP address
- ④ Text box for subnet mask & gateway
- ⑤ Confirm changes

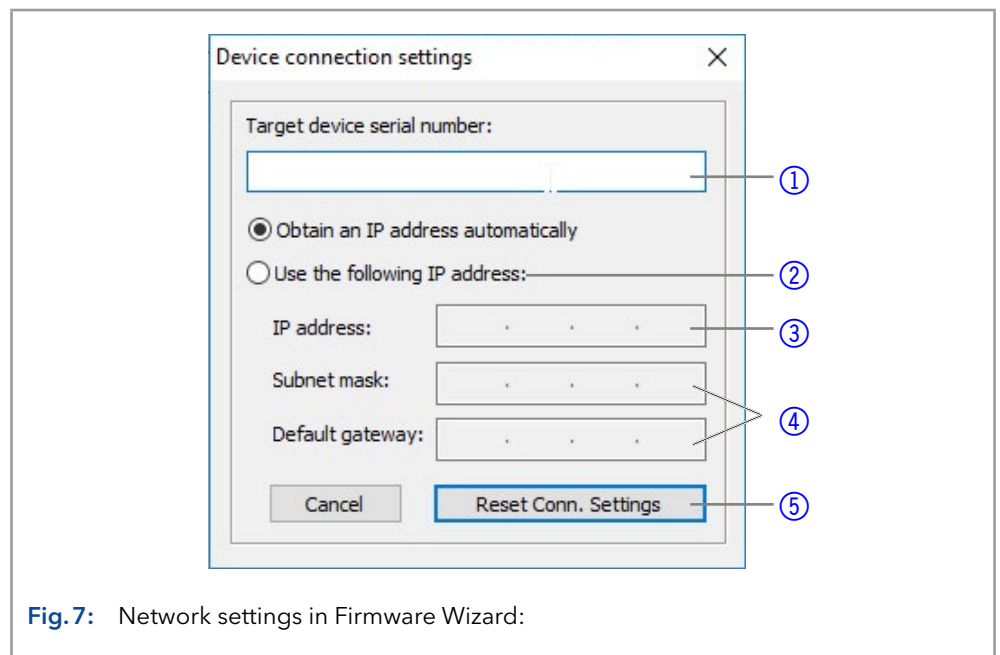

Fig. 7: Network settings in Firmware Wizard:

Prerequisites

- The device is switched on.
- Firmware Wizard is installed and running.
- The connection between Firmware Wizard and the device has been established.

Process

Procedure

1. In Firmware Wizard, click <Reset LAN Settings...>.
2. The window <Device connection settings> opens. Enter serial number of the device into the text field <Target device serial number> ①.
3. Select option <Use the following IP address> ②.

Process

4. Enter the IP address into the text field <IP address> ③ .
5. Optionally, adjust subnet mask and gateway ④ .
6. Click <Reset Conn. Settings> ⑤ to accept changes.
7. Restart the device (recommended).

Result The device is now accessible via the static IP address.

4.5.5 Firmware Wizard: Setting a dynamic IP address

Prerequisites

- The device is switched on.
- Firmware Wizard is installed and running.

Process**Procedure**

1. In Firmware Wizard, click <Reset LAN Settings...>.
2. The window <Device connection settings> opens. Enter MAC address of the device into the text field <Target device serial number> ① .
3. Select option <Obtain an IP address automatically> ② .
4. Click <Reset Conn. Settings> ⑤ to accept changes.
5. Restart the device (recommended).

Result The device is now accessible via a dynamic IP address.

4.6 Installing cartridge for eluent pre-tempering

A cartridge can be purchased as an option for the eluent pre-temper. The cartridge allows you to control the eluent tempering to the temperature of the thermostat before entering the column. This prevents a temperature gradient on the column and thus increases the reproducibility and separation efficiency.



Note: It is recommended to pre-temper the eluent to flow rates for more than 500 µl/min and temperatures above 50°C.

The cartridge for the pre-column tempering is mounted with two screws at the top in the thermostat interior.

- Prerequisites**
- The device is switched off.
 - Power plug is pulled.

Tools Allen screwdriver, size 2.5

Procedure

Process

1. Tighten the cartridge ① with two screws ②.
2. Connect one of the two capillaries of the precolumn tempering ③ to the autosampler or the manual injection valve.
3. Connect the column to the other capillary.

Figure

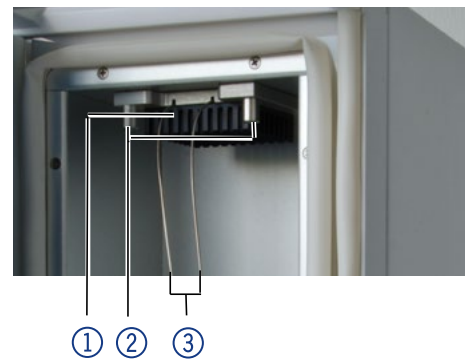

Fig. 8: Precolumn tempering

4.6.1 Mounting column to precolumn tempering

If no column selection valve is installed, the separation column is connected directly to the precolumn tempering.

⚠ WARNING

Hot surface

Danger of burns from 185 °F (85 °C) hot surfaces in the column compartment.

→ Wear protective gloves.



Note: Max. one separating column can be connected to the precolumn tempering.

4.7 Capillary guide

If a capillary is led up and out of the thermostat interior, make sure to use the provided cut-out. This is particularly to be observed with an installed cartridge for eluent pre-tempering.

The cut-out ensures that the capillary is not bent and damaged when closing the door. For the same reason, capillaries may not be led down and out of the interior of the CT 2.1.

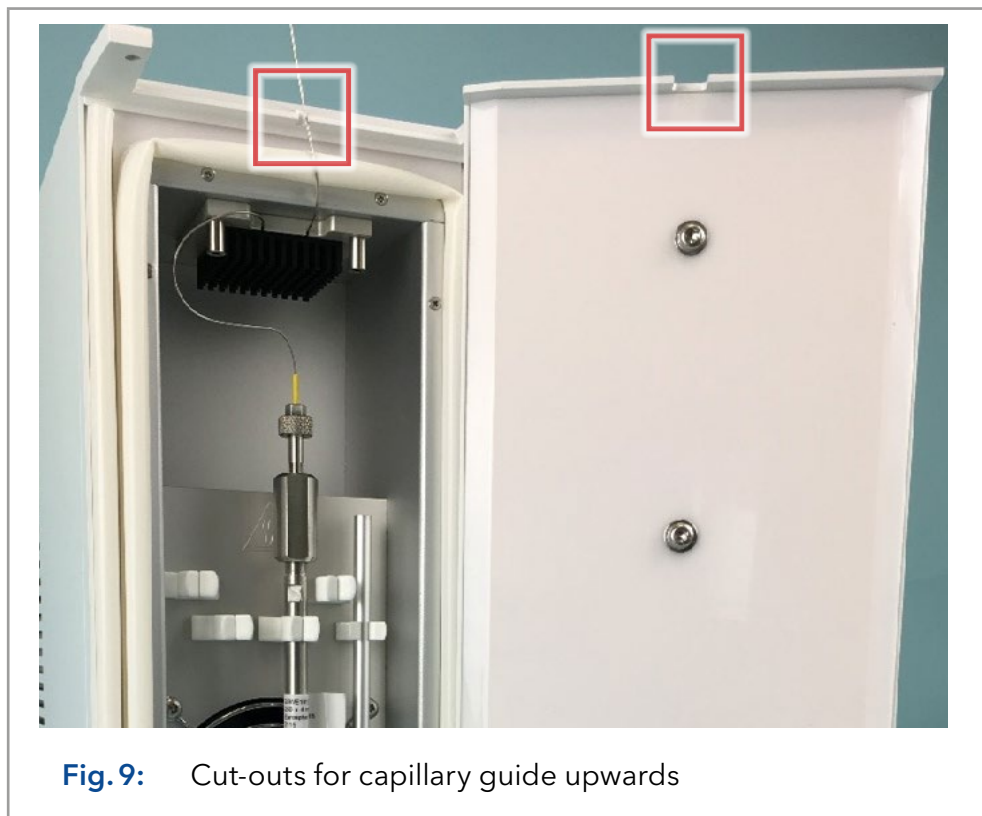

Note: When installing multiple columns, check the distribution of the column labels. Several labels directly in front of the fan can lead to a disturbance of air circulation.

5. Operation

5.1 Initial start-up

Use this checklist to determine whether the device is ready for initial start-up:

- Device is positioned in the correct location.
- The power plug has been connected.

If the device is part of a HPLC system, you should note the following:

- The network connection to the router is established
- The chromatography software has been installed by KNAUER or a company authorized by KNAUER.

5.2 Switching on

Prerequisites The installation has been completed.

WARNING

Burns

An overconcentration of organic solvents may lead to explosions.

→ Check the tightness of all fittings before using organic solvents.

NOTICE

Device defect

Changes of the environmental temperature cause condensation inside the device.

→ Allow device to acclimate for 3 h before connecting to power supply and taking into operation.

- Procedure**
1. Connect the power cable of the device to the power supply.
 2. Turn the power switch on.
 3. Set the desired temperature with the chromatography software or the control unit.

Standby When the thermostat is not in operation, the heating and cooling elements are switched off. After about 4-5 minutes, the fan in the interior will also be stopped after the operation. The power consumption is reduced to the external fan and the power supply of the controller.

5.3 Control with chromatography software

The device must be connected via LAN to a computer to control it with the software Chromeleon™, Purity Chrom® or Mobile Control.

A detailed description how to operate the chromatography software is found in the respective instructions.

6. Functionality tests



Note: Standard processes regarding IQ and OQ in single devices may be handled differently in individual cases.

6.1 Installation Qualification (IQ)

The customer may request the Installation Qualification, which is free of charge. In case of a request, the Technical Support of KNAUER or from a provider authorized by KNAUER performs this functionality test during the installation.

The Installation Qualification is a standardized document that includes the following:

- confirmation of flawless condition at delivery
- check if the delivery is complete
- certification on the functionality of the device

6.2 Operation Qualification (OQ)

The Operation Qualification includes an extensive functionality test according to KNAUER standard OQ documents. The Operation Qualification is a standardized document and free of charge. It is not part of the delivery. Please contact the Technical Support in case of request.

The Operation Qualification includes the following:

- definition of customer requirements and acceptance terms
- documentation on device specifications
- device functionality check at installation site

Test Intervals To make sure that the device operates within the specified range, you should test the device regularly. The test intervals depend on the usage of the device.

Execution The test can be carried out either by the Technical Support of KNAUER or from a provider authorized by KNAUER (for a fee).

7. Troubleshooting



Measures:

- Compare errors with error list “7.2 Possible problems and solutions” on page 25.
- Contact the Technical Support.

7.1 LAN

Go through the following steps, in case no connection between the computer and the devices can be established. Check after each step if the problem is solved. If the problem cannot be located, contact the Technical Support.

1. Check the status of the LAN connection in the Windows task bar:

-  Connected
-  Connection not established

If no connection was established, test the following:

- Is the router switched on?
 - Is the patch cable connected correctly to the router and the computer?
2. Check the router settings:
 - Is the router set to DHCP server?
 - Is the IP address range sufficient for all the connected devices?
 3. Check all connections:
 - Are the patch cable connected to the LAN ports and not the WAN port?
 - Are all cable connections between devices and router correct?
 - Are the cables plugged in tightly?
 4. If the router is integrated into a company network, pull out the patch cable from the WAN port.
 - Can the devices communicate with the computer, even though the router is disconnected from the company network?
 5. Turn off all devices, router, and computer. First switch on the router and wait until it has successfully completed its self-test. Firstly, turn on the router and secondly turn on the devices and the computer.
 6. Replace the patch cable of the device with that no connection could be established.
 7. Make sure that the IP port of the device matches the port in the chromatography software.

7.2 Possible problems and solutions

Error	Solution
Device cannot be switched on	Inspect the power cable to ensure that it is plugged into the power supply.
The alarm does not trigger in case of leakage	Check leak sensor settings.
The alarm is triggered, even though there is no visible leakage	<ul style="list-style-type: none"> ■ The leak sensor sensitivity is set too high. Check leak sensor settings. ■ After long periods of standing or transporting, aerate the CT 2.1 with a slightly opened door air.
The target temperature has not been reached	<ul style="list-style-type: none"> ■ Check if the door is fully closed ■ Check if the ventilation slots on the back and on the side are unblocked ■ Check if the fans inside and outside of the device are working ■ Set a longer plateau phase ■ Correct the temperature
System failure	Switch off the device to reset the memory. Restart.

7.3 Error messages

If an error occurs, you will hear a repetitive signal sound. If error messages are displayed which are not listed below, restart the device once. If a error messages are shown repeatedly, inform the Technical Support.

Error message	Measures
ERROR temp sensor	Device error during the self-test. Contact Technical Support.
T-LOCK ALARM	Temperature limit is reached. Check the selected value and change if necessary. If no error can be found in the settings, contact the Technical Support.
LEAKSENSOR ALARM	Solvent leaks. Check the connections of the column capillaries.
T-SENSOR ALARM	Device error. Contact Technical Support.
ERROR EEPROM	Device error. Contact Technical Support.

Next steps After elimination of the error, you can continue by pressing <ENTER>.

7.4 Replacing fuses

The device has a fuse holder on the rear of the device. It is located between the power on/off switch and socket for the power supply cable. The fuse holder contains a fuse for the operation and a spare fuse.

⚠ WARNING

Burns

Inserting an inappropriate fuse can pose a fire hazard.

→ Use only fuses of the same type and rating as the fuse to be replaced.

- Prerequisites**
- The device is switched off.
 - The power cable is disconnected from the socket of the device.
 - You have access to the rear of the device.

- Required materials**
- Small flat-head screwdriver

Process

1. Slide the head of the screwdriver from below behind the flap of the fuse holder ①. Carefully lever open the flap to the front. The fuse holder pops slightly out when the flap gets loose.
2. Pull the fuse holder out of the compartment and replace the defective fuse.
3. Put the fuse holder back into the compartment and close the flap. The fuse holder can only be inserted in its proper orientation.

Figure

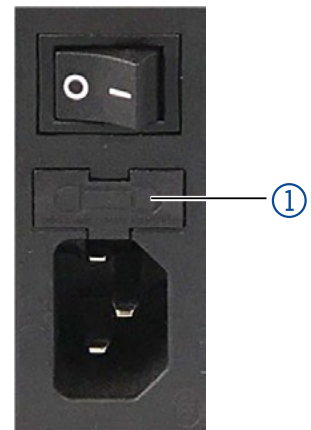

Fig. 10: Fuse holder

- Next steps**
- Afterwards, take the device into operation.

8. Maintenance and care

The maintenance of a device for the HPLC has a decisive impact on the success of analyzes and the reproducibility of results. If maintenance work is required which are not described here, contact your dealer or the Technical Support.

NOTICE

Electronic defect

Performing maintenance tasks on a switched on device can cause damage to the device.

- Switch off the device
- Pull the power plug.

8.1 Maintenance contract

The device may only be opened by the Technical Support of KNAUER or any company authorized by KNAUER. This maintenance work is covered by a separate maintenance contract.

8.2 Cleaning and caring for the device

NOTICE

Device defect

Intruding liquids can cause damage to the device.

- Place solvent bottles next to the device or in a solvent tray.
- Moisten the cleaning cloth only slightly.

All smooth surfaces of the device can be cleaned with a mild, commercially available cleaning solution, or with isopropanol.

8.3 Removing a leak

Auxiliary material Cloth

Procedure

Process

1. Remove the leak.
2. Dry the interior of the thermostat with the cloth.
3. Confirm the error message on the control panel or chromatography software.

Next Steps Afterwards, take the device into operation.

8.4 Testing the leak sensor

The functionality of the leak sensor should be checked once a year.
Perform the following test:

- Prerequisites**
- The device is switched on.
 - The device is standing vertically with the door closed.
 - The device runs at a temperature between 20-30°C.

- Required materials**
- Syringe
 - Methanol: 25 µl and 100 µl
 - Cellulose

Procedure

Process

1. Put the methanol with the syringe on a piece of cellulose.
2. Immediately place the cellulose into the interior of the thermostat.
3. Close the door.

- Test results**
- 25 µl methanol: No alarm is triggered
 - 100 µl methanol: Alarm is triggered



Note: Open the door between the two tests for a few minutes to evaporate the methanol of the first test.

Correction of the leak sensor

If this test does not bring the desired results, please contact the KNAUER Customer Support.

9. Transport and storage

Regarding the following information, carefully prepare the device for transport or storage.

9.1 Taking the device out of operation

Prerequisites The device is switched off.

Procedure

Process

1. Pull the power plug out of the socket and then out of the device.
2. Pack the power cable together with the device.

Next steps Disconnect all electrical connections. Remove the accessories and pack the device for transport or storage.

9.2 Packing the device

- Original packaging: Ideally you should use the original transport packaging.
- Lifting: Grab the device around the center of both sides and lift it into the packaging. Do not hold onto front cover or leak tray, as these parts are loosely attached to the device.

9.3 Transporting the device

- Documents: If you want to return your device to KNAUER for repairs, enclose the Service Request Form and Decontamination Report which can be downloaded from our website: www.knauer.net/servicerequest
- Device data: For a secure transport, note the weight and dimensions of the device (see chapter "11" on page 30).

9.4 Storing the device

- Flushing solution: Pay attention that all hoses and capillaries have been emptied or filled with flushing solution (e. g. isopropanol) before storage. To prevent algae formation, do not use pure water.
- Seals: Close all inputs and outputs with cap fittings.
- Ambient conditions: The device can be stored under ambient conditions which are listed in the Technical Data section (see chapter "11" on page 30).

10. Disposal

Hand in old devices or disassembled old components at a certified waste facility, where they will be disposed of properly.

10.1 AVV-Marking Germany

According to the German "Abfallverzeichnisverordnung" (AVV) (January, 2001), old devices manufactured by KNAUER are marked as waste electrical and electronic equipment: 160214.

10.2 WEEE registration number

KNAUER as a company is registered by the WEEE number DE 34642789 in the German "Elektroaltgeräteregister" (EAR). The number classifies to category 8 and 9, which, among others, comprises laboratory equipment.

All distributors and importers are responsible for the disposal of old devices, as defined by the WEEE directive. End-users can send their old devices manufactured by KNAUER back to the distributor, the importer, or the company free of charge, but would be charged for the disposal.

10.3 Eluents and other operating materials

All eluents and other operating materials must be collected separately and disposed of properly.

All wetter components of a device, e. g. flow cells of detectors or pump heads and pressure sensors for pumps, have to be flushed with isopropanol first and water afterwards before being maintained, disassembled or disposed.

11. Technical data

11.1 Main features

Thermostat	Temperature control	Microprocessor-controlled Peltier element for heating and cooling, fan-supported two-way air circulation
	Temperature range	5-85 °C
	Heating/cooling rate	2 °C/min
	Temperature precision	+/- 0.2°C
	Temperature stability	+/- 0.1 °C
Column compartment	Mobile phase pre-tempering	Passive temperature control with optional cartridge
	Number of columns	<ul style="list-style-type: none"> ■ Up to 8 columns (125 x 4.6 mm ID) with precolumn ■ Up to 4 columns (300 x 4.6 mm ID) ■ 1 column (300 x 16 mm ID)
	Column size	Analytical and preparative columns with up to 325 mm in length and 35 mm outer diameter (total external dimensions incl. union nuts)
	Dimensions of column compartment	90 x 390 x 47 mm (W x H x D)

11.2 Communication

Control	LAN
Programming	Temperature plateaus and gradients

11.3 General

Device	GLP	Via software: <ul style="list-style-type: none"> ■ Serial number ■ Firmware version ■ Date of installation ■ Date of last maintenance ■ Mainboard run time
	Safety	Self-test and auto calibration when switching on; adjustable switch-off temperature
	Leak sensor	Gas sensor with adjustable sensitivity and acoustic signal

Device	Protection type	IP-20
	Dimensions	150 x 470 x 310 mm (Width x Height x Depth)
	Weight	8.4 kg
Power supply	Power input	100-240 V
	Output	50-60 Hz
	Max. power consumption	100 Watt
Permitted operating environment	Recommended ambient temperature	17-28 °C (62.6-82.4 °F)
	Area of use	For indoor use only
	Line voltage fluctuations do not exceed $\pm 10\%$ of normal voltage.	
	Permitted pollution degree	2
	Air humidity	below 90 %, non-condensing
	Max. operating altitude	2000 meters above sea level

12. Repeat orders

The list of repeat orders is up-to-date at the time of publication. Deviations are possible at later points in time.

Use the included packing list for repeat orders of spare parts. If there are any questions concerning repeat orders, contact the Technical Support.

Further information Further information on spare parts and accessories can be found online: www.knauer.net.

12.1 Device

Name	Order number
AZURA® Column Thermostat CT 2.1	ATC00

12.2 Accessories and spare parts

Name	Order number
Cartridge 0.18 mm capillary ID	A05852-2
Cartridge 0.10 mm capillary ID	A05852-3
Network cable	A5255

13. Index

A

Accessories 32
 Optional 7
Ambient conditions 11, 29
Ambient temperature 11
AVV-marking 30

C

Column compartment 31
Company network 15, 24
Control
 software 22

D

Decontamination Report 29
Dimensions 32
Disposal 30

E

Error messages 25

F

Firmware Wizard
 Setting IP addresses 18-19
Flushing solution 29

G

GLP 31

I

Initial startup 11
Installation 11
Installation Qualification (IQ) 23
IP address
 setting 16-19

L

LAN
 connect 13-15
 Troubleshooting 24
Leaks
 removing 27
Leak sensor 28, 31

M

Maintenance 27
Maintenance contract 27
Mobile Control
 Setting IP addresses 16-18

O

Old devices 30
Operating Environment 32
Operation 22

Operation Qualification (OQ) 23
Operation site 11
Original packaging 29

P

Power supply 12, 32
Precolumn tempering
 Element 7
 Install column 20
 Installing cartridge 20
Product information 7
protection type 32

R

Repeat orders 32
Router 14, 24

S

Scope of delivery 7
Service request form 29
Software 22
Solvent
 Disposal 30
Space requirement 12
Start-up 22
Storage 29
Switch on 22

T

Taking out of operation 29
Temperature control 31
Transport 29

U

Unpacking 11

V

Views 8

W

WEEE Registration Number 30
Weight 29, 32

Science Together



Latest KNAUER instructions online:
www.knauer.net/library

KNAUER
Wissenschaftliche Geräte GmbH
Hegauer Weg 38
14163 Berlin

Phone: +49 30 809727-0
Fax: +49 30 8015010
E-Mail: info@knauer.net
Internet: www.knauer.net