

# Applications

Collection of solutions by KNAUER



Analytical/Preparative HPLC • FPLC • SMB • Osmometry • Sample preparation

## KNAUER Applications



### Bio sciences

The scope of these applications covers a wide area of bio and life sciences tasks. Biomolecules like proteins, peptides and nucleotides are analyzed by HPLC or UHPLC for their purity and /or concentration. Another application focus is the purification of proteins in a native usable condition. These applications are also referred to as FPLC.



### Chemical analysis

For applications in the field of chemical analysis, various separation mechanisms are used. Depending on the properties of the substances and the challenge of the separation, gel permeation chromatography, ion pair chromatography, reversed phase, or chiral is used in the separation mode."



### Environmental

Environmental applications cover a wide range of application areas. Prior pollutants, pesticides or PAH's are determined with different HPLC techniques from analytical up to preparative.



### Food, feed and beverages

Working with innovative technologies we develop separation and analytical methods, for example determination of mycotoxins in food and feed, separation of additives in soft drinks or determination of osmolality of isotonic and non-isotonic beverages.



### Pharmaceutical

In pharmaceutical industry, HPLC plays an important and critical role in the analysis of compounds. It is used in quality control to test compounds for purity and to perform qualitative and quantitative analysis. Another important field is pharmaceutical research and development where target molecules are identified and analyzed by chromatography.



### Special applications

Special applications emphasize special features of KNAUER products or other topics with a more technical focal point.

# KNAUER Applications

## Table of Contents

### Bio sciences

<b>VBS0063</b>	Automated two step purification of mouse antibody IgG1 .....	<b>1</b>
<b>VBS0064</b>	Comparison of IgG purification with two different protein A media .....	<b>5</b>
<b>VBS0066</b>	Fast and sensitive size exclusion chromatography of IgG antibody .....	<b>9</b>
<b>VBS0067</b>	Automated two-step purification of 6xHis-tagged GFP with AZURA® Bio purification system .....	<b>13</b>
<b>VBS0069</b>	Purification of Sulfhydryl Oxidase .....	<b>17</b>
<b>VBS0070</b>	Ion Exchange Chromatography with AZURA® Bio purification system .....	<b>21</b>
<b>VBS0071</b>	Comparison of two column sets for antibody purification in an automated two step purification process .....	<b>25</b>
<b>VBS0072</b>	Separation of proteins with cation exchange chromatography on Sepapure SP and CM .....	<b>29</b>
<b>VBS0073</b>	Separation of proteins with anion exchange chromatography on Sepapure Q and DEAE .....	<b>33</b>
<b>VBS0074</b>	Comparison of ion exchange columns .....	<b>37</b>
<b>VBS0075</b>	Group separation with Sepapure Desalting on AZURA® Bio purification system .....	<b>41</b>
<b>VBS0077</b>	DC with GC - Determination of catecholamines in plasma with electrochemical detection .....	<b>45</b>
<b>VBS0078</b>	Automated two step purification with cation exchange chromatography and desalting .....	<b>49</b>

**Chemical analysis**

**VCH0015**  
Quantitative determination of primary aromatic amines in recycled cold-cure and flexible foams . . .53

**VCH0016**  
Determination and quantification of acrylic acid derivatives. . . . .57

**VCH0017**  
Molecular weight distribution of a broad polystyrene standard . . . . .61

**Environmental**

**VEV0078**  
Systematic HPLC method development and robustness evaluation of 13 Carbonyl DNPH derivatives Using DryLab®. . . . .69

**VEV0079**  
Determination of aromatic hydrocarbon types according to the DIN EN 12916:2016 . . . . .73

**VEV0080**  
Determination of mono- and polyaromatic hydrocarbons in diesel fuels with AZURA® Analytical HPLC system using RI detection . . . . .77

**VEV0081**  
GPC vs. SPE and subsequent determination of polycyclic aromatic hydrocarbons using GC/MS. . . .81

**VEV0082**  
GPC cleanup method for soil samples before PAHs analysis . . . . .85

**VEV0083**  
Sensitive and selective analysis of wood sugars and uronic acids for biofuel research with electrochemical detection . . . . .89

**Food, feed and beverages**

**VFD0146**  
Sensitive online SPE determination of bisphenol A in water samples . . . . .93

**VFD0150**  
Alternative xylitol extraction via hplc purification from fermented biomass . . . . .97

**VFD0152**  
Determination of aflatoxin M1 in milk . . . . . 101

**VFD0153**  
GPC cleanup of olive oil samples. . . . . 105

<b>VFD0155</b>	Semi preparative xylitol purification with dedicated sugar purification system . . . . .	<b>109</b>
<b>VFD0156</b>	Determination of osmolality of isotonic and non-isotonic beverages . . . . .	<b>113</b>
<b>VFD0157</b>	Simulated Moving Bed (SMB) - a powerful tool for continuous purification of xylitol. . . . .	<b>117</b>
<b>VFD0158</b>	Zearalenone and its major metabolites - a simple isocratic method . . . . .	<b>121</b>
<b>VFD0159</b>	Alternaria alternata - determination of main metabolites . . . . .	<b>125</b>
<b>VFD0160</b>	Determination of sugars and natural sugar substitutes in different matrices . . . . .	<b>129</b>
<b>VFD0161</b>	Determination of sugars in honey using HILIC separation and RI detection. . . . .	<b>133</b>
<b>VFD0162</b>	Separation of ascorbic acid and vitamin B complexes - essentially required nutrients . . . . .	<b>137</b>
<b>VFD0165</b>	Natural or artificial? - Determination of vanillin in vanilla products and associated marker substances . . . . .	<b>141</b>
<b>VFD0166</b>	LC-FLD analysis of 4 PAHs in olive oil samples using AZURA® GPC Cleanup system . . . . .	<b>145</b>
<b>VFD0168</b>	Oh so sweet - Quantification of steviol glycosides in stevia samples with RP-HPLC . . . . .	<b>149</b>
<b>VFD0170</b>	Scale-up of an analytical HPLC method for steviol glycosides to a preparative approach. . . . .	<b>157</b>
<b>VFD0171</b>	Advantages of preparative online SPE compared to batch LC for stevia purification. . . . .	<b>161</b>
<b>VFD0172</b>	A D E K - Easy separation of fat-soluble vitamins using GPC/SEC . . . . .	<b>165</b>
<b>VFD0173</b>	Be(e) wary - determination of neonicotinoid insecticides in honey . . . . .	<b>169</b>
<b>VFD0175</b>	Verification of the mycotoxin patulin from apple juice with isocratic HPLC . . . . .	<b>177</b>
<b>VFD0177</b>	Purification of epigallocatechin gallate and other related polyphenols from green tea by mass-triggered fractionation. . . . .	<b>181</b>

<b>VFD0178</b>	Quick and easy determination of aflatoxins in food matrices with photochemical post column derivatization . . . . .	<b>185</b>
<b>VFD0179</b>	Determination of aflatoxins in peanut samples - from extraction to high efficient detection. . . . .	<b>189</b>
<b>VFD0180</b>	Determination of aflatoxins in pistachio samples - from extraction to high efficient detection . . . . .	<b>195</b>
<b>VFD0181</b>	Determination of aflatoxins in dried fruit samples - from extraction to high efficient detection . . . . .	<b>199</b>
<b>VFD0182</b>	Determination of aflatoxins in cereal baby food samples - from extraction to high efficient detection . . . . .	<b>205</b>
<b>VFD0184</b>	Everything solved - Carbohydrate content in instant coffee with PAD . . . . .	<b>211</b>
<b>VFD0185</b>	Determination of biogenic amines with automated precolumn derivatization . . . . .	<b>217</b>
<b>VFD0186</b>	Increasing sensitivity of carbohydrate analysis by switching from refractive index to electrochemical detection . . . . .	<b>221</b>
<b>VFD0187</b>	Eurokat column coupling for carbohydrate analysis . . . . .	<b>225</b>
 <b>Pharmaceutical</b>		
<b>VPH0064</b>	Quality control of pharmaceutical solutions by determination of osmolality . . . . .	<b>233</b>
<b>VPH0065</b>	Traditional Chinese Medicine meets modern analytics - HPLC fingerprinting for the comparison of <i>Radix Paeonia alba</i> and <i>Radix Paeonia rubra</i> . . . . .	<b>237</b>
<b>VPH0066</b>	Cyclodextrin purification (Part 1): Method screening and overload studies . . . . .	<b>241</b>
<b>VPH0067</b>	Easy and fast isolation of rosmarinic acid from lemon balm with mass-directed purification . . . . .	<b>245</b>
<b>VPH0068</b>	Cyclodextrin purification (Part 2): Method transfer and purification . . . . .	<b>249</b>
<b>VPH0069</b>	Analyzing cannabis flowers according to the German Pharmacopeia - monograph 2017 . . . . .	<b>253</b>

<b>VPH0070</b>	
(C)an(n)alyze: determination of 16 cannabinoids inside flowers, oils and seeds. . . . .	<b>257</b>
<b>VPH0071</b>	
Purification of chamazulene by preparative HPLC and its scale-up . . . . .	<b>265</b>
<b>VPH0072</b>	
Analyzing cannabis flowers according to the German Pharmacopeia - monograph 2018 . . . . .	<b>271</b>
<b>VPH0073</b>	
Purify CBD and other cannabinoids by preparative HPLC . . . . .	<b>275</b>
<b>VPH0074</b>	
Purification of cannabidiol from CBD oil by preparative HPLC . . . . .	<b>283</b>
<b>Special applications</b>	
<b>VSP0013</b>	
Simplified scale up for sugars with the AZURA® RID 2.1L extended dynamic range option . . . . .	<b>291</b>
<b>VSP0014</b>	
Column choice based on Tanaka characterization - not all C18 columns are the same . . . . .	<b>295</b>
<b>VSP0016</b>	
Quantification of caffeine with the AZURA® Educational system and Mobile Control Software. . .	<b>299</b>
<b>VSP0017</b>	
Quantification of caffeine with the AZURA® Educational system and ClarityChrom software . . . . .	<b>303</b>
<b>VSP0018</b>	
Preparation of calibration and samples for the quantification of caffeine with the AZURA® Educational system. . . . .	<b>307</b>
<b>VSP0019</b>	
HPLC Basics - principles and parameters . . . . .	<b>311</b>

**Technical Notes**

**VTN0003**  
Inject, collect, repeat - Stacked injection made easy. . . . . **315**

**VTN0004**  
Investigation of carryover under consideration of different washing solvents and volumes . . . . . **319**

**VTN0005**  
When they go LOW, we go HIGH! Comparing sensitivity levels for the analysis of  
fluorescence-labeled proteins . . . . . **323**

**VTN0006**  
Boosting your sensitivity - Analysis of fluorescence-labeled proteins with semi-preparative  
FPLC and FLD . . . . . **327**

**VTN0007**  
Recycle your peaks - A comparison of two recycling methods. . . . . **331**

**VTN0008**  
Start up, shut down - Screening of pressure sensitive columns with the 8 port 2-position valve . . **337**

**VTN0009**  
HILIC - Sugars and fructooligosaccharide analysis . . . . . **341**

**VTN0010**  
Streamlining of equipment: Hybrid system for preparative and analytical LC . . . . . **345**

**VTN0011**  
Simulated Moving Bed (SMB) inline sampling . . . . . **353**

**VTN0013**  
How to optimize your purification? Your guide for two step purification - principles and system  
set up . . . . . **357**

**VTN0014**  
Two step purification with a basic set up. . . . . **365**

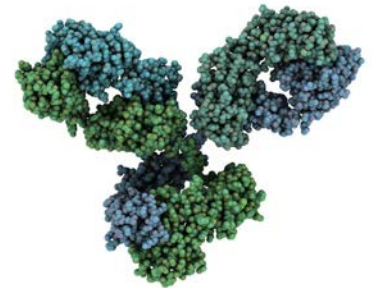
**VTN0015**  
Two step purification with the sample pump set up . . . . . **371**



# Automated two step purification of mouse antibody IgG1

Yannick Krauke, Kate Monks; applications@knauer.net

KNAUER Wissenschaftliche Geräte GmbH, Hegauer Weg 38, 14163 Berlin; www.knauer.net



## SUMMARY

This application highlights the possibility of automated purification of antibodies (IgG) with the AZURA® Bio purification system without manual interaction during purification process. The cell culture was applied with a feeding pump on a protein A affinity column to capture and purify the antibodies. These were kept in the system and in a second step applied on a gel filtration column for buffer exchange. Consequently, the obtained antibody was dissolved in the desired storage and/or working buffer.

## INTRODUCTION

Antibodies (immunoglobulins, Ig's) are part of the immune system. They can identify and bind particular antigens thereby neutralizing them. Due to their specific target recognition/binding function they have a significant importance in the biotechnology and pharmaceutical industry. Key applications are the diagnosis and treatment of diseases. Besides, antibodies are also the crucial components in numerous research applications such as Western Blots and immunoassays. Quality and purity of the IgG is crucial

for these applications. The purification of antibodies involves two to three steps, 1. capture step, (2. intermediate step), 3. polishing step. The transition from one to another step generally involves manual interaction and thus is time consuming. The aim of this application note was to establish an automated purification method on the AZURA Bio purification system combining an affinity chromatography step with a gel filtration/desalting step to exchange the buffer of the purified antibodies.

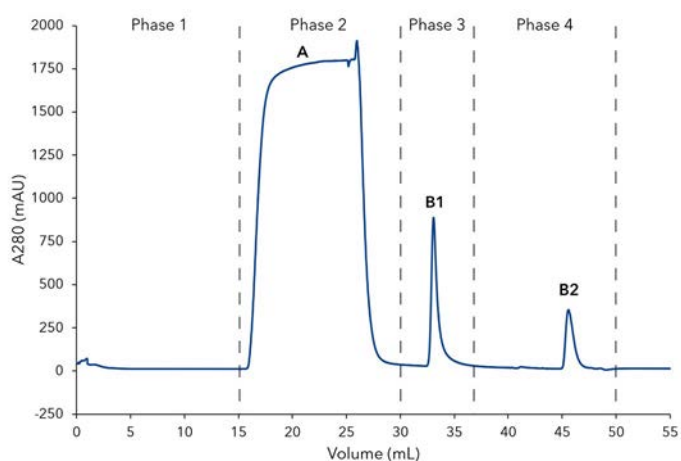


# Automated two step purification of mouse antibody IgG1

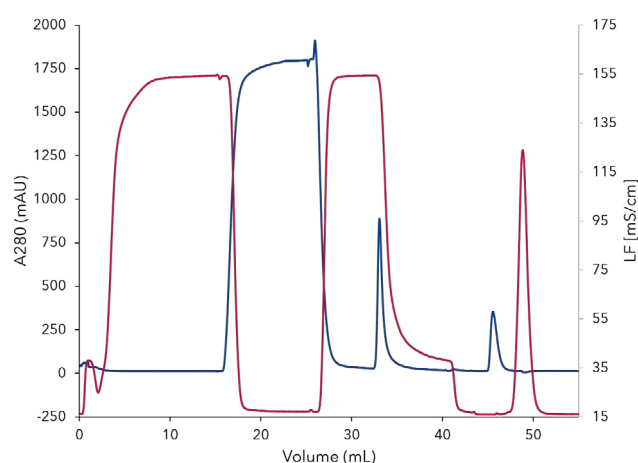
## RESULTS

The mouse immunoglobulin (IgG1) was purified from 10 mL cell culture by affinity chromatography, using a protein A column. The chromatogram of the IgG purification shows the four main phases of the procedure (Fig.1). Phase 1: equilibration of the protein A column with buffer A. Phase 2: sample injection by the feed pump. The large flow through peak (A) visualizes the cell culture matrix and proteins not bound by the protein A column. Subsequently, the column was washed with buffer A until no further peaks were detected. Phase 3: elution of the captured IgG1 with buffer B and parking in the sample loop (B1). Phase 4: immediate buffer exchange was performed by the flushing of the system with exchange buffer C and the following re-injection of the IgG1 on the desalting column. The eluting peak was recovered by the fraction collector (B2). The main aim of the second

step was the buffer exchange. The conductivity signal was recorded, demonstrating the desalting of the eluates during the purification process (Fig. 2). Finally, a SDS-PAGE was performed to control the result of the purification steps (Fig. 2). The analysis of the flow through and comparison with the injected sample show that some IgG1 did not bind to the protein A column (lane 1 and 2). The protein bands of IgG1 heavy chains (HC) and IgG1 light chains (LC) are visible at 55 kDa and 22 kDa in the SDS-PAGE. Further, a larger un-specific band at 70 kDa was detected. This band was only detected in the flow through and not in the purified IgG (lane 2, 3, 4) showing that IgG1 was not contaminated with other proteins. The IgG1 after the protein A column (lane 3) and after the desalting column (lane 4) have a similar concentration showing no protein loss in the second purification step.



**Fig. 1** Chromatogram of the two-step mouse IgG purification; Phase 1 Affinity chromatography (AC): 1 Column equilibration with buffer A; 2 Feed injection and column washing; 3 Elution of IgG from protein A column with buffer B and parking in 1mL sample loop; Phase 2 - Buffer exchange with desalting column: 4. Elution of IgG with buffer C; A-flow through; B1-elution peak of IgG from protein A column; B2-elution peak of IgG after desalting column



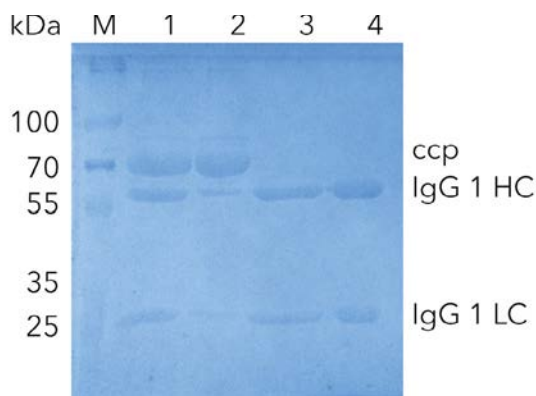
**Fig. 2** Chromatogram of the two step mouse IgG purification with UV and conductivity signal; UV signal at 280 nm in blue; conductivity signal in red; after desalting (45min) elution peak (blue) and salt peak (red) are clearly separated

## MATERIALS AND METHODS

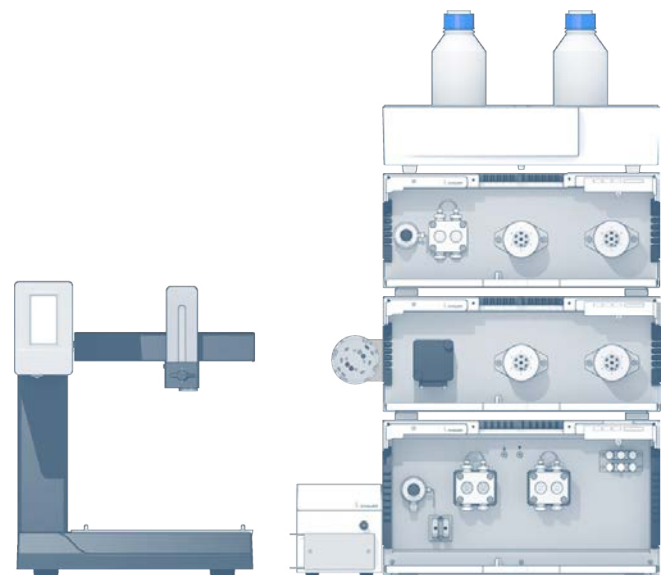
The AZURA two step purification system was used for this application. It consists of AZURA P 6.1L HPG; 1st ASM 2.1L with feed pump and two 6 port/3 channel injection valves; second ASM 2.1L with UVD 2.1S and two 6 port/3 channel injection valve; a column switching valve; a conductivity monitor and a fraction collector. The protein A column (ZetaCell protein A, 1 mL) was equilibrated with 15 mL buffer A (TBS) at 1 mL/min. Then 10 mL of feed at 1mL/min were injected and column washed with 5 mL buffer A at 1 mL/min. The antibody was then eluted with 10 mL elution buffer B (0.2 M Na Citrate, pH 3) and the eluting antibody collected in sample loop. Finally, the protein was re-injected and eluted with 15 mL of buffer C (PBS pH 7.4) over the desalting/gel filtration column at 1 mL/min. The UV signal (280 nm) and the conductivity signal were recorded.

## CONCLUSION

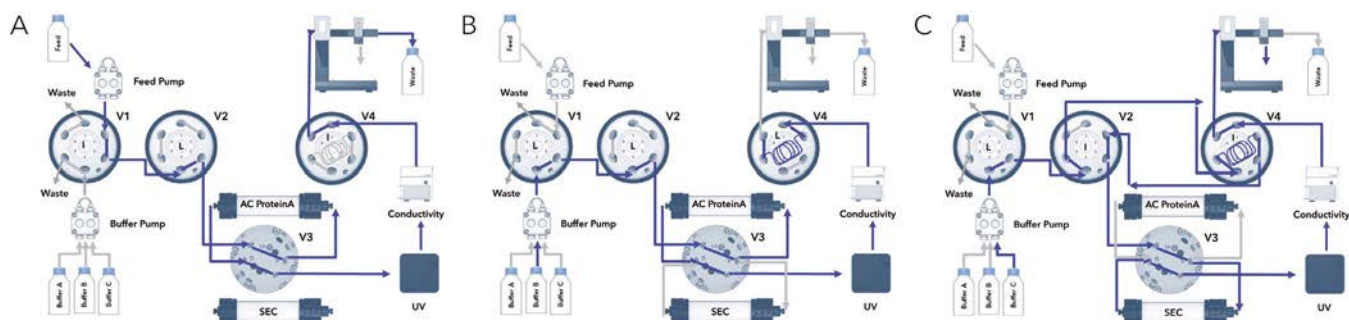
Mouse IgG was successfully purified from cell culture medium by an automated combination of an affinity chromatography and gel filtration method on the two-step dedicated AZURA Bio purification system. No manual interaction was necessary. The method setup could easily be adapted to other purification protocols for the separation of biomolecules. This application is an example of a time-saving automation of protein purification and can be easily adapted to various protein purification protocols.



**Fig. 3** SDS-PAGE of IgG1 at different purification steps; M) Marker in kDa; 1) cell culture supernatant; 2) flow through; 3) pure IgG1 after elution from protein A column; 4) pure IgG1 after desalting column; ccp cell culture proteins; IgG1 HC (heavy chain); IgG1 LC (light chain)



## ADDITIONAL MATERIALS AND METHODS



**Fig. A1** Flow chart of the two - step purification illustrating major method steps; A Feed injection and antibody binding on protein A column, flow through to waste, washing afterwards with buffer A (not shown); B Protein elution from protein A column with buffer B and protein parking in sample loop; C Re-injection of parked protein on SEC desalting column, buffer and pH exchange using buffer C, fractionation of target peak; valve positions = I) injection, L) load.

The system configuration and the different valve settings are shown in Fig. A1. The first injection valve (V1) is used for the injection of the sample. To this valve the feed pump and the buffer pump are connected. The other two injection valves are necessary for the inversion of the flow direction (V2 + V4). They also switch the flow to the waste/fraction collector and in/out of the sample loop. The sample loop allows the collection and (re)injection of the peak of interest. The two columns are connected to the column switching valve (V3). In the initial configuration (Fig. A1 A) the sample is injected onto the column by the feed pump. The non-binding protein is directed to the waste. After washing the column, IgG is eluted with eluent B (Fig. A1 B). The valves are switched to the peak parking position (V2 + V4 in Load position). The eluting protein is collected in the sample loop. Subsequently, the collected protein is automatically re-injected onto the second column by changing the valve position for V2 and V4 from Load to Inject and for V3 from position 1 (column 1) to position 2 (column 2) (Fig. A1 C). The flow is inverted and the sample loop is emptied. The eluted protein peak is fractionated by a fraction collector. No manual interaction is necessary during the purification.

**Tab. A1** Method parameters

Eluent A	Washing buffer: TBS (Tris-buffered saline)		
Eluent B	Elution buffer: 0.2 M NaCitate, pH 3		
Eluent C	Storage buffer: PBS (phosphate buffered saline) pH 7.4		
Flow rate	1 mL/min	System pressure	1.5 bar
Column temperature	RT	Run time	55 mL
Injection volume	10 mL	Injection mode	Feed pump
Detection wavelength	280 nm	Data rate	500 ms

**Tab. A2** Purification steps run at a flowrate of 1 mL/min; AC - affinity chromatography, GF - gel filtration

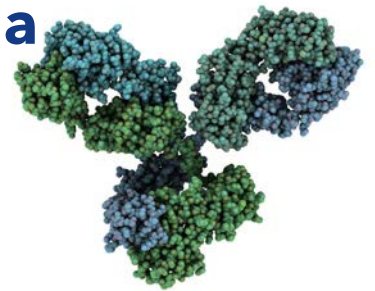
Time (mL)	% A	% B	% C	Feed pump	Method	Description
0-15	100			-		Equilibration
15-25				100	AC	Injection
25-30	100				AC	Washing
30-40		100			AC	Elution and peak parking
40-55			100		GF	Re-injection buffer

**Tab. A3** System configuration

Instrument	Description	Article No.
Pump	AZURA P 6.1 L, HPG, ceramic, 50 mL	<a href="#">APH68FB</a>
Flow cell	3 mm, 2 µL	<a href="#">A4045</a>
Assistant 1	AZURA ASM 2.1L Left: P 4.1S, 50 bar, 50 ml, ceramic Middle: 6Port2Pos, 1/16", PEEK, 200 bar Right: 6Port2Pos, 1/16", PEEK, 200 bar	<a href="#">AYBLECEC</a>
Assistant 2	AZURA ASM 2.1L Left: UVD 2.1S Middle: 6Port2Pos, 1/16", PEEK, 200 bar Right: 6Port2Pos, 1/16", PEEK, 200 bar	<a href="#">AYCAECEC</a>
Valve	Column selection valve	<a href="#">AWB00FC</a>
Fraction collector	Foxy R1	<a href="#">A59100</a>
Conductivity monitor	CM2.1S	<a href="#">ADG30</a>
Column 1	Protein A 1ml column for crude samples	upon request
Column 2	Sepapure Desalting 5 mL	<a href="#">020X460SPZ</a>
Software	PurityChrom, standard licence	<a href="#">A2650</a>



# Comparison of IgG purification with two different protein A media



Michaela Schulze, Kate Monks; [applications@knauer.net](mailto:applications@knauer.net)  
KNAUER Wissenschaftliche Geräte GmbH, Hegauer Weg 38, 14163 Berlin; [www.knauer.net](http://www.knauer.net)

## SUMMARY

The purification of antibodies is generally performed with protein A column materials. Two prepacked protein A columns from two different suppliers were compared in their ability to purify immunoglobulin antibodies (IgG) from human plasma. Capacity and yield were compared and revealed no significant differences in the performances of the two investigated columns.

## INTRODUCTION

Today, the most widely used affinity chromatography purification procedure in industry is the capture of antibodies using protein A ligand. Affinity chromatography is used to isolate and enrich proteins or nucleic acids from complicated mixtures like human plasma. The principle is based on biospecific interactions between two reaction partners. The column matrix contains a covalently bound ligand to which the substance of interest specifically binds. A certain

buffer is needed to elute the antibodies bound to the matrix. This type of chromatography is very efficient and delivers a highly clean protein. An AZURA® Bio purification system was used for comparison of two affinity materials. Here, an automated method to purify IgG from human plasma was used. Two protein A media were compared. The capacity of the columns to bind IgG was determined for both materials.

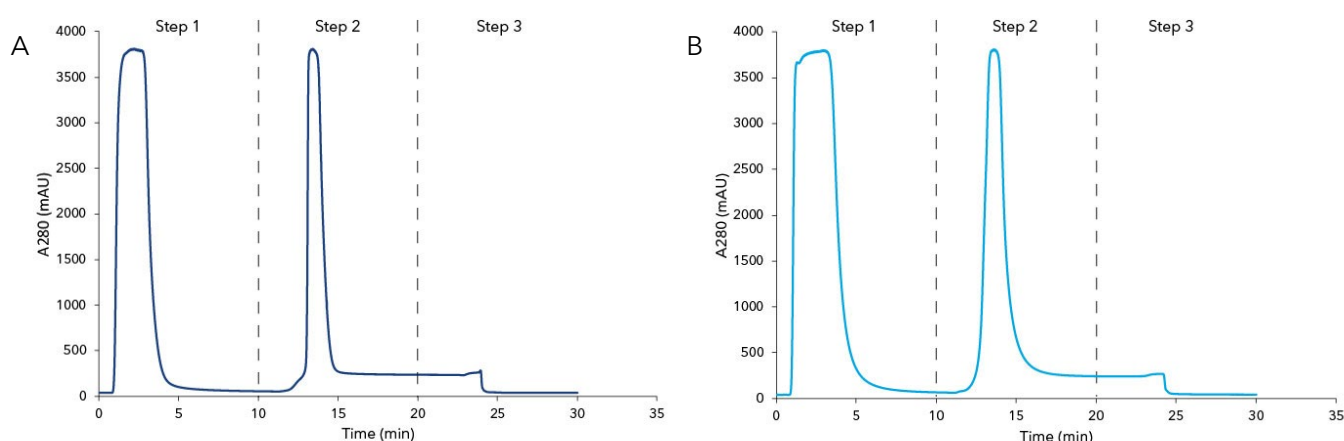


# Comparison of IgG purification with two different protein A media

## RESULTS

The IgG were purified from 500  $\mu$ L human plasma by affinity chromatography using protein A columns. The eluted antibodies were then automatically collected with a fraction collector. The chromatogram of the whole purification process is divided in three steps (**Fig 1 A&B**). During the first step, the protein A column was equilibrated with buffer A followed by feed injection. The proteins that did not bind to the protein A columns went to waste and were visible as large flow through peak in step one. Thereafter, the column was washed with buffer A until no further peaks were detected. During step two, the antibodies

were eluted from the column with buffer B and collected in 1 mL fractions. In the last step, the protein A columns were equilibrated with the buffer A in preparation for the next sample injection. Three runs were performed for each column material. The amount of purified protein was with 6 mg IgG originating from 500  $\mu$ L human plasma are similar (**Tab 1**). Moreover, a SDS PAGE analysis was performed with the IgG samples to check the purity of the individual fractions. The protein bands of IgG heavy chains (HC) and IgG light chains (LC) are visible at 48 kDa and 25 kDa in the SDS-PAGE (**Fig A1**, suppl. material).



**Fig. 1** Chromatogram of antibody purification with Protein A HP column from vendor x (A) and Sepapure Protein A FF (B) columns; Step 1: injection peak of human plasma and column washing; Step 2: elution peak of IgG from protein A column with buffer B; Step 3: column equilibration with buffer A

**Tab. 1** Total and fraction concentrations of IgG purified with Sepapure Protein A FF or Protein A HP column from vendor x for three runs

Run	Column	IgG concentration in fraction (mg/mL)	Fraction size (mL)	Total IgG amount in fractions (mg)
1	Sepapure Protein A FF	0.82	7	5.74
2	Sepapure Protein A FF	0.83	7	5.81
3	Sepapure Protein A FF	0.87	7	6.09
4	Protein A HP vendor x	0.95	6	5.70
5	Protein A HP vendor x	1.00	6	6.00
6	Protein A HP vendor x	1.04	6	6.24

## MATERIALS AND METHODS

In this application an AZURA Bio purification system was used. It consisted of an AZURA P 6.1L LPG metal-free pump, AZURA ASM 2.1L assistant module with feed pump and two 6 port/3 channel injection valves, an AZURA DAD 2.1L diode array detector with 10 mm, 10  $\mu$ L flow cell cartridge; AZURA CM 2.1 conductivity monitor and a fraction collector.

The two 5 mL protein A columns were equilibrated with 20 mL buffer A (20 mM phosphate Buffer pH 7.0) at 2 mL/min. Then 500  $\mu$ L human plasma were injected and the column washed with 20 mL buffer A at 2 mL/min.

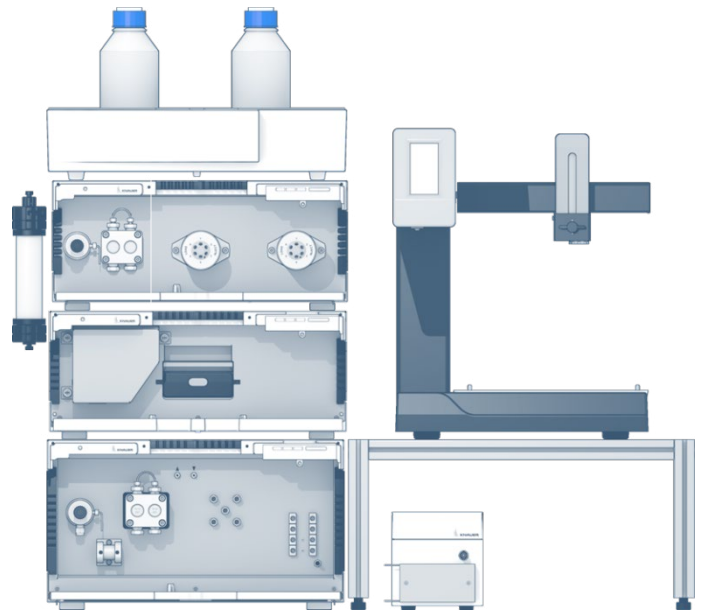
The antibodies were then eluted with 20 mL elution buffer B (0.1 M Glycin-HCL, pH 2.7) and collected with the fraction collector. The concentrations of the IgG fractions from each individual run were determined with a NANODROP 2000 [Tab 1](#)). The UV signal was measured at 280 nm and conductivity signal was recorded.

## CONCLUSION

Human immunoglobulin antibodies (IgG) were successfully purified with both protein A materials via affinity chromatography with the AZURA Bio purification system. An average of 6 mg IgG was purified from 500  $\mu$ L of human plasma with both columns. When compared via SDS PAGE, in both cases eluted proteins are identical in purity. All in all, it can be concluded that the purification is quantitatively and qualitatively identical for both tested column materials.

## REFERENCES

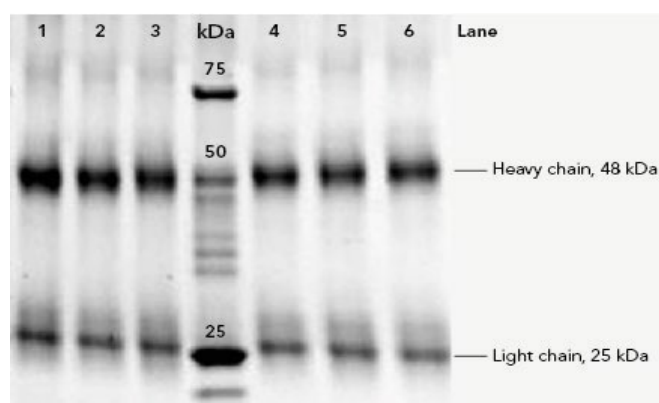
[1] Janeway CA Jr, Travers P, Walport M, et al.; Immunology: The Immune System in Health and Disease. 5th Edition, New York; Garland Science, 2001



## ADDITIONAL MATERIALS AND METHODS

**Tab. A1** Method parameters

Buffer A	20 mM phosphate buffer pH 7.0		
Buffer B	100 mM Glycin - HCl pH 2.7		
Gradient	Time [min]	% A	% B
	0-10	100	0
	10-20	0	100
Flow rate	20-30	100	0
	2 mL/min	System pressure	0 bar
Column temperature	25°C	Run time	30 min
Injection volume	0.5 mL	Injection mode	Full loop
Detection wavelength	280 nm	Data rate	10 Hz



**Fig. A1** SDS Page of the eluted IgG from human plasma; Lanes 1 - 3 IgG (4 µg) purified from three runs with the Sepapure Protein A FF column; Marker (10 µL) in kDa; Lanes 4-6 IgG (4 µg) purified from three runs with the vendor x column

**Tab. A2** System configuration

Instrument	Description	Article No.
Pump	AZURA P 6.1L LPG, metal-free	<a href="#">APH64EB</a>
Detector	AZURA DAD 2.1L	<a href="#">ADC01</a>
Flow cell	10mm, 10µL, Ti, 300bar	<a href="#">AMC38</a>
Assistant	<b>AZURA ASM 2.1L</b> Left: Pump with pressure sensor, 50 mL pump head, SSt Middle: 6 port 2 position injection valve, 1/16" connectors Right: 6 port 2 position injection valve, 1/16" connectors	<a href="#">AYBHECEC</a>
Fraction collector	Foxy R1	<a href="#">A59100</a>
Conductivity monitor	CM 2.1S	<a href="#">ADG30</a>
Column 1	Protein A HP 5 mL from vendor x	-
Column 2	Sepapure Protein A FF, 5 mL Column	<a href="#">020X39FSPZ</a>
Software	PurityChrom 3D Option	<a href="#">A2654</a>

## RELATED KNAUER APPLICATIONS

[VBS0063](#) - Automated two - step purification of mouse antibody IgG1 with AZURA Bio purification system

[VBS0067](#) - Automated two-step purification of 6xHis-tagged GFP with AZURA Bio purification system

[VBS0068](#) - Fast and robust purification of antibodies from human serum with a new monolithic protein A column

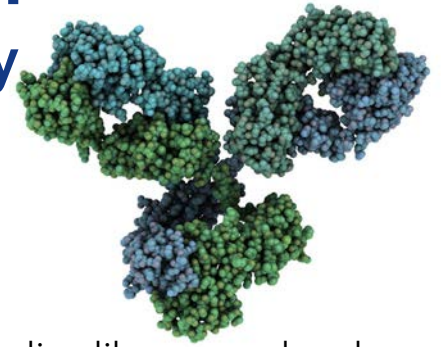
[VBS0066](#) - Fast and sensitive size exclusion chromatography of IgG antibody

[VBS0069](#) - Purification of Sulfhydryl Oxidase



# Fast and sensitive size exclusion chromatography of IgG antibody

Lilit Avagyan, Michaela Schulze, Hagen Schlicke, Kate Monks; applications@knauer.net  
KNAUER Wissenschaftliche Geräte GmbH, Hegauer Weg 38, 14163 Berlin; www.knauer.net



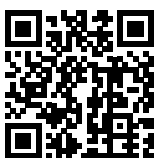
## SUMMARY

Size exclusion chromatography (SEC) for analysis of antibodies like monoclonal immunoglobulin G (IgG) is a commonly used separation technique. AZURA® UHPLC system and TOSOH TSKgel UP-SW3000 silica based columns allow a faster and more sensitive determination of IgG compared to e.g. USP 129 application.

## INTRODUCTION

The application field of monoclonal antibodies (mAb) goes from diagnostic kits up to active pharmaceutical ingredients for the treatment of autoimmune diseases and cancer. Since the commercialization of the first therapeutic antibody product in 1986, this class of biopharmaceutical products has grown significantly. Until 2020 about 70 new mAb products are predicted to be developed [1]. In the field of bio-chromatography, the research on separation of mAb increase

accordantly. The SEC is the first-choice application for this purpose. However, the duration of the method is usually very long and the consumption of chemicals is high. Here, the increase of sensitivity and reduction of analysis time was reached by using silica based TOSOH TSKgel UP-SW3000 columns with 2  $\mu\text{m}$  particle size and different column length. The analysis was performed on AZURA UHPLC system with AZURA DAD 6.1L diode array detector.

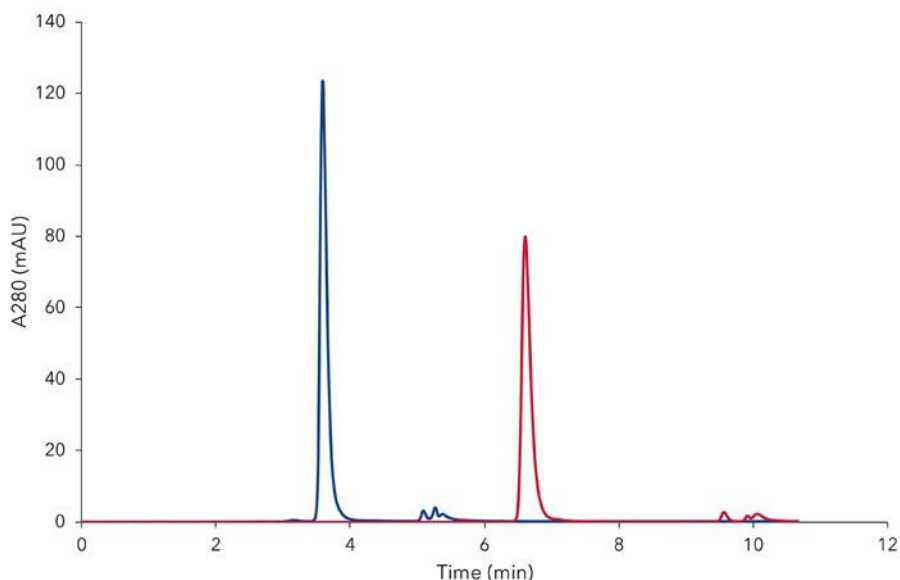


# Fast and sensitive size exclusion chromatography of IgG antibody

## RESULTS

**Fig. 1** shows an overlay of two chromatograms, obtained by applying of IgG standard (diluted up to 1 mg/mL) on TSKgel UP-SW3000 columns with 300 mm (red) and 150 mm (blue) length. The retention time of the main peak representing IgG was recorded 6.61 and 3.59 min respectively (**Tab. 1**). The highest response value of 24.8 mAU/ $\mu$ g was reached with

150 mm length column. This is an increase by the factor of 1.55 and 7.51 compared to the 300 mm length column and to the certificated data respectively. The run time could be reduced from 30 (USP application) to 7 min (150 mm column). Compared to certificate data sheet and USP method (**Tab. 1**), the consumption of the sample was reduced up to four times.



**Fig. 1** Chromatograms overlay of IgG, obtained from measurement of diluted sample 1 mg/mL measured with 300 mm (red) and 150 mm (blue) columns, injection volume 5  $\mu$ L

**Tab. 1** Result table of IgG standard, measured via AZURA UHPLC system and TOSOH columns, compared to certificate data of standard.

Parameters			Certificate data
Column material	Silica based	Silica based	Packing L59
Particle size ( $\mu$ m)	2	2	5
Column size (mm)	4.6 x 300	4.6 x 150	7.8 x 300
Flow rate (mL/min)	0.4	0.4	0.5
Sample concentration (mg/mL)	1	1	10
Injection volume ( $\mu$ L)	5	5	20
Peak height (mAU)	80	124	650
Response (mAU/ $\mu$ g)	16.0	24.8	3.3
Retention time (min)	6.61	3.59	15.48
Run time (min)	12	7	30

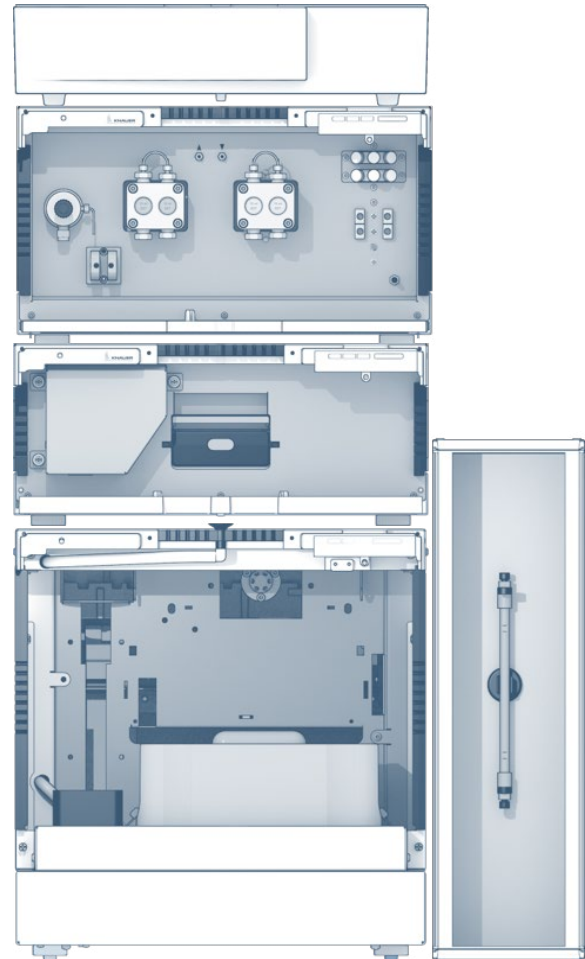
## MATERIALS AND METHOD

The AZURA UHPLC system consists of AZURA P 6.1L HPG pump, AZURA DAD 6.1L detector, LightGuide flow cell (10 mm, 2 µL), AZURA AS 6.1L autosampler, AZURA CT 2.1 thermostat and ClarityChrom software. As mobile phase a phosphate buffer with 0.14 M monobasic potassium phosphate, 0.06 M dibasic potassium phosphate and 0.25 M potassium chloride (pH 6.2) was used. The standard "monoclonal IgG system suitability" (USP catalog No. 1445550) was obtained by Sigma Aldrich. The stock solution (10 mg/mL) was diluted with mobile phase and used for analyses. The separation was applied on two TSK-gel UP-SW3000 columns with 2 µm particle size and 4.6 x 300 mm and 4.6 x 150 mm column dimensions. The measurements were performed in isocratic mode with 0.4 mL/min flow rate. The injection volume was 5 µL. Determination took place at 280 nm, sampling rate of 20 Hz and time constant 0.05 sec. The column thermostat was adjusted to 25 °C. For characterization of sensitivity the response (R) of the signals was calculated according to the following equation, where H is the height of the peak (in mAU) and m is the mass of the sample (in µg):

$$R [mAU/\mu g] = \frac{H [mAU]}{m [\mu g]}$$

## CONCLUSION

As the results show the application for determination of IgG could be significantly improved concerning run time and sensitivity by the using of AZURA UHPLC system and TOSOH TSKgel UP-SW3000 silica based columns.

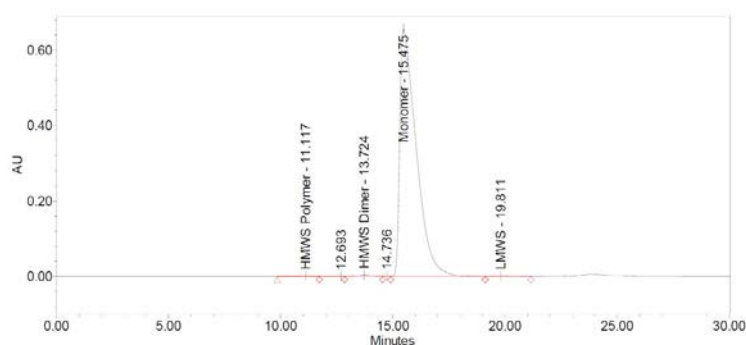


## REFERENCES

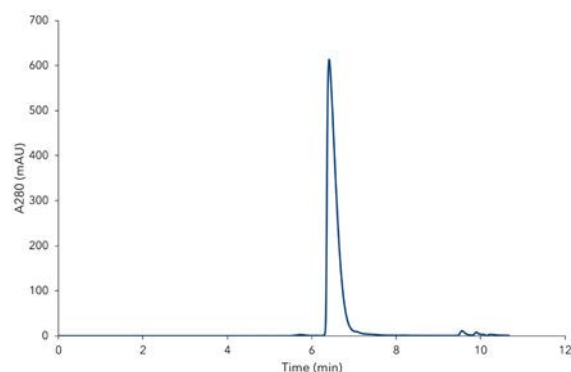
- [2] Dawn M Ecker, Susan Dana Jones and Howard L Levine, Jones SD, Levine HL, The therapeutic monoclonal antibody market, MAbs. 2015 Jan-Feb; 7(1): 9-14.

## ADDITIONAL RESULTS

**Fig. A2** depicts a chromatogram of stock solution of IgG standard. 5 µL of the standard was injected on 300 mm TSKgel UP-SW3000 column. The obtained peak maximum value is 615.3 mAU (**Fig. A2**). Compared to certificate data sheet (**Fig. A1**) and USP method (**Tab. 1**), the consumption of the sample was reduced up to 4 times.



**Fig.A1** Chromatogram of IgG, obtained from USP-standard certificate. Sample concentration 10 mg/mL, injection volume 20 µL



**Fig.A2** Chromatogram of IgG, obtained from measurement of stock solution. Sample concentration 10 mg/mL, injection volume 5 µL

## ADDITIONAL MATERIALS AND METHODS

**Tab.A1** Method parameters

Eluent A	Phosphate buffer, pH 6.2		
Gradient	isocratic, 100 % A		
Flow rate	0.4 mL/min	System pressure	320 bar, 124 bar
Column temperature	25°C	Run time	12 min
Injection volume	5 µL	Injection mode	Partial loop fill
Detection wavelength	280 nm	Data rate	20 Hz
		Time constant	0.05 sec

**Tab.A2** System configuration

Instrument	Description	Article No.
Pump	AZURA P 6.1L HPG, 5 mL, SS	<a href="#">APH35GA</a>
Autosampler	AZURA AS 6.1 L	<a href="#">AA01AA</a>
Detector	AZURA DAD 6.1L	<a href="#">ADC11</a>
Flow cell	LightGuide 10 mm, 2 µL	<a href="#">AMC19XA</a>
Thermostat	AZURA CT 2.1	<a href="#">A05852</a>
Columns	TSKgel UP-SW3000, 4.6 mm ID x 30 cm, 2 µm TSKgel UP-SW3000, 4.6 mm ID x 15 cm, 2 µm	
Software	ClarityChrom	<a href="#">A1672-9</a>

## RELATED KNAUER APPLICATIONS

[VBS0063](#) - Automated two - step purification of mouse antibody IgG1 with AZURA Bio LC Lab system

[VBS0064](#) - Comparison of IgG purification by two different protein A media

[VBS0067](#) - Automated two-step purification of 6xHis-tagged GFP with AZURA Bio LC

[VBS0068](#) - Fast and robust purification of antibodies from human serum with a new monolithic protein A column

[VBS0069](#) - Purification of Sulphydryl Oxidase

## Automated two step purification of 6xHis-tagged GFP

Ulrike Maschke, Yannick Krauke, Kate Monks; [applications@knauer.net](mailto:applications@knauer.net)  
KNAUER Wissenschaftliche Geräte GmbH, Hegauer Weg 38, 14163 Berlin;  
[www.knauer.net](http://www.knauer.net)

### SUMMARY

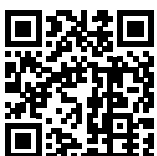
Affinity chromatography by His-tag is one of the most widespread purification techniques for recombinant proteins. In most cases it requires an additional cleaning/polishing step. This application highlights the possibility of combining two subsequent chromatography protocols without manual interaction using the AZURA® Bio purification system.



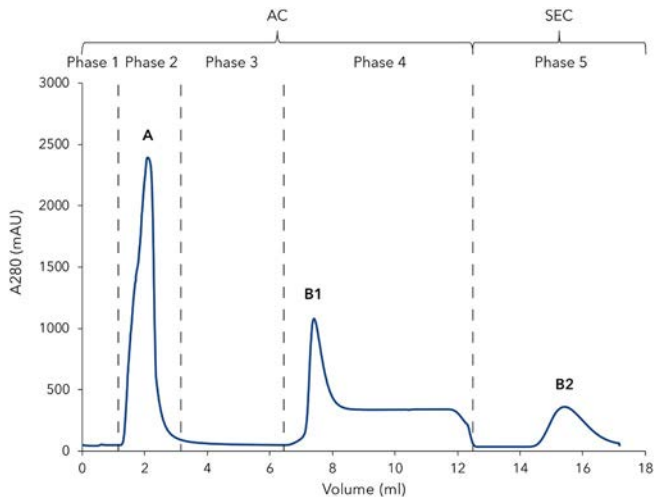
### INTRODUCTION

Affinity chromatography (AC) is one of the most efficient techniques to purify recombinant proteins. Mostly, AC is performed on crude samples like bacterial lysates containing the recombinant protein that is genetically engineered to be expressed with a tag that enables the specific capture of the recombinant protein. These highly efficient tags are used for affinity binding to specific affinity chromatography materials. A variety of tags is available among which the polyhistidine tag is the most widespread one. In this application, six histidine (6xHis) residues were attached to the green fluorescent protein (GFP). The histidine

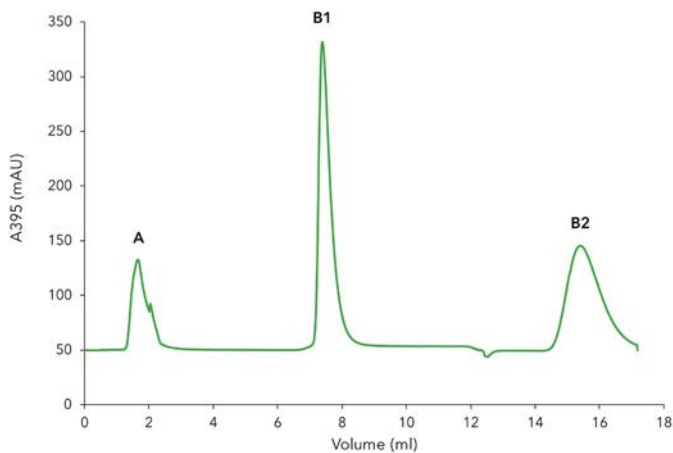
residues bind with very high affinity to the immobilized metal ions on the column (immobilized metal ion affinity chromatography (IMAC)). In many protocols, an additional step is recommended to reach higher purity or to change the buffer of the purified protein to a suitable storage buffer. Here, size exclusion chromatography was used as second step to exchange the buffer of the purified protein. Purification of recombinant proteins can be performed manually or by using a chromatography system combining two steps automatically to save time and effort.



# Automated two-step purification of 6xHis-tagged GFP



**Fig. 1** Chromatogram of the two-step 6xHis-GFP purification; 280 nm UV signal, Step1) Affinity chromatography (AC)/ Ni- NTA column: 1) Column equilibration; 2) Sample injection; 3) Column washing; 4) Elution of 6xHis-GFP and parking in 1 mL sample loop; Step2) Buffer exchange with desalting co-lumn: 5) Elution of 6xHis-GFP ; A) flow through of unbound protein; B1) elution peak of 6xHis-GFP from Ni-NTA column; B2) elution peak of 6xHis-GFP



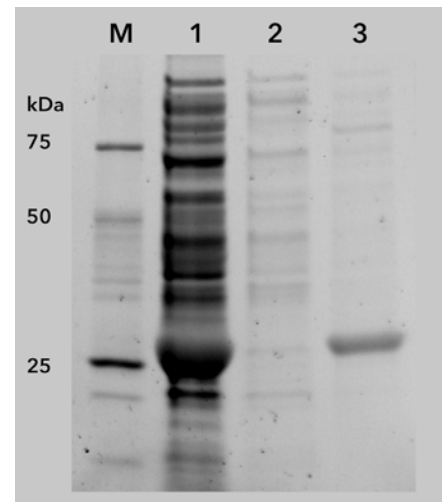
**Fig. 2** Chromatogram of the two-step 6xHis-GFP, GFP detection with 395 nm UV signal, A) flow through of unbound pro-tein; B1) elution peak of 6 x His-GFP from Ni - NTA column; B2) elution peak of 6 x His-GFP

## RESULTS

The chromatogram of the 6xHis-GFP purification shows the five phases of the two-step protocol (**Fig. 1**). After equilibration (**Fig. 1**, phase 1) the lysate was injected and the GFP bound to the Ni-NTA affinity column via the 6xHis-tag. All other non-binding proteins and impurities are in the large flow through peak (**Fig. 1**, phase 2, peak A). Subsequently, the column was washed until the baseline was stable (**Fig. 1**, phase 3). The eluted protein (**Fig. 1**, phase 4, peak B1) was collected in a sample loop and re-injected on the desalting column (**Fig. 1**, phase 5) to exchange the buffer from high imidazole concentrations to a buffer without imidazole. The purified protein (**Fig. 1**, peak B2) was collected by the fraction collector.

Additionally to the unspecific photometrical detection of all proteins at 280 nm, GFP-signal was recorded at 395 nm (**Fig. 2**) with the multi-wavelength detector. Most of the 6xHis-tagged GFP bound to the column as only a small peak for GFP is visible in the flow through. The purification results were confirmed by SDS-Page (**Fig. 3**). The cell lysate (**Fig. 3**, lane 1) shows a prominent band representing the overexpressed 6xHis GFP. This band is cleared in the flow through (**Fig. 3**, lane 2), confirming that most of the tagged protein bound to the column. The eluted sample (**Fig. 3**, lane 3) shows the purified 27 kDa 6xHis-GFP with only minor contaminations.

**Fig. 3** SDS-PAGE of two-step 6xHis-GFP purification M - marker, 1) lysate before purification, 2) flow th-rough, 3) eluted 6xHis-GFP (27 kDa) after two-step purification

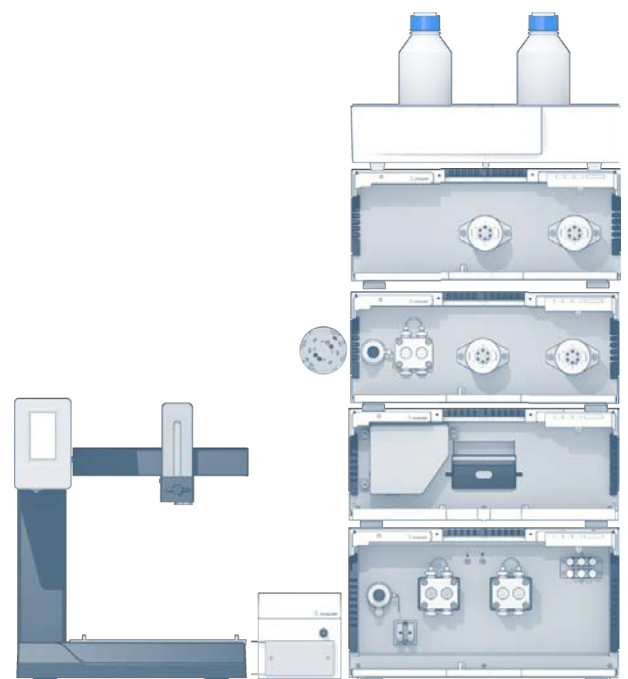


## MATERIALS AND METHODS

The AZURA two-step purification system with a multi-wavelength detector was used for this application. It consists of AZURA P 6.1L HPG, one autosampler AZURA ASM 2.1L with feed pump and two 6 port/3 channel injection valves; a second ASM 2.1L with two 6 port/3 channel injection valves; the MWD 2.1L multi-wavelength detector, a column switching valve, a conductivity monitor, and a fraction collector. The Sepapure FF Ni-NTA 1 mL column was equilibrated prior to the run with 15 mL load/wash buffer (PBS pH 7.5, 10 mM imidazole) at 1 mL/min. 100  $\mu$ L lysate containing the 6 x His tagged GFP was loaded on to the column at a flowrate of 0.3 mL/min. The column was washed with 4 mL load/wash buffer at a flowrate of 1 mL/min. The load/wash buffer had a low amount of imidazole to reduce non-specific binding of impurities. 6 x His tagged GFP was eluted with 5 mL elution buffer (PBS, pH 7.5, 500 mM imidazole) and collected in a 1 mL sample loop. The eluted protein was re-injected on to a 5 mL desalting column to exchange the buffer from high imidazole concentrations from the elution buffer to the final desalting buffer without imidazole. 7 mL desalting buffer (PBS pH 7.4) was used for the gel filtration run at a flowrate of 1 mL/min. The protein was collected in a fraction collector. The UV signal at 280 nm and 395 nm, as well as the conductivity signal were recorded.

## CONCLUSION

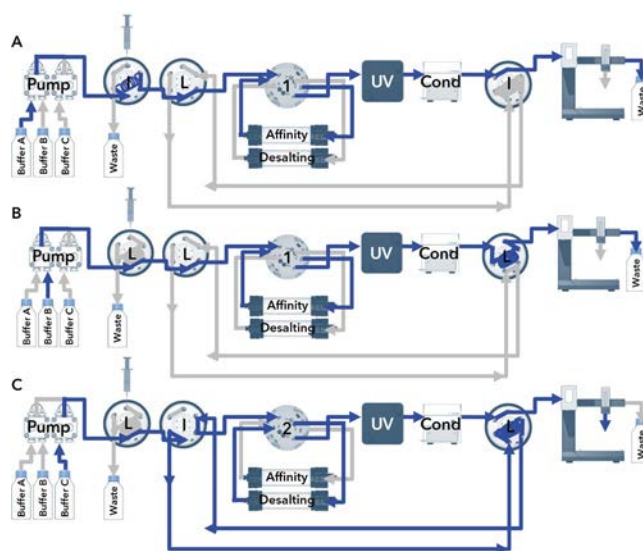
6xHis-tagged GFP was purified by an automated two-step protocol combining an affinity chromatography method to capture 6xHis-tagged GFP with a subsequent buffer exchange step by size exclusion chromatography. This automatization requires no time consuming manual interaction. The method set up is an excellent example for a two-step protein purification and can be adapted to a variety of protein purification protocols. The benefit of a multi wavelength detector was shown measuring at two different wavelengths.



## ADDITIONAL MATERIALS AND METHODS

**Tab.A1** Method parameters

Eluent A	Loading/washing buffer: PBS (phosphate-buffered saline) pH 7.5, 10 mM imidazole		
Eluent B	Elution buffer: PBS pH 7.5, 500 mM imidazole		
Eluent C	Desalting buffer: PBS pH 7.4		
Gradient	Volume [mL]	% A	% B
	0-0.5	100	0
	0.5-2	100	0
	2-6	70	30
	6-11	0	100
	11-18	0	100
Flow rate	1 mL/min	System pressure 1.0 bar	
Column temperature	RT	Run time	18 min
Injection volume	100 µL	Injection mode	Full loop
Detection wavelength	280 nm 395 nm	Data rate	-
		Time constant	500 ms



**Fig. A1** Flowchart; A) sample injection, B) elution and peak parking, C) reinjection

**Tab.A2** System configuration

Instrument	Description	Article No.
Pump	AZURA P 6.1L HPG, ceramic, 50 mL	<a href="#">APH68FB</a>
Detector	MWD 2.1L	<a href="#">ADB01</a>
Flow cell	10 mm, 1/16", 10 µL, 300 bar, biocompatible	<a href="#">AMC38</a>
Assistant 1	AZURA ASM 2.1L Left: feed pump 50 ml Ti Middle: Injection valve 6/3 channel PEEK Right: injection valve 6/3 channel PEEK	<a href="#">AYBHECEC</a>
Assistant 2	Left position: - Injection valve 6/3 channel PEEK Right position: injection valve 6/3 channel PEEK	
Conductivity monitor	AZURA CM 2.1S	<a href="#">ADG30</a>
Flow cell	Preparative, flow rates up to 100 mL	<a href="#">A4157</a>
Valve	Column selection valve	<a href="#">AWB00FC</a>
Column	Sepapure FF Ni-NTA 1 mL Sepapure Desalting 5 mL	<a href="#">010X39FPSZ</a> <a href="#">020X460SPZ</a>
Fraction collector	Foxy R1	<a href="#">A59100</a>
Software	PurityChrom® 5 Upgrade	

## RELATED KNAUER APPLICATIONS

[VBS0063](#) - Automated two - step purification of mouse antibody IgG1 with AZURA Bio purification system

[VBS0064](#) - Comparison of IgG purification by two different protein A media

[VBS0068](#) - Fast and robust purification of antibodies from human serum with a new monolithic protein A column

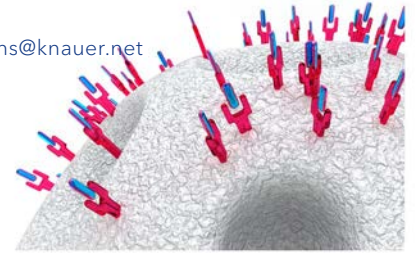
[VBS0066](#) - Fast and sensitive size exclusion chromatography of IgG antibody

[VBS0069](#) - Purification of Sulphydryl Oxidase



# Purification of Sulphydryl Oxidase

Ulrike Krop, David Thiesing<sup>1</sup>, Tigran Kharatyan<sup>1</sup>, Jessica Thiesing-Paul, Kate Monks; applications@knauer.net  
KNAUER Wissenschaftliche Geräte GmbH, Hegauer Weg 38, 14163 Berlin; www.knauer.net  
<sup>1</sup> SternEnzym GmbH & Co. KG, Ahrensburg, Germany



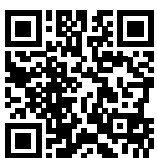
## SUMMARY

Enzymes play a key role in food production. The use of recombinant enzymes for the food industry is a growing market. In this application we describe the purification of sulfhydryl oxidase (SOx) by affinity chromatography. Its stabilizing potential makes this enzyme an ideal candidate for food applications where proteins play a role, for example baking products or egg dishes. Additionally SOx is commercially rare and the broad application field provides huge potential for the food industry.

## INTRODUCTION

With the recombinant expression of functional proteins through the development of modern biotechnology, enzymes have a special status in industry and research. Sulfhydryl oxidase (SOx) catalysis the formation of disulfide bonds within and between proteins which naturally plays a fundamental role for the

folding of proteins during cell metabolism. In industrial food production, intermolecular crosslinks of proteins can have a stabilizing effect on products and could be used as a biological substitute for chemical stabilizers. [1] The future production and the commercial distribution is therefore of high interest.

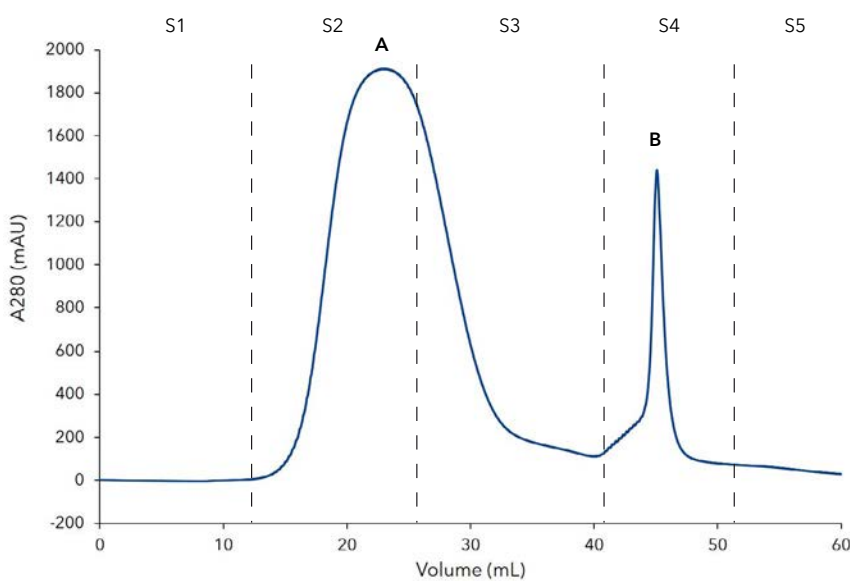


# Purification of Sulphydryl Oxidase

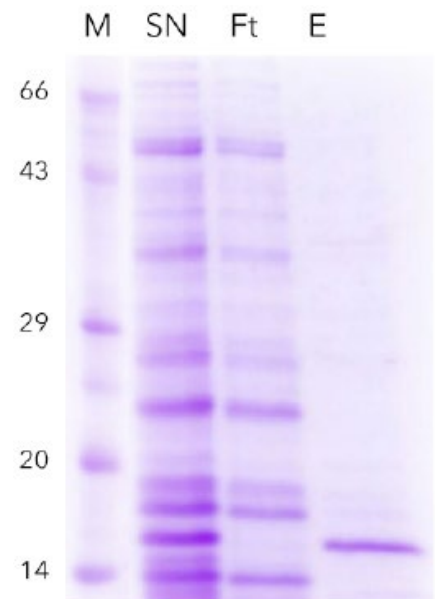
## RESULTS

The recombinantly produced His-tagged SOx was purified with an immobilized metal ion chromatography (IMAC) resin. The chromatogram is shown in **Fig. 1**. Peak A represents the flow-through of unbound proteins. The His-tagged SOx was eluted with buffer B (Peak B) and collected via the fraction valve. The collected sample was analyzed by SDS-PAGE to check for impurities and evaluate the purity of the collected

sample (**Fig. 2**). The recombinant His-tagged SOx has a molecular weight of 15 kDa. The supernatant shows a prominent 15 kDa band representing the expressed SOx. This band is not visible in the flow through fraction. Most of the His-tagged SOx bound to the IMAC column. Only minor contaminations are visible in the eluted protein fraction. A standard of SOx at a concentration of 1.13 g/L was prepared.



**Fig. 1** Chromatogram of SOx affinity purification; A) flow through of unbound protein, B) elution peak of SOx; S1) column equilibration, S2) sample application, S3) column washing, S4 - elution of His-tagged Sox, S5 - re-equilibration



**Fig. 2** SDS-PAGE of SOx purification, M) marker, SN) supernatant with overexpressed protein Ft) flow through, E) eluted protein (purified SOx protein ~ 15 kDa)

## MATERIALS AND METHODS

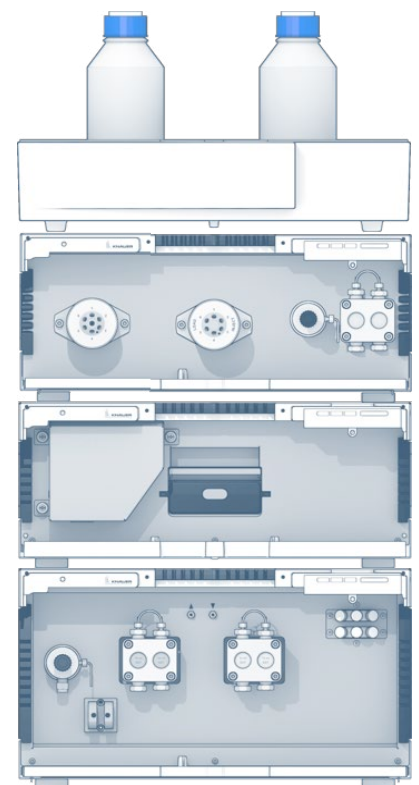
An AZURA® Bio purification system consisting of an AZURA P 6.1L HPG metal-free pump, AZURA ASM 2.1L assistant module 6 port/3 channel injection valve and a 6 port multi position fraction valve, an AZURA MWD 2.1L multi wavelength detector with semi-preparative biocompatible 3 mm, 2 µL flow cell cartridge was used. A Tricorn™ 10/200 column was filled with Chelating Sepharose™ Fast Flow to a column volume of 15 mL. The column was equilibrated with 50 mM NaOAc, pH 5.0 and loaded with nickel ions by applying 0.5 column volume 50 mM NaOAc, 100 mM NiSO<sub>4</sub>, pH 5.0. Unbound ions were washed out with 50 mM NaOAc, pH 5.0. Sulfhydryl-Oxidase was over expressed in *Bacillus subtilis*. After cultivation the fermentation broth was centrifuged for 30 min at 4300 x g for primary clarification purposes. The supernatant was 0.45 µm filtered, concentrated via ultrafiltration and subsequently used for the chromatographic purification. After applying the supernatant, the IMAC column was washed for 6 min at a flow rate of 3 mL/min with buffer A. Next, the target protein was eluted with 15 mL Buffer B and collected with the fraction valve. The column was re-equilibrated with buffer A. The UV signal was measured at 280 nm. The samples were analyzed for purity by SDS-PAGE.

## REFERENCES

[1] Trivedi, M. V., Laurence, J. S., & Siahaan, T. J. (2009). The role of thiols and disulfides on protein stability. *Current protein & peptide science*, 10(6), 614-625.

## CONCLUSION

Purification and concentration of SOx with the AZURA Bio purification system was successfully established. The recombinant His-tagged SOx was over-expressed in *Bacillus subtilis* and could be purified by IMAC from the fermentation supernatant. The availability of pure enzyme enables tests for further characterization of the target enzyme as well as precise identification of the SOx' potential in diverse food applications.



## ADDITIONAL MATERIALS AND METHODS

**Tab. A1** Method parameters

Eluent A	20 mM Na <sub>3</sub> PO <sub>4</sub> , 300 mM NaCl, 10 mM Imidazol, pH 7.4		
Eluent B	20 mM Na <sub>3</sub> PO <sub>4</sub> , 300 mM NaCl, 250 mM Imidazol, pH 7.4		
Gradient	Volume (mL)	% A	% B
	0	100	0
	18	100	0
	18.3	0	100
	33	0	100
	33.3	100	0
	60	100	0
Flow rate	3 mL/min	Detection wavelength	280 nm
Run temperature	RT	Run time	20 min
Injection volume	10 mL	Injection mode	Full loop

**Tab. A2** System configuration

Instrument	Description	Article No.
Pump	AZURA® P6.1L HPG 50 mL ceramic	<a href="#">APH68FB</a>
Assistent	AZURA® ASM 2.1L Right: 6P/Mpos 1/16" PEEK Middle: 6P/2Pos 1/16" PEEK Left: P4.1S 10 mL ceramic	
Detector	AZURA® MWD2.1L	<a href="#">ADB01</a>
Flow cell	3 mm path length, 1/16", 2 µL volume, 300 bar, biocompatible	<a href="#">AMB18</a>
Column	Tricorn™ 10/200 Säule, Chelating Sepharose™ Fast Flow	
Software	Purity Chrom Bio	<a href="#">A2650</a>

## RELATED KNAUER APPLICATIONS

[VBS0063](#) - Automated two step purification of mouse antibody IgG1 with AZURA Bio purification system

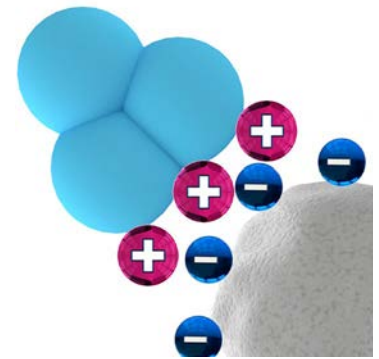
[VBS0064](#) - Comparison of IgG purification by two different protein A media

[VBS0067](#) - Automated two step purification of 6xHis-tagged GFP

[VBS0066](#) - Fast and sensitive size exclusion chromatography of IgG antibody

# Ion Exchange Chromatography with AZURA® Bio purification system

Ulrike Krop, Kate Monks; [applications@knauer.net](mailto:applications@knauer.net)  
KNAUER Wissenschaftliche Geräte GmbH, Hegauer Weg 38, 14163 Berlin; [www.knauer.net](http://www.knauer.net)



## SUMMARY

Ion exchange chromatography is a popular technique for protein separation and purification. This application describes the separation of three model proteins by a salt gradient with the AZURA® Bio purification system.

## INTRODUCTION

Ion exchange chromatography separates molecules based on the overall charge of the protein. The proteins of interest have a charge opposite to that of the resin. In the case of cation exchange chromatography, proteins have an overall negative charge while binding to a cationic column (Fig 1). The initial binding takes place under low ionic strength conditions. Elution is achieved by a salt gradient. By increasing the salt concentration proteins with a weak negative

charge elute first, while at higher salt concentrations proteins with a strong negative charge elute later. Ion exchange chromatography is frequently used for protein purification. A precise gradient formation is here one important parameter for a successful separation of proteins. AZURA Bio purification system supports all gradient methods including ion exchange chromatography.



# Ion Exchange Chromatography with AZURA® Bio purification system

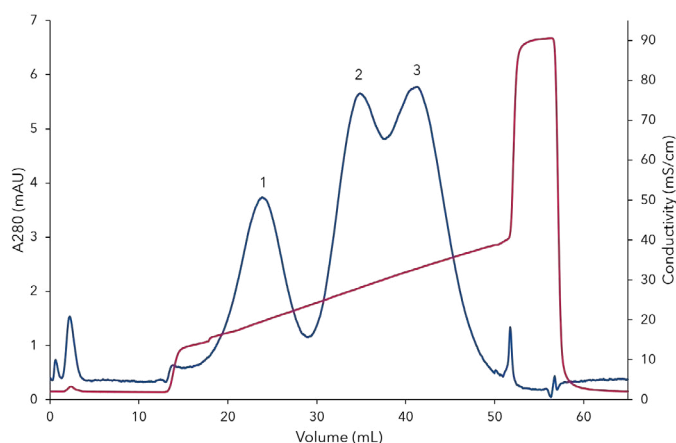
## RESULTS

Because of their isoelectric point (pI) the three proteins:  $\alpha$ -Chymotrypsinogen A (pI 8.97), Cytochrome C (pI range from 10.0 - 10.5), and Lysozyme (pI 11.35) are well suited for the separation by cation exchange chromatography. At pH 6.1 all three model proteins have an overall negative charge and bind to the resin under low salt conditions. Remaining impurities and

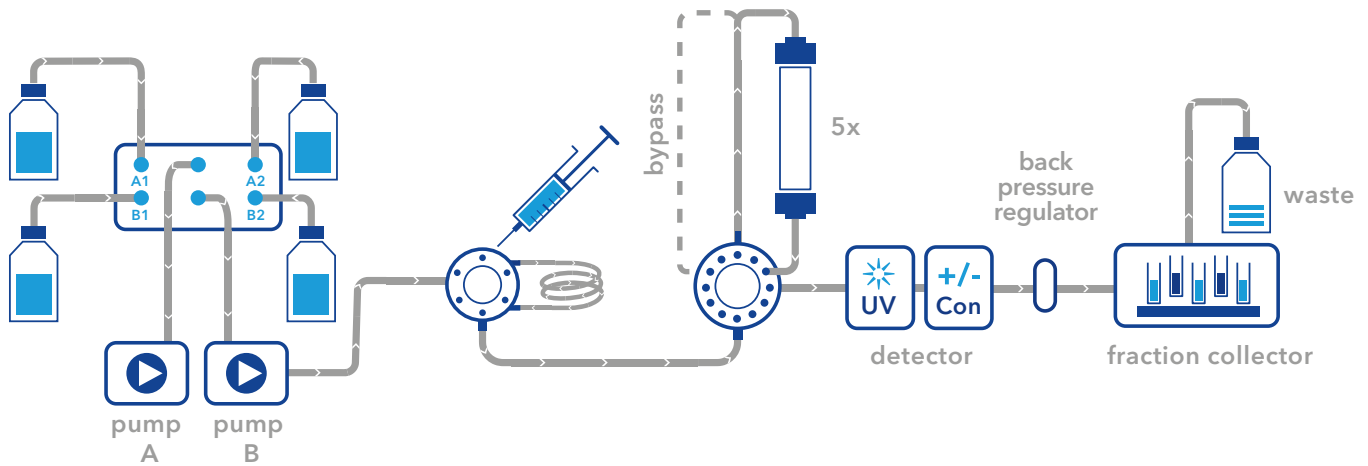
potentially unbound proteins are washed from the column during the wash step. By slowly increasing the salt gradient, first  $\alpha$ -Chymotrypsinogen A (**Fig 2** blue signal, Peak 1) eluted from the column followed by Cytochrome C (Peak 2) and Lysozyme (Peak 3). The salt gradient was monitored by the conductivity monitor (**Fig 2** red signal).



**Fig. 1** Principle of cation exchange separation. Proteins with different negative charges bind to the cation exchange resin. By increasing the salt concentration, proteins with a weak negative charge elute first, while at higher salt concentrations, proteins with a strong negative charge elute last.



**Fig. 2** Chromatogram of the separation of three model proteins with cation exchange chromatography, blue line - UV 280 nm signal, red line - conductivity signal, 1) peak containing  $\alpha$ -Chymotrypsinogen A, 2) peak containing Cytochrome C, 3) peak containing Lysozyme.



**BUFFER SELECTION  
& DELIVERY**

**SAMPLE  
INJECTION**

**COLUMN  
SELECTION**

**DETECTION**

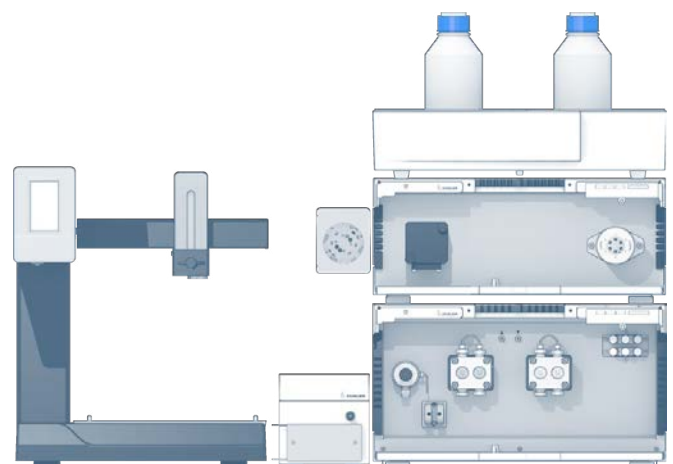
**FRACTION  
COLLECTION**

## MATERIALS AND METHODS

In this application, an AZURA® Bio purification system consisting of AZURA P 6.1L HPG metal-free pump with 50 ml pump head; AZURA ASM 2.1L assistant module with UVD 2.1S detector and an injection valve; a bioinert multifunction selection valve; AZURA CM 2.1S conductivity monitor and Foxy R1 fraction collector was used. Prior to the run the cation exchange column (Sepapure SP FF6 1 mL) was equilibrated with buffer A (20 mM sodium phosphate buffer pH 6.1). The flowrate for the run was 1 mL/min. 100 µL protein mixture ( $\alpha$ -Chymotrypsinogen A 0.33 mg/mL, Cytochrome C 0.33 mg/ml, Lysozyme 0.33 mg/mL) was injected. The column was washed with 5 mL buffer A to remove all unbound protein. The proteins were eluted with a linear gradient from 10% buffer B (20 mM sodium phosphate buffer pH 6.1, 1 M NaCl) to 40% B for 20 mL. The column was regenerated with a high salt wash of 5 mL buffer B 100% followed by a re-equilibration of the column with 10 mL of buffer A at a flowrate of 2 mL/min. The proteins were detected at 280 nm and conductivity signal was recorded to monitor the salt gradient.

## CONCLUSION

The principle of ion exchange chromatography was illustrated. Three model proteins eluted under increasing salt concentrations from the cation exchange column. The AZURA Bio purification system is well suited for all gradient methods like ion exchange, hydrophobic interaction and reversed phase chromatography. Isocratic methods like size exclusion and affinity chromatography are as well supported. AZURA Bio purification system is the ideal system for your protein purification task.



## ADDITIONAL MATERIALS AND METHODS

**Tab. A1** Method parameters

Eluent A	20 mM Sodium phosphate buffer pH 6.1		
Eluent B	20 mM Sodium phosphate buffer pH 6.1 + 1M NaCl		
Gradient	Volume [mL]	% A	% B
	0-5 step	100	0
	5-25 gradient	90	10
		60	40
	25-30 step	0	100
30-40 step	100	0	
Flow rate	1 mL/min from 25 mL: 2 mL/min	System pressure	0-1 bar
Column temperature	RT	Run time	40 min
Injection volume	100 µL	Injection mode	Injection valve
Detection UV	280 nm	Data rate	2 Hz

**Tab. A2** System configuration

Instrument	Description	Article No.
Pump	AZURA P6.1L, HPG 50 mL	<a href="#">APH68FB</a>
Assistant	AZURA ASM 2.1 L Left: UVD 2.1S Middle: - Right: 6-Port 2-Pos 1/16", PEEK	<a href="#">AYCALXEC</a>
Valve	Bioinert multifunction selection valve	<a href="#">AWB00FC</a>
Flow cell	Semi-preparative, UV Flow cell, 3mm, 1/16", 2 µL volume, biocompatible	<a href="#">A4045</a>
Conductivity monitor	AZURA CM 2.1S	<a href="#">ADG30</a>
Flow cell	Preparative up to 100 mL/min	<a href="#">A4157</a>
Column	Sepapure SP FF6 1 mL	<a href="#">010X15RSPZ</a>
Fraction collector	Foxy R1	<a href="#">A59100</a>
Software	Purity Chrom Basic	<a href="#">A2650</a>

## RELATED KNAUER APPLICATIONS

[VBS0063](#) - Automated two - step purification of mouse antibody IgG1

[VBS0064](#) - Comparison of IgG purification by two different protein A media

[VBS0067](#) - Automated two-step purification of 6xHis-tagged GFP

[VBS0069](#) - Purification of Sulfhydryl Oxidase

[VBS0071](#) - Comparison of two column sets for antibody purification in an automated two step purification process

[VBS0072](#) - Separation of proteins with cation exchange chromatography on Sepapure SP and CM

[VBS0073](#) - Separation of proteins with anion exchange chromatography on Sepapure Q and DEAE

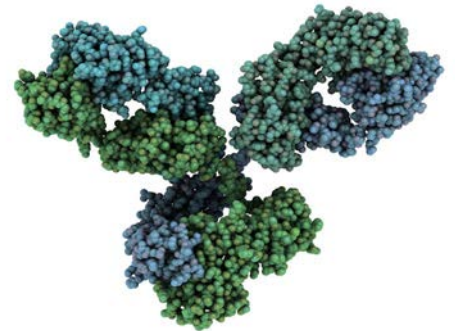
[VBS0074](#) - Comparison of ion exchange columns

[VBS0075](#) - Group separation with Sepapure Desalting on AZURA Bio purification system



# Comparison of two column sets for antibody purification in an automated two step purification process

Ulrike Krop, Kate Monks; [applications@knauer.net](mailto:applications@knauer.net)  
KNAUER Wissenschaftliche Geräte GmbH, Hegauer Weg 38, 14163 Berlin;  
[www.knauer.net](http://www.knauer.net)



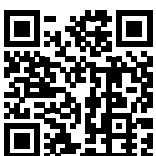
## SUMMARY

This application compares the automated purification of antibodies with the AZURA® Bio purification 50 – Two Step Purification System with different columns. Capacity and yield of the purified proteins were compared and revealed no significant differences in the performances of the two investigated column sets.

## INTRODUCTION

Antibodies play an important role in the biotechnology and pharmaceutical industry. They are used in a variety of applications where quality and purity of the antibodies is crucial. The most widely used technique for antibody purification is protein A affinity chromatography. It is a very efficient capture step and delivers highly clean protein. The antibodies are eluted under acidic conditions requiring an additional buffer exchange step. This desalting step requires in many

cases manual interaction. The AZURA Bio purification 50 – Two Step Purification System allows an automated purification without manual interaction. Various resins from different vendors are available for protein A affinity and desalting purification. The aim of this application was to compare different column sets for the affinity and desalting phase for this specific two step approach.

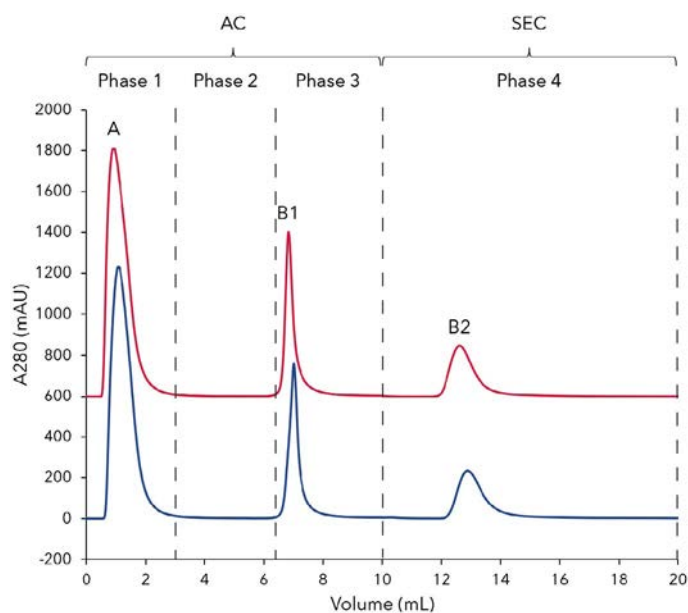


# Comparison of two column sets for antibody purification in an automated two step purification process

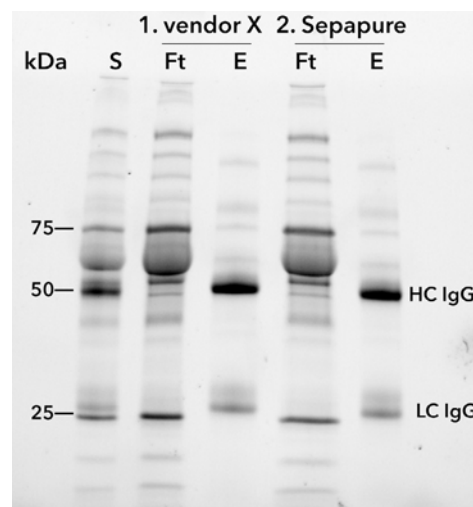
## RESULTS

Antibodies were purified from 100  $\mu$ L reconstituted human plasma by protein A affinity chromatography and a subsequent buffer exchange step. The chromatogram of the whole purification process is divided in two steps (Fig 1) During the first step, the sample is injected. All non-binding proteins flow through the column (Peak A). Next, all remaining impurities are washed from the affinity column. Elution takes place under low pH conditions (Peak B1). The eluted sample was stored in a sample loop and reinjected in step two on a desalting column. Finally, the elution peak (Peak B2) was collected. In the chromatogram two example

purifications with different column sets are depicted. The antibodies purified with the vendor X Protein A FF and Desalting columns (red signal) and Sepapure Protein A FF and Sepapure Desalting columns (blue signal) are comparable. An average of  $0.37 \pm 0.05$  mg proteins was purified with the vendor X Protein A FF and Desalting column in comparison to an average yield of  $0.41 \pm 0.1$  mg protein with Sepapure Protein A FF and Sepapure Desalting columns (Tab 1 suppl. Material). Finally, SDS-PAGE was performed to analyze the purity of the samples (Fig 2).



**Fig. 1** Overlay of chromatograms of the two step antibody purification; Step 1 - Affinity chromatography (AC): Phase 1) Sample injection; Phase 2) Column washing; Phase 3) Elution of antibodies and parking in sample loop; Step 2 - Buffer exchange with desalting column: Phase 4) Elution of antibody; A - flow through of unbound protein; B1 - elution peak of antibodies from Protein A column; B2 - elution peak of antibodies from desalting column; Red signal : Purification with vendor X Protein A FF 1 mL and Desalting 5 mL column Blue signal: Purification with Sepapure Protein A FF 1 mL and Sepapure Desalting 5 mL column



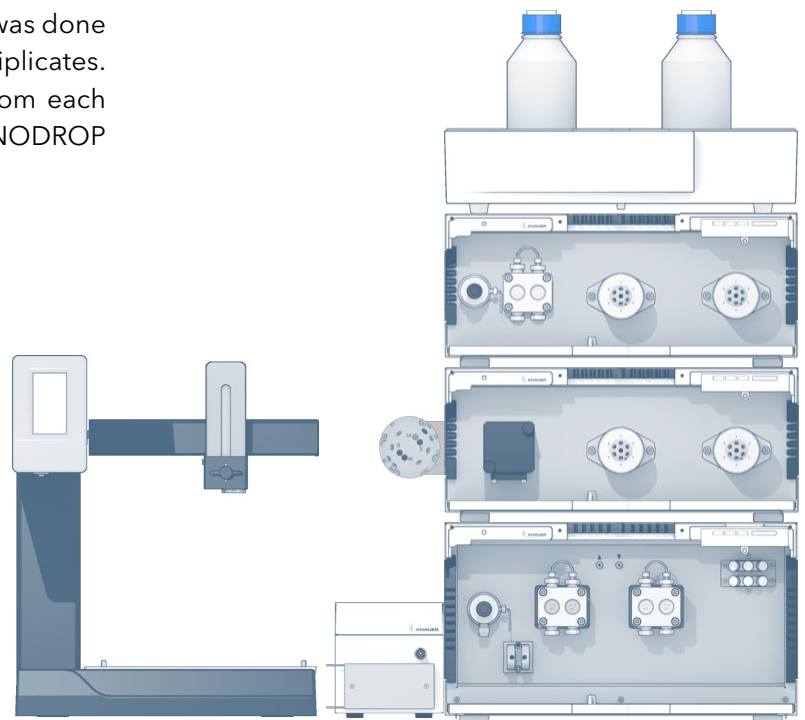
**Fig. 2** SDS-PAGE at different purification steps; 1. Purification with vendor X Protein A FF 1 mL and Desalting 5 mL column, 2. Purification with Sepapure Protein A FF 1 mL and Sepapure Desalting 5 mL column, S) serum before purification; Ft) flow through, E) eluted antibodies (IgG) heavy chain (HC) and light chain (LC) after two step purification

## MATERIALS AND METHODS

In this application an AZURA Bio purification 50 - Two Step Purification System was used. It consisted of an AZURA P 6.1L 50 mL HPG metal-free pump, 1st AZURA ASM 2.1L assistant module with 50 mL feed pump and two 6 port/2 position valves, 2nd AZURA ASM 2.1L with UVD 2.1S and two 6 port/2 position valves, column switching valve; conductivity monitor and a fraction collector. The protein A and Desalting columns were equilibrated with buffer A (20 mM Sodium Phosphate Buffer, pH 7.4). The flowrate for the 1 mL protein A columns was 1 ml/min and for the 5 mL Desalting columns was 5 mL/min. 100  $\mu$ L of reconstituted human plasma was injected on to the protein A column. The column was washed with buffer A. Antibodies were eluted with buffer B (0.1 M Glycin-HCL, pH 2.7). Via a threshold function the elution peak was parked in a 5 mL sample loop. Subsequently, the eluted protein was re-injected on to the desalting column for buffer exchange with buffer A. The eluted antibodies were collected with the fraction collector. The UV signal was measured at 280 nm and conductivity signal was recorded. Each purification was done with two column sets from each vendor in triplicates. The concentrations of the eluted protein from each individual run were determined with a NANODROP 2000 and analyzed by SDS-PAGE.

## CONCLUSION

The AZURA Bio purification 50 - Two Step Purification System was used to analyze the automatic purification of human antibodies with two different sets of columns from different vendors. The yield and purity of the eluted antibodies was for both column sets comparable. With the two step purification system, no manual interaction was necessary between the first protein A affinity chromatography step and the second buffer exchange/desalting step. This setup can be adapted to other purification protocols and can be used for a variety of materials. In conclusion, the purification is quantitatively and qualitatively identical for both tested column materials in the two step system setup. The tested column materials are suitable for two step purification.



## ADDITIONAL RESULTS

Tab.A1 Yield of the purified antibodies

Column set	Repetition	Protein A Column	Desalting column	Yield in mg	Mean
1	1	vondor X Protein A FF 1 mL	vondor X Desalting 5 mL	0.38	0.37 ±0.05
	2			0.40	
	3			0.45	
2	1	Sepapure Protein A FF 1 mL	Sepapure Desalting 5 mL	0.33	0.41 ±0.10
	2			0.32	
	3			0.36	
1	1	vondor X Protein A FF 1 mL	vondor X Desalting 5 mL	0.63	0.41 ±0.10
	2			0.38	
	3			0.38	
2	1	Sepapure Protein A FF 1 mL	Sepapure Desalting 5 mL	0.34	0.41 ±0.10
	2			0.34	
	3			0.41	

## ADDITIONAL MATERIALS AND METHODS

Tab.A2 Method parameters

Eluent A	20 mM Sodium phosphate buffer pH 7.4		
Eluent B	100 mM Glycine, pH 2.7		
Gradient	Volume [mL]	% A	% B
AC Injection+Wash	0-5	100	0
AC Elution	5.02-10	0	100
SEC/Desalting	10.02-20	100	0
Flow rate	1 mL/min (Protein A) 5 mL/min (Desalting)	System pressure >3 bar	
Run temperature	RT	Run time	12 min
Injection volume	100 µL	Injection mode	Injection valve
Detection UV	280 nm	Data rate	2 Hz

Tab.A3 System configuration

Instrument	Description	Article No.
Pump	AZURA P6.1L, HPG 50 mL pump head, ceramic	<a href="#">APH68FB</a>
Assistant 1	AZURA ASM 2.1 L Right: 6 Port 2 Pos valve 1/16", PEEK Middle: 6 Port 2 Pos valve 1/16", PEEK Left: P 4.1S, 50 mL pump head, ceramic	<a href="#">AYBLECEC</a>
Assistant 2	AZURA ASM 2.1 L Right: 6 Port 2 Pos valve 1/16", PEEK Middle: 6 Port 2 Pos valve 1/16", PEEK Left: UVD2.1S	<a href="#">AYCAECEC</a>
Flow cell	3 mm path length, 1/16", 2 µL volume, 300 bar, biocompatible	<a href="#">A4045</a>
Conductivity monitor	AZURA CM 2.1S	<a href="#">ADG30</a>
Flow cell	Preparative up to 100 mL/min	<a href="#">A4157</a>
Column	Sepapure Protein A FF 1ml Sepapure Desalting 5 ml vondor X Protein A FF, 1ml vondor X Desalting, 5 ml	<a href="#">010X40USPZ</a> <a href="#">020X46OSPZ</a>
Fraction collector	Foxy R1, microplates rack	<a href="#">A59100</a>
Software	Purity Chrom Basic	<a href="#">A2650</a>

## RELATED KNAUER APPLICATIONS

[VBS0063](#) - Automated two - step purification of mouse antibody IgG1

[VBS0064](#) - Comparison of IgG purification by two different protein A media

[VBS0067](#) - Automated two step purification of 6xHis-tagged GFP

[VBS0070](#) - Ion Exchange Chromatography with AZURA® Bio purification system

# Separation of proteins with cation exchange chromatography on Sepapure SP and CM

Ulrike Krop, Kate Monks; [applications@knauer.net](mailto:applications@knauer.net)  
KNAUER Wissenschaftliche Geräte GmbH, Hegauer Weg 38, 14163 Berlin; [www.knauer.net](http://www.knauer.net)



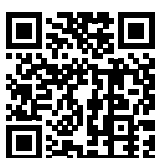
## SUMMARY

Ion exchange chromatography is one of the most widely used FPLC techniques for protein separation and purification. Depending on the charge of the sample and the resin cation or anion exchange chromatography is used. This application describes an easy separation of model proteins and explains how cation exchange chromatography works.

## INTRODUCTION

Ion exchange chromatography separates molecules according to type and strength of their charge. The isoelectric point (pI) is the pH where a protein or molecule has no net electrical charge. Depending on the pH of the buffer a protein has different surface charges in solution. At a pH below their pI proteins have positive charge and bind to negatively charged cation exchangers **Fig 1**). This interaction is used for the separation and purification of various proteins. By using a suitable pH and low salt conditions proteins bind to the resin in the initial step. Proteins are mostly separated with a linear salt gradient whereby the salt ions compete with the proteins for bindings sites. Proteins with weak ionic interactions are the first to elute from the column. In the case of cation exchange

chromatography, proteins that are less positively charged start to elute first. With an increase of the salt concentration proteins with stronger ionic interaction elute later from the column. Ion exchange resins are categorized as strong or weak exchangers. Strong ion exchange resins are fully charged over a wide range of pH levels, while weak ion exchangers have depending on the pH varying ion exchange capacity. Weak ion exchangers have different selectivity's compared to strong ion exchangers. This application describes the separation of Cytochrome C, Lysozyme, and Ribonuclease A on a weak and a strong cation exchanger and explains the principle of cation exchange chromatography.



# Separation of proteins with cation exchange chromatography on Sepapure SP and CM

## RESULTS

Cytochrome C (pI 10.3), Lysozyme (pI 11.35), and Ribonuclease A (pI 9.6) are proteins with relatively high pI values, which make them ideal candidates for cation exchange chromatography (Fig 2). All three proteins bind under low salt conditions to the resin. Ribonuclease A eluted first from the column due to its lower pI of 9.6 (Fig 2, peak 1). With an increasing gradient and

therefore increasing salt concentration Cytochrome C eluted as second peak while Lysozyme eluted as third peak. The identical protein mix was run on a weak (light blue signal Sepapure CM) and strong (dark blue signal Sepapure SP) cation exchangers showing the different selectivity of these two resins.

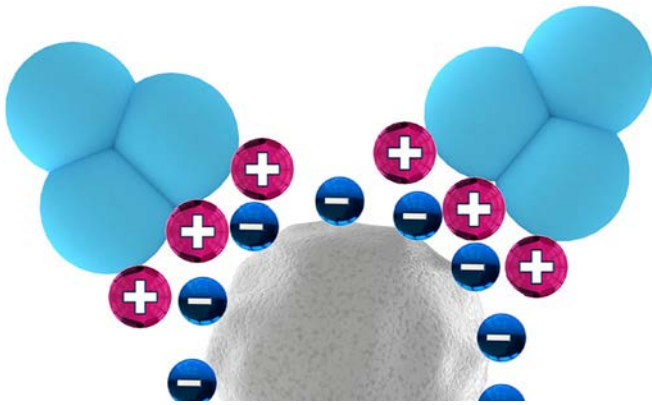


Fig. 1 Principle of cation exchange chromatography

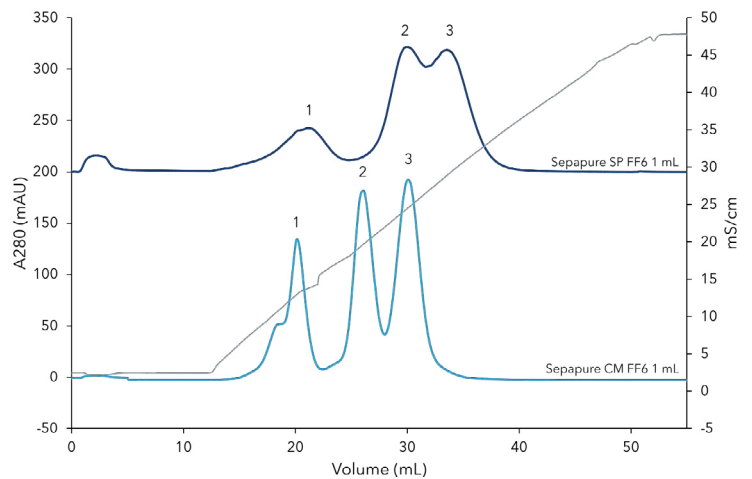


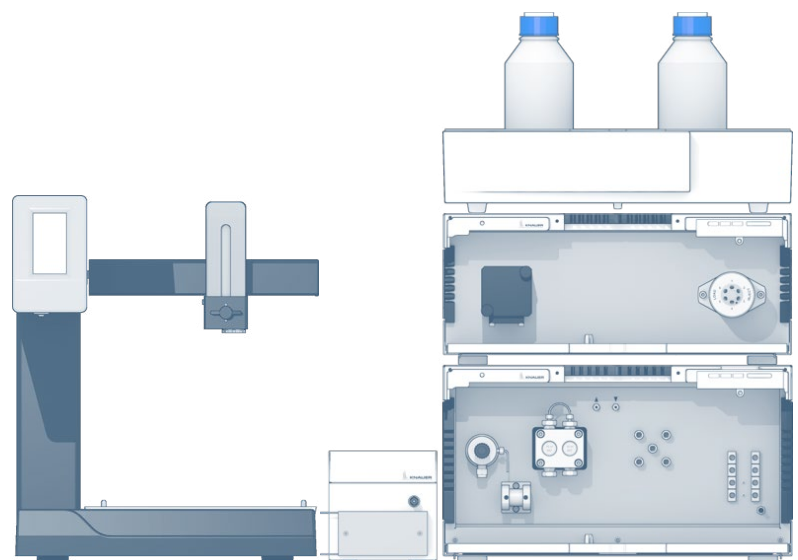
Fig. 2 Chromatograms of the separation of Ribonuclease A (1), Cytochrome C (2), and Lysozyme (3) with weak (light blue line) and strong (dark blue line) cation exchange chromatography columns, grey line: conductivity signal

## MATERIALS AND METHODS

In this application, an AZURA® Bio purification system consisting of AZURA P 6.1L LPG metal-free pump with 10 mL pump head; AZURA ASM 2.1L assistant module with an injection valve and a single wavelength UV detector UVD 2.1S; AZURA CM 2.1S conductivity monitor and Foxy R1 fraction collector was used. Cytochrome C (0.4 mg/mL), Lysozyme (0.4 mg/mL) and Ribonuclease A (1 mg/mL) were diluted and mixed in buffer A (20 mM Sodium phosphate buffer pH 6.8) to the final concentration. Prior to the run the cation exchange columns (Sepapure SP FF6 1 mL and Sepapure CM FF6 1 mL) were equilibrated with buffer A. 2 ml of the sample was injected with a flowrate of 1 ml/min. The column was washed with 10 column volume (CV) of buffer A to remove all unbound protein. The proteins were eluted with a linear gradient over 40 CV up to 50 % buffer B (20 mM Sodium phosphate buffer pH 6.8, 1 M NaCl). The proteins were detected at 280 nm and conductivity signal was recorded to monitor the salt gradient.

## CONCLUSION

Three model proteins with different surface charges eluted under increasing salt concentrations from the cation exchange columns illustrating the principle of cation exchange chromatography. The application demonstrates the different selectivity of Sepapure CM, a weak, and Sepapure SP, a strong, cation exchange column.



## ADDITIONAL MATERIALS AND METHODS

**Tab. A1** Method parameters

Eluent A	20 mM Sodium phosphate buffer pH 6.8		
Eluent B	20 mM Sodium phosphate buffer pH 6.8 + 1 M NaCl		
Gradient	Volume [mL]	% A	% B
	10 step	100	0
	40 gradient	50	50
	5 step	50	50
Flow rate	10 step	100	0
	1 mL/min (2 mL/min from 50 mL)	System pressure	>3 bar
Run temperature	RT	Run time	57.5 min
Injection volume	2 mL	Injection mode	Automatic injection valve
Detection UV	280 nm	Data rate	2 Hz

**Tab. A2** System configuration

Instrument	Description	Article No.
Pump	AZURA P6.1L, LPG 10 mL PEEK PK	<a href="#">APH69EB</a>
Assistant	AZURA ASM 2.1L Right: UVD 2.1S Middle: - Left: V2.1S 6 Port/6 Position PEEK 1/16"	<a href="#">AYCALXEC</a>
Flow cell	3 mm semiprep, 2 µL, biocompatibel	<a href="#">A4045</a>
Conductivity monitor	AZURA CM 2.1S	<a href="#">ADG30</a>
Flow cell	Preparative up to 100 mL/min	<a href="#">A4157</a>
Column	Sepapure SP FF6 1ml Sepapure CM FF6 1ml	<a href="#">010X15RSPZ</a>
		<a href="#">010X15QSPZ</a>
Fraction collector	Foxy R1	<a href="#">A2650</a>
Software	Purity Chrom	<a href="#">A59100</a>

## RELATED KNAUER APPLICATIONS

[VBS0070](#) - Ion Exchange Chromatography with AZURA® Bio purification system

[VBS0071](#) - Comparison of two column sets for antibody purification in an automated two step purification process

[VBS0073](#) - Separation of proteins with anion exchange chromatography on Sepapure Q and DEAE

[VBS0074](#) - Comparison of ion exchange columns



# Separation of proteins with anion exchange chromatography on Sepapure Q and DEAE

Ulrike Krop, Kate Monks; applications@knauer.net

KNAUER Wissenschaftliche Geräte GmbH, Hegauer Weg 38, 14163 Berlin; www.knauer.net

## SUMMARY

Ion exchange chromatography is one of the most widely used FPLC techniques for protein separation and purification. Depending on the charge of the sample and the resin cation or anion exchange chromatography is used. This application describes an easy separation of model proteins and explains how anion exchange chromatography works.

## INTRODUCTION

Ion exchange chromatography separates molecules according to type and strength of their charge. The isoelectric point (pI) is the pH where a protein or molecule has no net electrical charge. Depending on the pH of the buffer a protein has different surface charges in solution. At a pH above their pI proteins have a negative charge and bind to positively charged resins such as anion exchangers (**Fig 1**). This interaction is used for the separation and purification of various proteins. By using a suitable pH and low salt conditions proteins bind to the resin in the initial step. Proteins are mostly separated with a linear salt gradient whereby the salt ions compete with the proteins for binding sites. Proteins with weak ionic interactions are the first to elute from the column. In the case of anion exchange chromatography, proteins that are less negatively charged start to elute first. With an increase of the salt concentration proteins with stronger ionic interaction elute later from the column. Ion exchange resins are categorized as strong or weak exchangers. Strong ion exchange resins are fully charged over a wide range

of pH levels, while weak ion exchangers have depending on the pH varying ion exchange capacity. Weak ion exchangers have different selectivities compared to strong ion exchangers. This application describes the separation of Conalbumin,  $\alpha$ -Lactoglobulin and soy bean Trypsin inhibitor on a weak and a strong anion exchanger and explains the principle of anion exchange chromatography.



Fig. 1 Principle of anion exchange chromatography



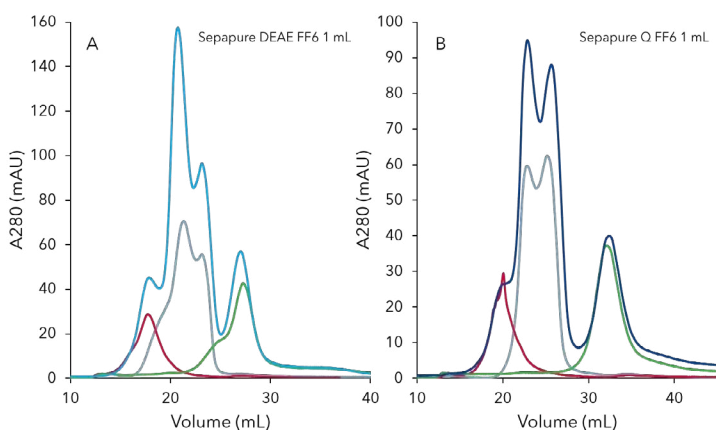
# Separation of proteins with anion exchange chromatography on Sepapure Q and DEAE

## RESULTS

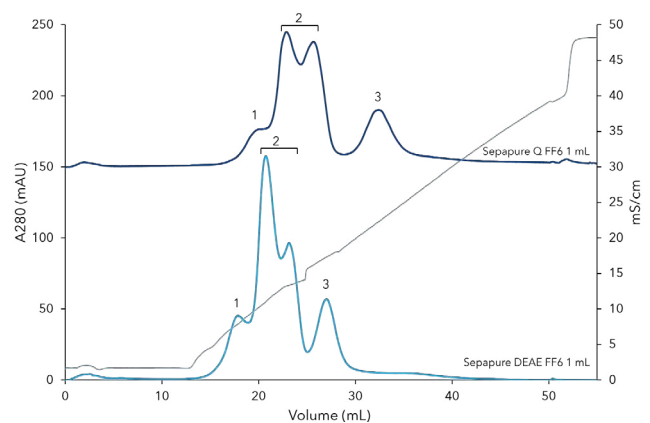
Conalbumin (pI 6.8),  $\alpha$ -Lactoglobulin (pI 5.8), and soy bean Trypsin inhibitor Cytochrome C se A (pI 4.5) are proteins with relatively low pI values, which make them ideal candidates for anion exchange chromatography (Fig 2 & 3). All three proteins bind under low salt conditions to the resin. Conalbumin A eluted first from the column due to its highest pI within the group of separated proteins. With an increasing gradient and therefore increasing salt concentration  $\alpha$ -Lactalbumin

eluted as second peak while soy bean Trypsin inhibitor eluted as third peak. The single protein standards were separated on each column to assign the peaks (Fig 2. A & B).

The identical protein mix was run on a weak (light blue signal Sepapure DEAE) and strong (dark blue signal Sepapure Q) anion exchangers showing the different selectivity of these two resins.



**Fig. 2** Overlay of chromatograms on weak (A) and strong (B) anion exchange chromatography columns. Conalbumin (red line),  $\alpha$ -Lactalbumin (grey line) and soy bean Trypsin inhibitor (green line), sample mix light blue for weak (A) and dark blue for strong (B) anion exchange chromatography columns



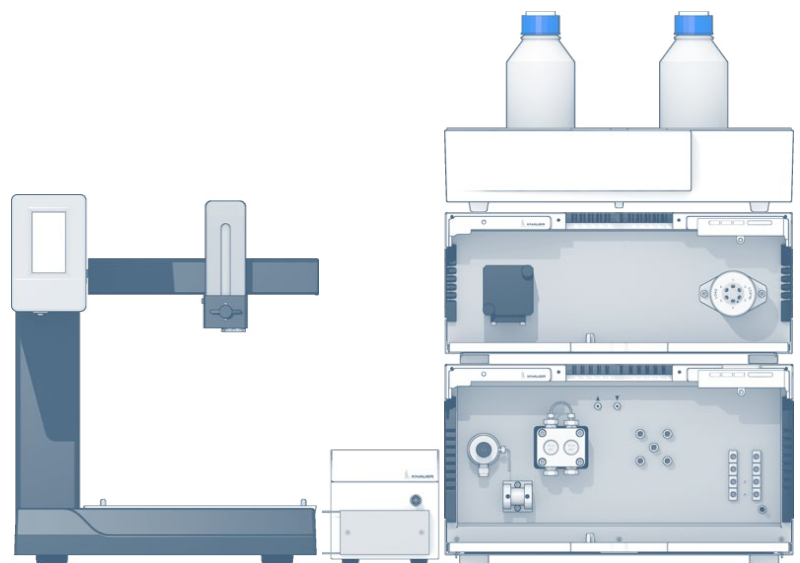
**Fig. 3** Chromatograms of the separation of Conalbumin (1),  $\alpha$ -Lactalbumin (2) and soy bean Trypsin inhibitor (3) with weak (light blue line) and strong (dark blue line) anion exchange chromatography columns, grey line: conductivity signal

## MATERIALS AND METHODS

In this application, an AZURA Bio LC system consisting of AZURA P 6.1L LPG metal-free pump with 10 ml pump head; AZURA ASM 2.1L assistant module with an injection valve and a single wavelength UV detector UVD 2.1S; AZURA CM 2.1S conductivity monitor and Foxy R1 fraction collector was used. Conalbumin (0.2 mg/mL),  $\alpha$ -Lactalbumin (0.4 mg/mL) and soy bean Trypsin inhibitor (0.6 mg/mL) were diluted and mixed in buffer A (20 mM Tris/HCl pH 7.4) to the final concentration. Prior to the run the anion exchange columns (Sepapure Q FF6 1 mL and Sepapure DEAE FF6 1 mL) were equilibrated with buffer A. 2 ml of the sample was injected with a flowrate of 1 ml/min. The column was washed with 10 column volume (CV) of buffer A to remove all unbound protein. The proteins were eluted with a linear gradient over 40 CV up to 40% buffer B (20 mM Tris/HCl pH 7.4, 1 M NaCl). The proteins were detected at 280 nm and conductivity signal was recorded to monitor the salt gradient.

## CONCLUSION

Three model proteins with different surface charges eluted under increasing salt concentrations from the anion exchange columns illustrating the principle of anion exchange chromatography. The application demonstrates the different selectivity of Sepapure DEAE, a weak, and Sepapure Q, a strong, anion exchange resin.



## ADDITIONAL MATERIALS AND METHODS

**Tab. A1** Method parameters

Eluent A	20 mM Tris/HCl pH 7.4		
Eluent B	20 mM Tris/HCl pH 7.4 + 1 M NaCl		
Gradient	Volume [mL]	% A	% B
	10 step	100	0
	40 gradient	60	40
	5 step	50	50
	10 step	100	0
Flow rate	1 mL/min	System pressure	>3 bar
Run temperature	RT	Run time	~60 min
Injection volume	2 mL	Injection mode	Automatic injection valve
Detection UV	280 nm	Data rate	2 Hz

**Tab. A2** System configuration

Instrument	Description	Article No.
Pump	AZURA P6.1L, LPG 10 mL PEEK PK	<a href="#">APH69EB</a>
Assistant	AZURA ASM 2.1L Right: UVD 2.1S Middle: - Left: V2.1S 6 Port/6 Position PEEK 1/16"	<a href="#">AYCALXEC</a>
Flow cell	3 mm semiprep, 2 µL, biocompatibel	<a href="#">A4045</a>
Conductivity monitor	AZURA CM 2.1S	<a href="#">ADG30</a>
Flow cell	Preparative up to 100 mL/ min	<a href="#">A4157</a>
Column	Sepapure Q FF6 1ml	<a href="#">010X15HSPZ</a>
	Sepapure DEAE FF6 1ml	<a href="#">010X15ISPZ</a>
Fraction collector	Foxy R1	<a href="#">A2650</a>
Software	Purity Chrom	<a href="#">A59100</a>

## RELATED KNAUER APPLICATIONS

[VBS0070](#) - Ion Exchange Chromatography with AZURA® Bio purification system

[VBS0071](#) - Comparison of two column sets for antibody purification in an automated two step purification process

[VBS0072](#) - Separation of proteins with cation exchange chromatography on Sepapure SP and CM

[VBS0074](#) - Comparison of ion exchange columns

# Comparison of ion exchange columns

Ulrike Krop, Kate Monks; applications@knauer.net

KNAUER Wissenschaftliche Geräte GmbH, Hegauer Weg 38, 14163 Berlin; www.knauer.net

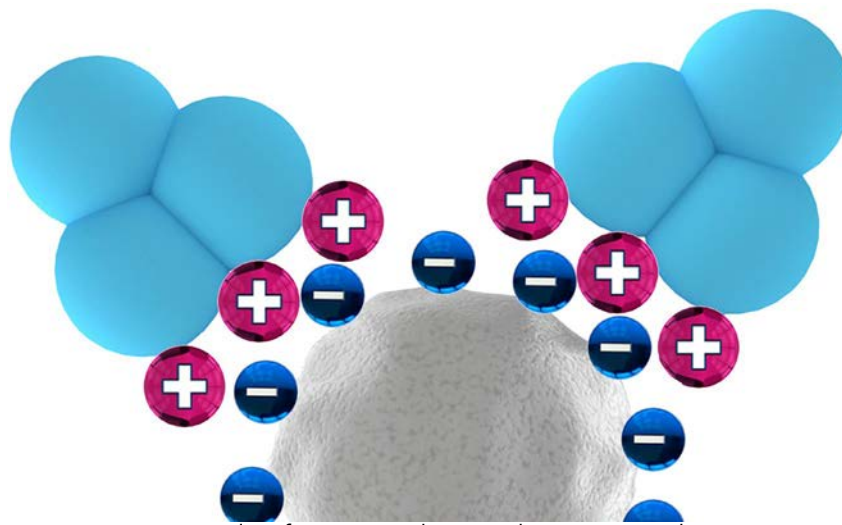
## SUMMARY

Ion exchangers are used in a variety of protein purification protocols. This application compares equivalent columns, a weak and a strong anion exchanger as well as a weak and a strong cation exchanger from two different vendors. The columns were comparable in all assessed cases.

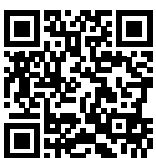
## INTRODUCTION

Ion exchange chromatography is a powerful technique to separate proteins and is therefore used in numerous purification protocols. The column resins are modified by covalently bound functional groups. The choice of column modification influences the selectivity of the column. According to the charge of

the protein cation or anion exchange chromatography is the best method. In this application equivalent columns with different modifications from two vendors were compared.



Principle of cation exchange chromatography

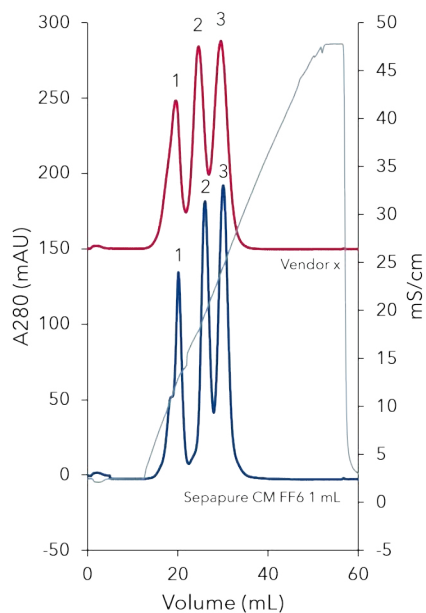


# Comparison of ion exchange columns

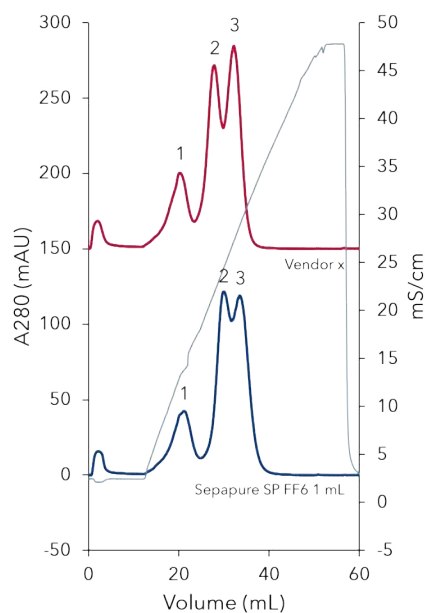
## RESULTS

Cytochrome C (pI 10.3), Lysozyme (pI 11.35) and Ribonuclease A (pI 9.6) are proteins with relatively high pI values, which make them ideal candidates for cation exchange chromatography (Fig 1 & 2) while for anion exchange chromatography Conalbumin (pI 6.8),  $\alpha$ -Lactalbumin (pI 5.8) and soy bean Trypsin inhibitor Cytochrome C (pI 4.5) were used (Fig 3 & 4). All sample mixes bound under low salt conditions to

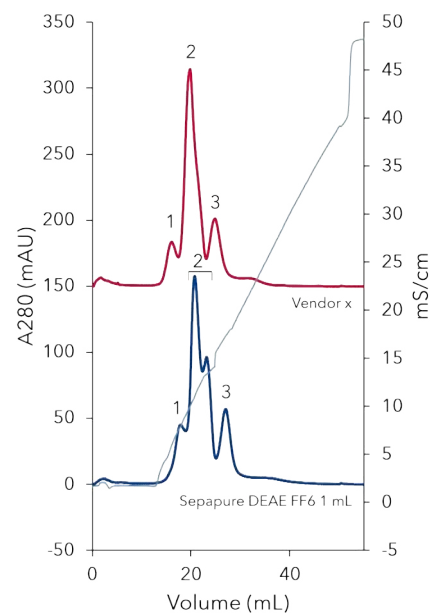
the resin and eluted under increasing salt concentrations. Identical protein mixes and method parameters were used for the comparison of the two vendors of weak and strong anion and cation exchangers. The peaks for the protein separation are comparable in all evaluated cases.



**Fig. 1** Chromatograms of the separation of Ribonuclease A (1), Cytochrome C (2), and Lysozyme (3) with weak cation exchange chromatography columns, blue line: Sepapure CM FF6 1 mL, red line: comparable column from vendor x, grey line: conductivity signal



**Fig. 2** Chromatograms of the separation of Ribonuclease A (1), Cytochrome C (2), and Lysozyme (3) with strong cation exchange chromatography columns, blue line: Sepapure SP FF6 1 mL, red line: comparable column from vendor x, grey line: conductivity signal



**Fig. 3** Chromatograms of the separation of Conalbumin (1),  $\alpha$ -Lactalbumin (2), and soy bean Trypsin inhibitor (3) with weak anion exchange chromatography columns, blue line: Sepapure DEAE FF6 1 mL, red line: comparable column from vendor x, grey line: conductivity signal

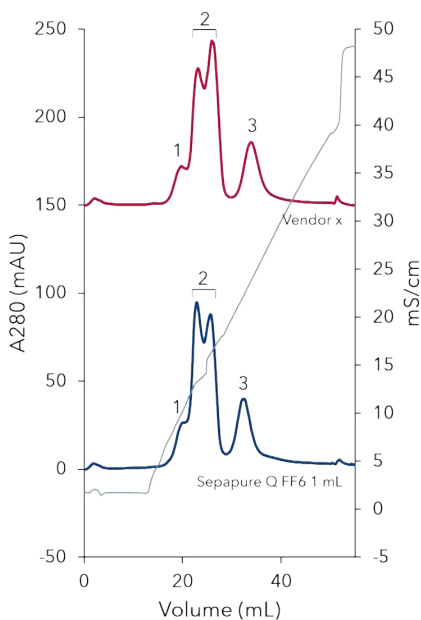
## MATERIALS AND METHODS

In this application, an AZURA Bio purification system consisting of AZURA P 6.1L LPG metal-free pump with 10 mL pump head; AZURA ASM 2.1L assistant module with an injection valve and a single wavelength UV detector UVD 2.1S; AZURA CM 2.1S conductivity monitor and Foxy R1 fraction collector was used. For cation exchangers a mix of Cytochrome C (0.4 mg/mL), Lysozyme (0.4 mg/mL), and Ribonuclease A (1 mg/mL) was used. For anion exchangers a mix of Conalbumin (0.2 mg/mL),  $\alpha$ -Lactalbumin (0.4 mg/mL), and soy bean Trypsin inhibitor (0.6 mg/mL) was used. Prior to the run the 1 mL columns (Sepapure SP, CM, Q, DEAE and the equivalent columns from vendor x)

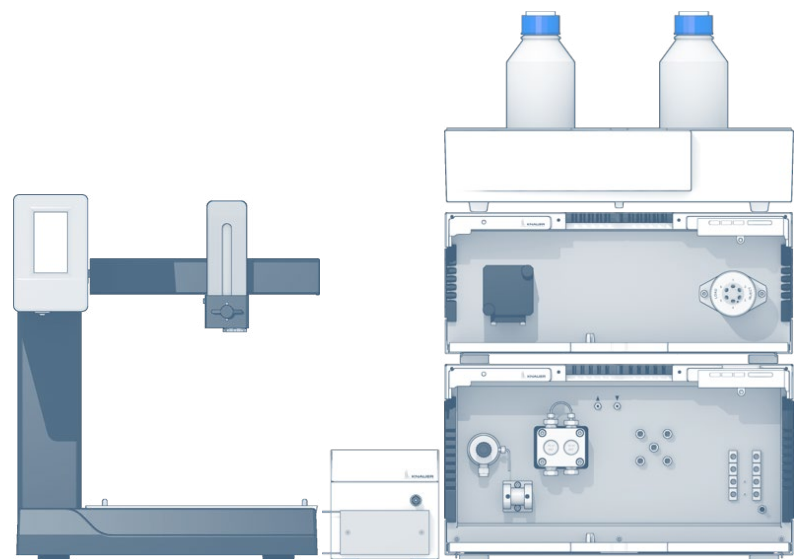
were equilibrated in buffer A (for cation exchangers: 20 mM Sodium phosphate buffer pH 6.8; for anion exchangers: 20 mM Tris/HCl pH 7.4). 2 mL of the sample was injected with a flowrate of 1 mL/min. The columns were washed with 10 column volume (CV) of buffer A to remove all unbound protein. The proteins were eluted with a linear gradient over 40 CV up to 50% buffer B (20 mM Sodium phosphate buffer pH 6.8, 1 M NaCl) for the cation exchangers or up to 40% buffer B (20 mM Tris/HCl pH 7.4, 1 M NaCl) for the anion exchangers. The proteins were detected at 280 nm and conductivity signal was recorded to monitor the salt gradient.

## CONCLUSION

Four different ion exchange columns types (SP, CM, Q, DEAE) from two vendors were compared. The equivalent columns were evaluated under identical conditions. The chromatograms of the protein separation are comparable in all assessed cases. The alternative columns can be considered as a replacement.



**Fig. 4** Chromatograms of the separation of Conalbumin (1),  $\alpha$ -Lactalbumin (2) and soy bean Trypsin inhibitor (3) with strong anion exchange chromatography columns, blue line: Sepapure Q FF6 1 mL, red line: comparable column from vendor x, grey line: conductivity signal



## ADDITIONAL MATERIALS AND METHODS

**Tab. A1** Method parameters for cation exchange chromatography runs

Eluent A	20 mM Sodium phosphate buffer pH 6.8		
Eluent B	20 mM Sodium phosphate buffer pH 6.8 + 1 M NaCl		
Gradient	Volume [mL]	% A	% B
	10 step	100	0
	40 gradient	50	50
	5 step	50	50
	10 step	100	0
Flow rate	1 mL/min (2 mL/min from 50 mL)	System pressure	>3 bar
Run temperature	RT	Run time	57.5 min
Injection volume	2 mL	Injection mode	Automatic injection valve
Detection UV	280 nm	Data rate	2 Hz

**Tab. A2** Method parameters for anion exchange chromatography runs

Eluent A	20 mM Tris/HCl pH 7.4		
Eluent B	20 mM Tris/HCl pH 7.4 + 1 M NaCl		
Gradient	Volume [mL]	% A	% B
	10 step	100	0
	40 gradient	60	40
	5 step	50	50
	10 step	100	0
Flow rate	1 mL/min	System pressure	>3 bar
Run temperature	RT	Run time	~60 min
Injection volume	2 mL	Injection mode	Automatic injection valve
Detection UV	280 nm	Data rate	2 Hz

**Tab. A3** System configuration

Instrument	Description	Article No.
Pump	AZURA P6.1L, LPG 10 mL PEEK PK	<a href="#">APH69EB</a>
Assistant	AZURA ASM 2.1L Right: UVD 2.1S Middle: - Left: V2.1S 6 Port/6 Position PEEK 1/16"	<a href="#">AYCALXEC</a>
Flow cell	3 mm semiprep, 2 µL, biocompatibel	<a href="#">A4045</a>
Conductivity monitor	AZURA CM 2.1S	<a href="#">ADG30</a>
Flow cell	Preparative up to 100 mL/min	<a href="#">A4157</a>
Column	Sepapure Q FF6 1mL	<a href="#">010X15HSPZ</a>
	Sepapure DEAE FF6 1mL	<a href="#">010X15ISPZ</a>
	Sepapure SP FF6 1mL	<a href="#">010X15RSPZ</a>
	Sepapure CM FF6 1mL	<a href="#">010X15QSPZ</a>
	vendor x Q FF 1mL	<a href="#">010X15QSPZ</a>
	vendor x DEAE FF 1mL	
	vendor x SP FF 1mL	
	vendor x CM FF 1mL	
Fraction collector	Foxy R1	<a href="#">A2650</a>
Software	Purity Chrom	<a href="#">A59100</a>

## RELATED KNAUER APPLICATIONS

[VBS0070](#) - Ion Exchange Chromatography with AZURA® Bio purification system

[VBS0071](#) - Comparison of two column sets for antibody purification in an automated two step purification process

[VBS0072](#) - Separation of proteins with cation exchange chromatography on Sepapure SP and CM

[VBS0073](#) - Separation of proteins with anion exchange chromatography on Sepapure Q and DEAE



# Group separation with Sepapure Desalting on AZURA® Bio purification system

Ulrike Krop, Kate Monks; applications@knauer.net

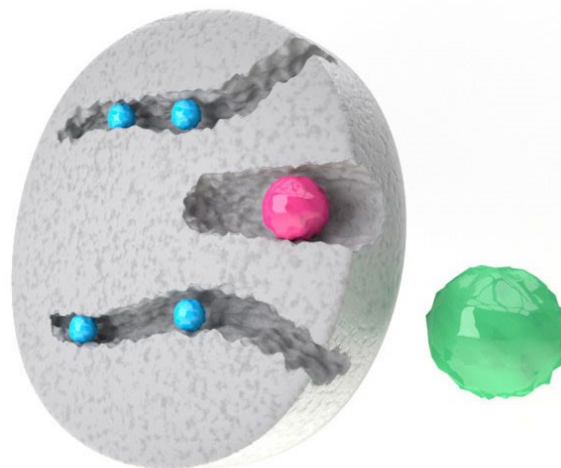
KNAUER Wissenschaftliche Geräte GmbH, Hegauer Weg 38, 14163 Berlin; www.knauer.net

## SUMMARY

Size exclusion chromatography (SEC) is a popular FPLC techniques used for protein purification. Molecules are separated according to their size. Depending on the aim of the purification high resolution fractionation or group separation is used. This application describes group separation with Sepapure Desalting and shows examples for the separation of proteins from dyes and for protein desalting.

## INTRODUCTION

Size exclusion chromatography (SEC) separates molecules according to their different molecular size. In comparison to other chromatography methods, in SEC the sample does not interact with the column matrix. The pore size of the SEC matrix allows the distribution of molecules of different sizes over the column bed and results in separation of the sample. Bigger molecules cannot enter the pores and pass through the column eluting first from the column. The smaller the molecules the better they can enter the pores and therefore have a longer way through the column resulting in a later retention time (**Fig 1**). SEC can be used for high resolution fractionation or group separation of molecules. In group separation the sample is separated into two groups: the high- and low-molecular weight fraction. Group separation can be used for protein purification to remove low molecular weight contaminations like dyes or for desalting and buffer exchange. Here, Fluorescein a popular fluorescent derivatization reagent used for labeling of biomolecules was removed after the labeling process by SEC. Another common use for SEC is desalting. Proteins of interest are not retained by the column and elute first. The small salt molecules elute later and



**Fig. 1** Principle of size exclusion chromatography

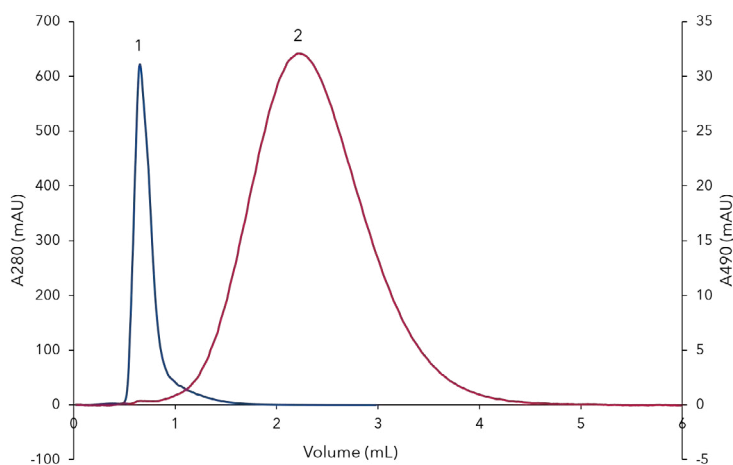
are thereby separated from the sample. This mechanism can be used as well for buffer exchange. dyes or for desalting and buffer exchange. Here, Fluorescein a popular fluorescent derivatization reagent used for labeling of biomolecules was removed after the labeling process by SEC. Another common use for SEC is desalting. Proteins of interest are not retained by the column and elute first. The small salt molecules elute later and are thereby separated from the sample. This mechanism can be used as well for buffer exchange.



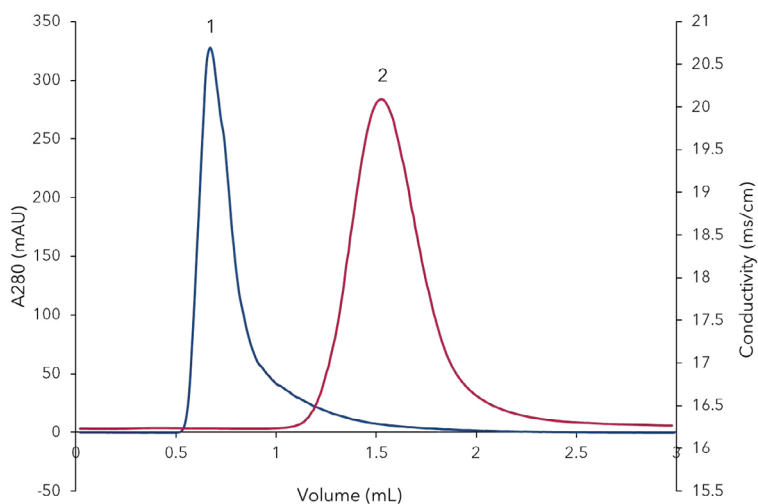
# Group separation with Sepapure Desalting on AZURA® Bio purification system

## RESULTS

In the first method bovine Serumalbumin (BSA) was separated from 5-Carboxyfluorescein (5-FAM) (**Fig 2**). The high molecular weight compound BSA (Peak 1) eluted before the low molecular weight molecule 5-FAM (Peak 2) from the Desalting column. In the second method (**Fig 3**) BSA (Peak 1) was separated from NaCl (Peak 2).



**Fig. 2** Separation of BSA and 5-FAM. Peak 1 BSA, Peak 2 5-FAM, red signal UV 280nm, blue signal UV460 nm



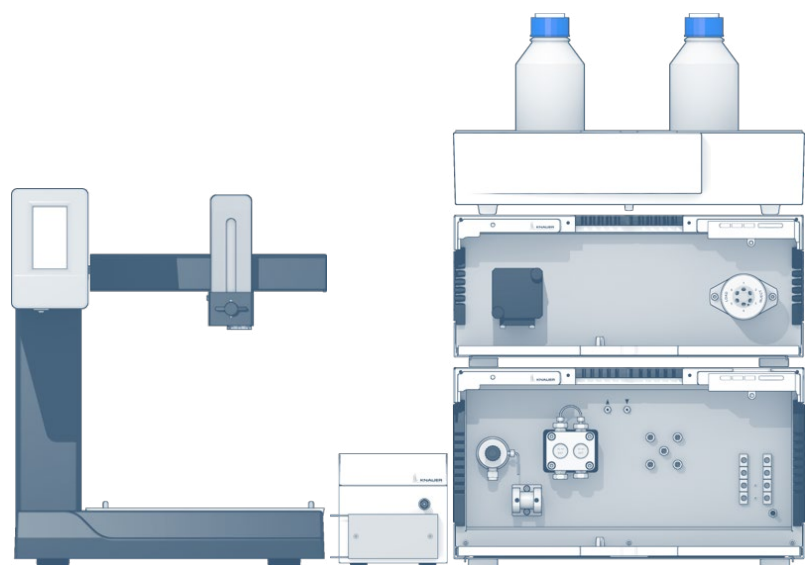
**Fig. 3** Desalting of BSA. Peak 1 BSA, Peak 2 NaCl, blue signal UV280 nm, red signal conductivity

## MATERIALS AND METHOD

In this application, an AZURA Bio purification system consisting of AZURA P 6.1L LPG metal-free pump with 10 mL pump head; AZURA ASM 2.1L assistant module with an injection valve and a single wavelength UV detector UVD 2.1S; AZURA CM 2.1S conductivity monitor and Foxy R1 fraction collector was used. 1 mg bovine serum albumin (BSA) and 3.75  $\mu\text{g}$  5-Carboxyfluorescein (5-FAM) was dissolved in PBS. Prior to the run the 1 mL Sepapure Desalting column was equilibrated with PBS. 50  $\mu\text{l}$  of the sample was injected with a flowrate of 1 mL/min. BSA was detected at 280 nm, 5-FAM was detected at 490nm and conductivity signal was recorded to monitor the salt peak.

## CONCLUSION

Sepapure Desalting can be used for the separation of small from large molecules. BSA was separated from a fluorescent dye. Additionally, the buffer was changed by a desalting step. These two examples illustrated the principle of group separation by SEC.



## ADDITIONAL MATERIALS AND METHODS

**Tab. A1** Method parameters

Buffer A	Washing buffer: PBS (phosphate buffered saline)		
Gradient	isocratic		
Flow rate	1 mL/min	System pressure	<3 bar
Column temperature	RT	Run time	6 min
Injection volume	Each 50 µL	Injection mode	-
Detection wavelength	280 nm 490 nm	Data rate	2 Hz

**Tab. A2** System configuration

Instrument	Description	Article No.
Pump	AZURA P6.1L LPG, 10 ml PEEK	<a href="#">APH69EB</a>
Assistant	AZURA ASM 2.1L Right: UVD2.1S Middle: - Left: V2.1S 6 Port/ 2Position	<a href="#">AYCALXEC</a>
Flow cell	3 mm semiprep, 2 µL biocompatible	<a href="#">A4045</a>
Conductivity monitor	CM 2.1S	<a href="#">ADG30</a>
Flow cell	Preparative up to 100 mL	<a href="#">A4157</a>
Column 2	Sepapure Desalting 5 mL	<a href="#">020X460SPZ</a>
Fraction collector	FoxyR1	<a href="#">A59100</a>
Software	PurityChrom, standard licence	<a href="#">A2650</a>

## RELATED KNAUER APPLICATIONS

[VBS0070](#) - Ion Exchange Chromatography with AZURA® Bio purification system

[VBS0071](#) - Comparison of two column sets for antibody purification in an automated two step purification process

[VBS0072](#) - Separation of proteins with cation exchange chromatography on Sepapure SP and CM

[VBS0073](#) - Separation of proteins with anion exchange chromatography on Sepapure Q and DEAE

[VBS0074](#) - Comparison of Ion Exchange columns

# DC with GC - Determination of catecholamines in plasma with electrochemical detection



Juliane Boettcher, Kate Monks; applications@knauer.net

KNAUER Wissenschaftliche Geräte GmbH, Hegauer Weg 38, 14163 Berlin; www.knauer.net

## SUMMARY

Epinephrine (adrenaline), norepinephrine (noradrenaline) and dopamine are termed as catecholamines. The determination of catecholamines is primarily used to help detect and rule out pheochromocytomas in symptomatic patients, i.e. in patients with persistent hypertension. It is also used in order to help monitor for recurrence when a pheochromocytoma has been detected and removed<sup>1</sup>. Applying HPLC coupled to electrochemical detection with direct current (DC) using a glassy carbon (GC) working electrode makes it possible to detect even lowest amounts of catecholamines in urine or plasma samples.

## INTRODUCTION

Catecholamines can act as neurotransmitters when they are produced in the sympathetic nervous system or the brain. When synthesized in the adrenal medulla, they act as circulating hormones. The endogenous catecholamines include dopamine, epinephrine, and norepinephrine. The specific compound formed depends on the enzymes produced by the synthesizing tissue. All three of these catecholamines are synthesized in a similar fashion, beginning with tyrosine<sup>2</sup>. They break down into vanillylmandelic acid, metanephrine, and normetanephrine. Metanephrine and normetanephrine also may be measured during

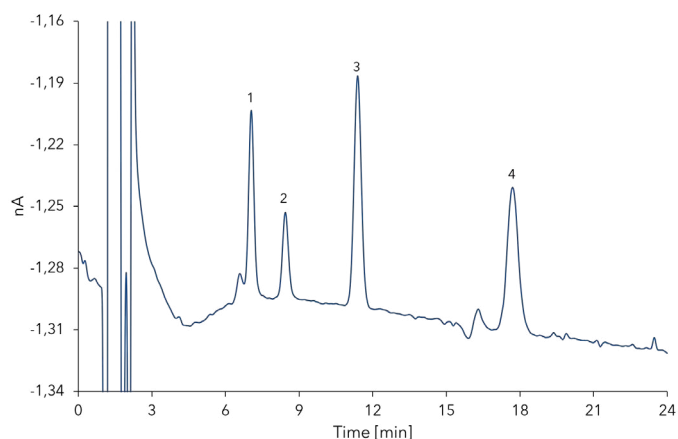
a catecholamine test. Catecholamines can increase heart rate, blood pressure, breathing rate, muscle strength, and mental alertness. They also reduce the amount of blood reaching the skin and intestines and increase the blood flow to the major organs such as brain, heart and kidneys. Certain rare tumors can increase the amount of catecholamines in the blood. This causes high blood pressure, excessive sweating, headaches, fast heartbeats (palpitations), and tremors<sup>3</sup>. The determination of catecholamines and metabolites is of great importance for the diagnosis and treatment of tumor diseases.



# DC with GC – Determination of catecholamines in plasma with electrochemical detection

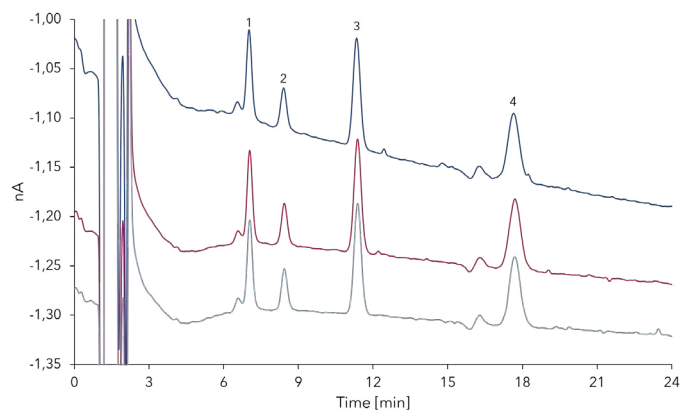
## RESULTS

Following the instructions of the ClinRep® complete kit for determination of catecholamines in plasma, first a standard solution of noradrenaline, adrenaline and dopamine was analyzed. This standard solution already contains the internal standard (IS). **Fig. 1** displays the chromatogram of the mixed catecholamines standard.



**Fig. 1** ClinRep® catecholamines standard: 1 - noradrenaline, 2 - adrenalin, 3 - IS, 4 - dopamine.

With the performance of multiple measurements the relative standard deviation (% RDS) of the method was determined. **Tab. 1** summarizes the calculated values of relative standard deviation for retention time and peak area ascertained with multiple measurements (n=3) of the catecholamine standard. **Fig. 2** shows an overlay of these measurements.

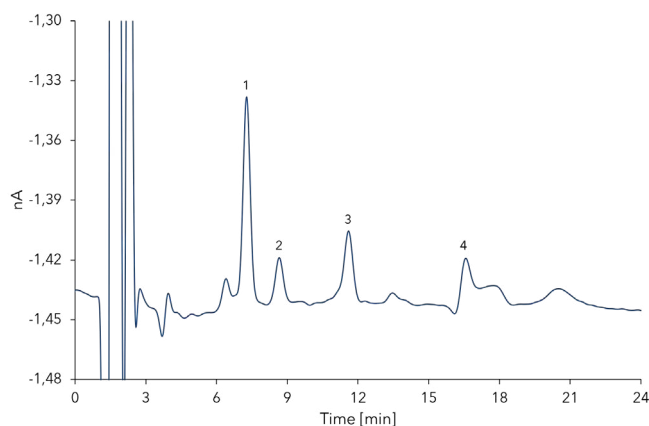


**Fig. 2** Overlay of multiple measurements of standard solution: 1 - noradrenaline, 2 - adrenalin, 3 - IS, 4 - dopamine.

**Tab. 1** Relative standard deviation of method (n=3)

Substance	Replicate	Retention time [min]	Area [nA.s]
Noradrenalin	1	7.025	1.262
	2	7.050	1.259
	3	7.050	1.252
%RSD		0.20	0.42
Adrenalin	1	8.417	0.719
	2	8.442	0.716
	3	8.442	0.714
%RSD		0.17	0.35
Dopamin	1	17.650	1.918
	2	17.700	1.973
	3	17.700	1.919
%RSD		0.16	1.62

The next step was to perform a single-point calibration with the corresponding plasma calibrator. Here the internal standard needs to be added and the calibrator was prepared according to the described sample preparation procedure. Finally, a ClinCheck® plasma control sample (Level II) was measured to verify the method and calibration (**Fig. 3**). Therefore, the sample with known amounts of catecholamines was set up, again following the described preparation procedure.



**Fig. 3** Chromatogram of plasma control sample: 1 - noradrenaline, 2 - adrenalin, 3 - IS, 4 - dopamine.

## RESULTS

The exact calculation of values considering the recovery is specified in the ClinRep® instructions. **Tab. 2** shows the comparison of the specified and measured

values of the plasma control sample. The measured results for the plasma control sample were within the required specifications.

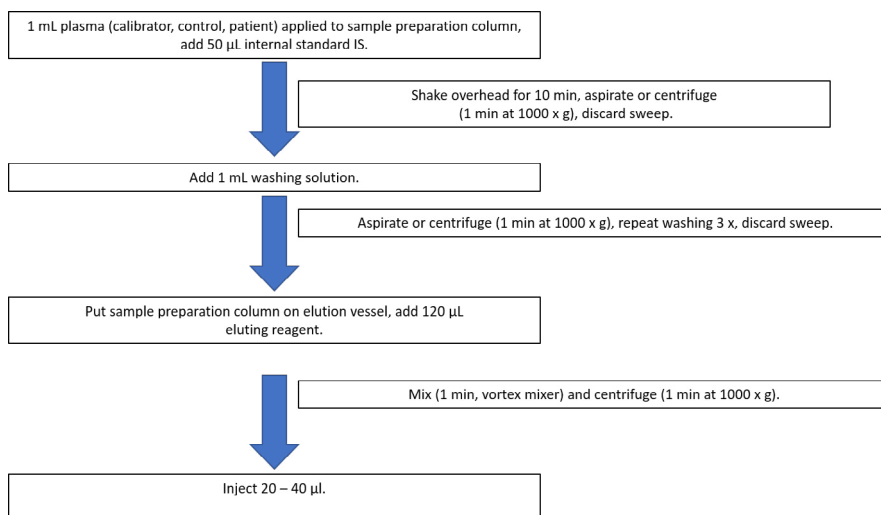
**Tab. 2** Comparison of specified and measured values of the plasma control sample

Substance	Specification [ng/L]		Value [ng/L]	% RSD
	min	max		
Plasma control sample				
Noradrenalin	1778	2667	2004 ± 29	1.45
Adrenalin	475	713	591 ± 3.5	0.59
Dopamin	423	704	537 ± 27	5.10

## SAMPLE PREPARATIONS

Sample preparation was performed according to the ClinRep® instructions included in the ClinRep® complete kit for the determination of catecholamines

in plasma. **Fig. 4** shows the schematic procedure of sample preparation<sup>1</sup>.



**Fig. 4** Schematic sample preparation procedure

## CONCLUSION

The ClinRep® HPLC complete kit for determination of catecholamines in plasma is easy to handle, due to the detailed instructions included. In combination with DC electrochemical detection, using the glassy carbon working electrode and the salt-bridge reference electrode, it is possible to quantify low amounts of catecholamines in urine or plasma samples.

## MATERIALS AND METHODS

**Tab. 3** Instrument setup

Column temperature	30 °C
Injection volume	20 µL
Injection mode	Partial loop
Detection	ECD (DC mode)

**Tab. 5** ECD settings (DC mode)

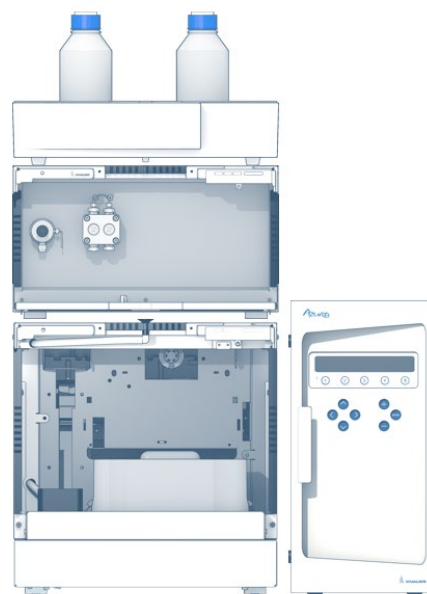
E cell	500 mV
Cell temperature	30 °C
Range	5 nA
Polarity	+
Compensation	On
AST position	2
Filter	0.02 Hz

**Tab. 6** System configuration

Instrument	Description	Article No.
Pump	AZURA P 6.1L, isocratic	<a href="#">APH30EA</a>
Autosampler	AZURA AS 6.1L	<a href="#">AAA01AA</a>
Detector	AZURA ECD 2.1	<a href="#">A1651</a>
Flow cell	SenCell GC Salt-Bridge high sensitivity electrochemical flow cell	<a href="#">A1652</a>
Column	Eurospheer II 100-5 C8, 150 x 4 mm ID with precolumn	<a href="#">15WE081E2J</a>
Software	ClarityChrom 8.1 - Workstation, autosampler control included	<a href="#">A1670</a>
Software	ClarityChrom 8.1 - System suitability extension (SST)	<a href="#">A1677</a>

**Tab. 4** Pump parameters

Eluent (A)	ClinRep® mobile phase for catecholamines in plasma
Flow rate	1 mL/min
Gradient	isocratic



## REFERENCES

- [3] Recipe, Catecholamines. <https://recipe.de/products/catecholamines-plasma> (February 2, 2020).
- [4] Simmons, J.P. Wohl, J.S. Vasoactive catecholamines. In: Silverstein, D., Hopper, K. Small animal critical care medicine. Elsevier (2009).
- [5] University of Michigan, Catecholamines in blood. <https://www.uofmhealth.org/health-library/tw12861> (February 2, 2020).

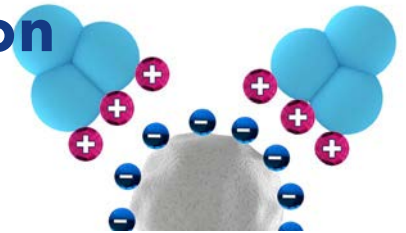
## RELATED KNAUER APPLICATIONS

[VPH0017J](#) - Determination of Catecholamines II

[VPH0009J](#) - HPLC method for the determination of Amineptine and its main Metabolite in human plasma



# Automated two step purification with cation exchange chromatography and desalting



Ulrike Krop, Kate Monks; [applications@knauer.net](mailto:applications@knauer.net)

KNAUER Wissenschaftliche Geräte GmbH, Hegauer Weg 38, 14163 Berlin; [www.knauer.net](http://www.knauer.net).

## SUMMARY

In many cases protein purification requires two or even more steps to achieve sufficient purity. The transition from one step to another can be very time consuming and requests manual interaction. These limitations illustrate the need for FPLC systems enabling automated two step purification. This application highlights the possibility of combining two subsequent chromatography protocols. This was achieved using the KNAUER Lab standard Multi Method FPLC system adapted for automatic two step purification. An exemplary separation of model proteins by cation exchange chromatography followed by desalting is shown. This approach can easily be adapted to various protein purification protocols.

## INTRODUCTION

For many protein purifications several chromatographic steps are used to achieve pure protein. Depending on the desired yield and purity of the target protein different methods are combined. In many cases two steps for protein purification are used. For the two step purification two independent methods, each with their associated specific column, are used to realize the purification of the target molecule without manual interference. The general principle is that the protein sample is applied on the first column. During elution of the protein, the protein peak is detected triggering its collection in a storage loop or storage vessel. Subsequently, the target protein is automatically applied on the second column to further enhance the

quality and/or purity. The fast and automated connection of two chromatographic purification steps into one method eliminates manual sample handling and minimizes time spent between steps. This automation strategy can be easily adapted to several purification tasks increasing your efficiency and optimizing the workflow. In this application note a KNAUER Lab standard Multi Method FPLC system for all bio chromatography methods was adapted for two step purification. Two model proteins cytochrome C and ribonuclease A were separated by cation exchange chromatography. Cytochrome C was automatically stored in a sample loop and applied onto a second column for buffer exchange with a desalting column.



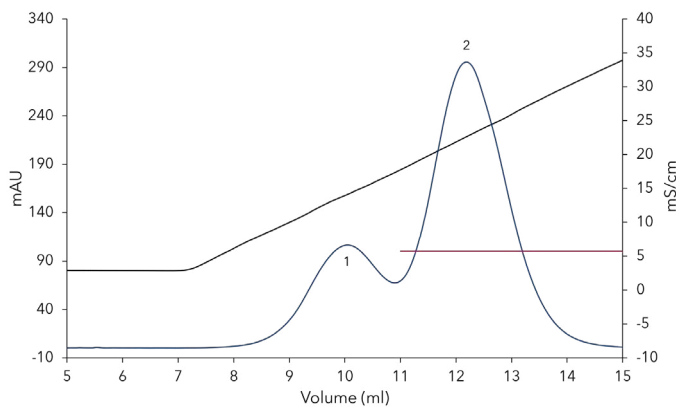
Additional Information

# Automated two step purification with cation exchange chromatography and desalting

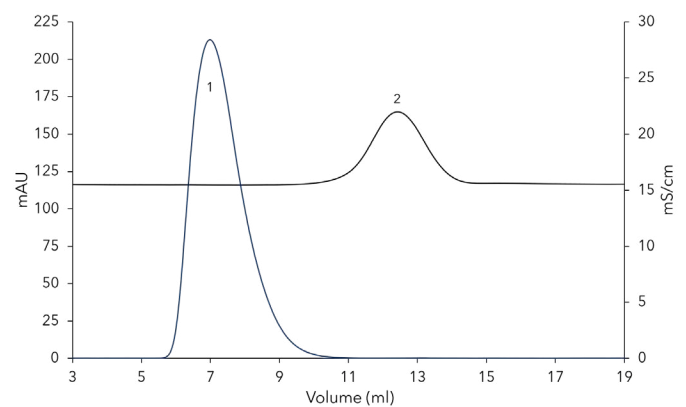
## RESULTS

The first step of the separation was cation exchange chromatography. The proteins were chosen due to their positive charge in buffer at pH 6.8. Ribonuclease A has an isoelectric point of 9.6, while for cytochrome C a range from 10.37 to 10.80 for the isoelectric point is reported. With the starting conditions both proteins were binding to the cation exchange column. During gradient elution first ribonuclease A and later

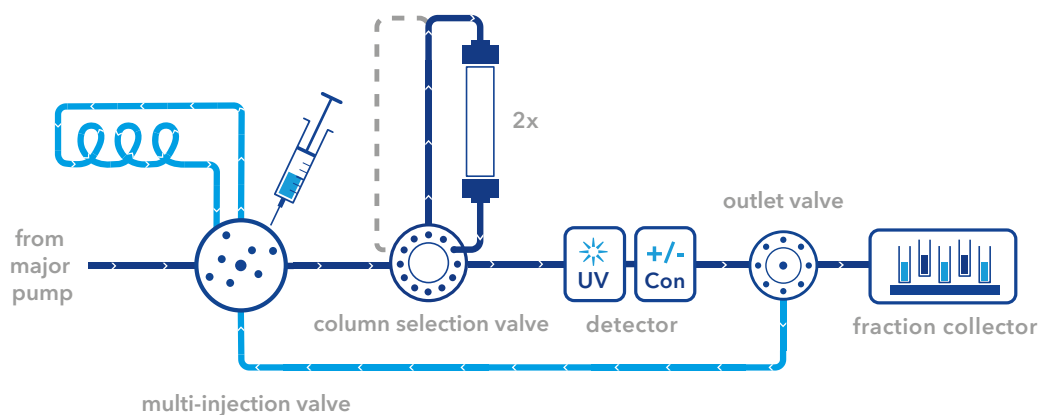
cytochrome C eluted from the column (Fig. 1). A threshold signal (Fig. 1, red line) was used to detect cytochrome C triggering the intermediate storage in the sample loop. The cytochrome C was subsequently reinjected on the desalting column to exchange the buffer to the final buffer conditions (Fig. 2). The eluted protein was fractionated.



**Fig. 1** Chromatogram of the cation exchange method. Blue line: UV 280 nm (blue), conductivity (black), threshold used for peak recognition (red). 1 - Ribonuclease A, 2 - Cytochrome C.



**Fig. 2** Chromatogram of the desalting method. UV 280 nm (blue), conductivity (black). 1 - Cytochrome C, 2 - Salt peak.



**Fig. 3** Flow scheme of the lab standard KNAUER Multi Method FPLC system for all bio chromatography methods adapted for two step purification with the basic set up.

## SAMPLE PREPARATIONS

Lyophilized cytochrome C from bovine heart (CAS# 9007-43-6) and lyophilized ribonuclease A from bovine pancreas (9001-99-4) was used. Both proteins were dissolved in buffer A to a final concentration of 0.5 mg/ml. In total, 2 ml of sample (1 mg of each protein) was injected for each purification. The sample was filtered before use (0.45 µm). A Lab standard KNAUER Multi Method FPLC system for all bio chromatography methods was adapted for two step purification.

A column selection valve and an outlet valve were added to the system. This shows the basic set up for two step purification. The reinjection position of the outlet valve was connected to the sample pump inlet of the injection valve. The sample is injected via the sample loop of the injection valve. The first peak is collected in the sample loop of the injection valve as well and reinjected onto the second column.

## CONCLUSION

The model protein cytochrome C was successfully purified from ribonuclease A by an automated combination of a cation exchange chromatography and a desalting method on the Lab standard KNAUER Multi Method FPLC system in the basic set up for two step

purification. No manual interaction was necessary. This method setup could easily be adapted to other purification protocols for the separation and purification of biomolecules highlighting.

## RELATED KNAUER APPLICATIONS

[VBS0070](#) - Ion exchange chromatography with AZURA® Bio purification system

[VBS0072](#) - Separation of proteins with cation exchange chromatography on Sepapure SP and CM

[VBS0075](#) - Group separation with Sepapure Desalting on AZURA® Bio purification system

## MATERIALS AND METHODS

**Tab. 1** Method

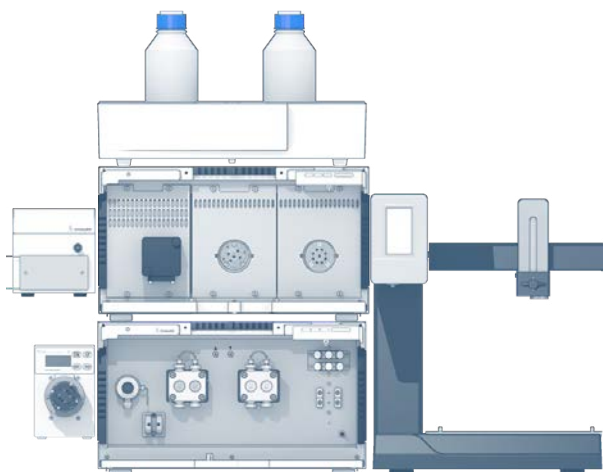
Column temperature	RT
Sample loop volume	2 ml
UV Detection	280 nm
Data rate	2 Hz
Buffer A	25 mM sodium phosphate buffer pH 6.8
Buffer B	25 mM sodium phosphate buffer pH 6.8 + 1M NaCl
Buffer C	PBS 0.01 M phosphate buffered saline (NaCl 0.138 M; KCl - 0.0027 M); pH 7.4

**Tab. 2** Cation exchange method

Column	Sepapure CM FF6 1 ml
Flow rate	1 ml/min
Gradient	5 ml step 100% A 10 ml gradient 100% A to 60% A / 40% B
Peak recognition	10-15 ml Threshold: UV 280 nm 100 mAU

**Tab. 3** Desalting

Column	Sepapure desalting 5 ml
Flow rate	2.5 ml/min
Gradient	1.5 CV isocratic buffer C



**Tab. 4** Wash and equilibration of cation exchange method

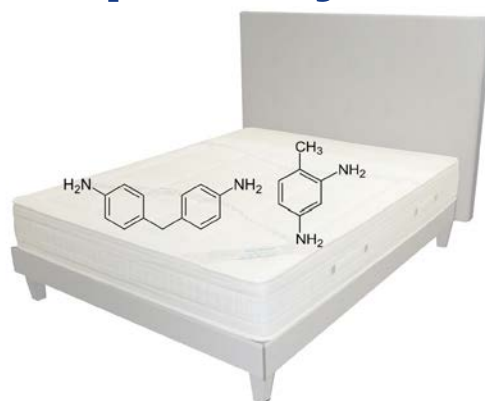
Column	Sepapure CM FF6 1 ml
Flow rate	1 ml/min
Gradient	5 ml step 100% B 10 ml step 100% A

**Tab. 5** System configuration

Instrument	Description	Article No.
Pump	AZURA P6.1L, LPG Metal-free, low pressure gradient FPLC pump with 10 ml pump head, ceramic	<a href="#">APH64EB</a>
Docking station	AZURA Assistant ASM 2.2L	<a href="#">AY0001</a>
UV detector	Left module: UV detector UVD 2.1S	<a href="#">EDA03XA</a>
Valve drive	Middle module: Valve drive VU 4.1	<a href="#">EWA04</a>
Valve drive	Right module: Valve drive VU 4.1	<a href="#">EWA04</a>
UV flow cell	Semi-preparative biocompatible 3 mm UV flow cell	<a href="#">A4045</a>
Injection valve	AZURA V 4.1 Valve Multi-injection valve, biocompatible, 1/16"	<a href="#">AVN94CE</a>
Outlet valve	AZURA V 4.1 Valve Biocompatible multiposition valve, 8 Port	<a href="#">AVS34CE</a>
Column selection valve	VICI column selection valve Biocompatible column selection valve, for 5 columns, 1 bypass, reverse flow, 12 ports, 1/16", 50 bar	<a href="#">AVZ52CE</a>
Valve drive	AZURA Valve unifier VU 4.1 Smart valve drive with RFID technology for valves V 4.1	<a href="#">AWA01XA</a>
Conductivity monitor	AZURA CM 2.1S with flow cell up to 100 ml/min Conductivity monitor with flow cell for up to 100 ml/min and optional pH measurement	<a href="#">ADG30GD</a>
Fraction collector	Fraction collector Foxy R1	<a href="#">A59100</a>
Software	PurityChrom® Basic	<a href="#">A2650</a>
Column 1	Sepapure CM FF6 1 ml, weak cation exchange, prepacked 1 ml, 100 µm, 3 bar	<a href="#">010X15QSPZ</a>
Column 2	Sepapure desalting 5 ml, prepacked 5 ml, 20 - 50 µm, 3 bar	<a href="#">020X460SPZ</a>

# Quantitative determination of primary aromatic amines in recycled cold-cure and flexible foams

Juliane Böttcher, Kate Monks; applications@knauer.net  
KNAUER Wissenschaftliche Geräte GmbH, Hegauer Weg 38, 14163 Berlin;  
www.knauer.net



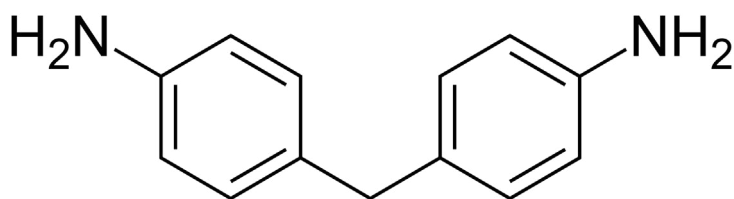
## SUMMARY

A reliable method for the quantification of aryl amines in cold-cure and flexible foams from recycled mattresses is described in the following application. The focus was set on two substances, 2,4-diaminotoluene (TDA) and 4,4-diaminodiphenylmethane (DAPM), which are mandatory to be determined before processing the recycled foam due to their carcinogenic properties.

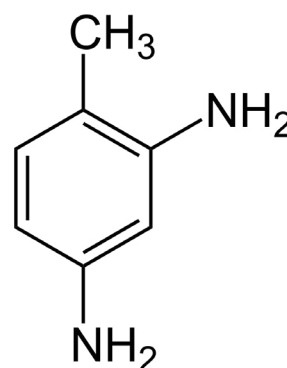
## INTRODUCTION

Cold-cure and flexible foams used for the production of mattresses are made of polyurethane synthetics. During the synthesis of urethanes, which are the basis for polyurethanes, different intermediate products are formed. Two of these products occurring in the process are DAPM and TDA. Both substances are classified as carcinogenic. Furthermore TDA is presumed

to be teratogenic and mutagenic. When recycling the cold-cured and flexible foams it is necessary to determine the concentration of these compounds before reusing the foams. Referring to OEKO-TEX® Standard 100 a limit value of 20 mg/kg for aryl amines is appointed [1].



2,4-Diaminotoluene



4,4-Diaminodiphenylmethane



# Quantitative determination of primary aromatic amines in recycled cold-cure and flexible foams

## RESULTS

For the quantification a calibration was made. Therefore a mixed standard of DAPM and TDA at five different concentrations was used. For both components a correlation coefficient of  $R^2=0.999$  was achieved. Exemplary one sample of flexible foam was selected and spiked with standard to a concentration of

0.1 mg/mL. **Fig 1** shows the sample measurement and **Fig 2** shows an overlay of the sample (red) and spiked sample (blue) of flexible foam. The limit of detection (LOD) was determined with 0.63  $\mu\text{g/mL}$  for TDA and 0.67  $\mu\text{g/mL}$  for DAPM.

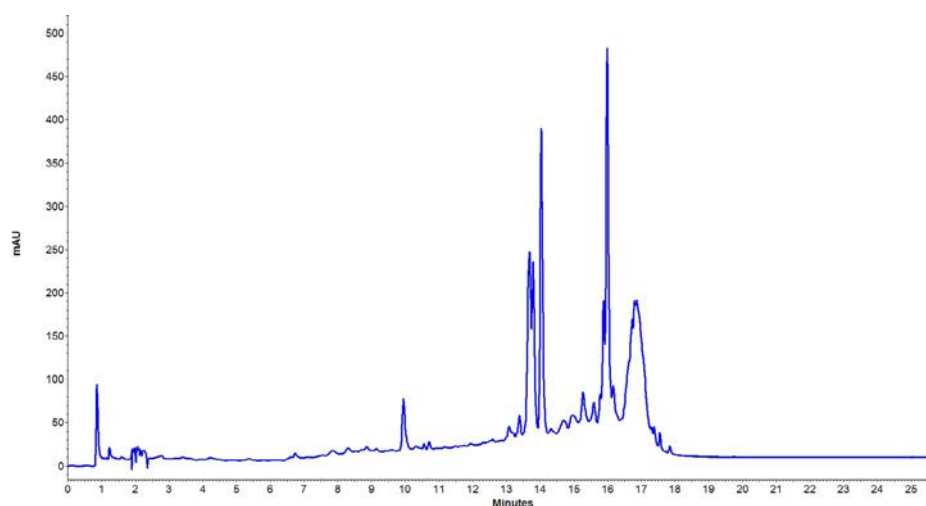


Fig. 1 Sample of flexible foam (18 mg/mL)

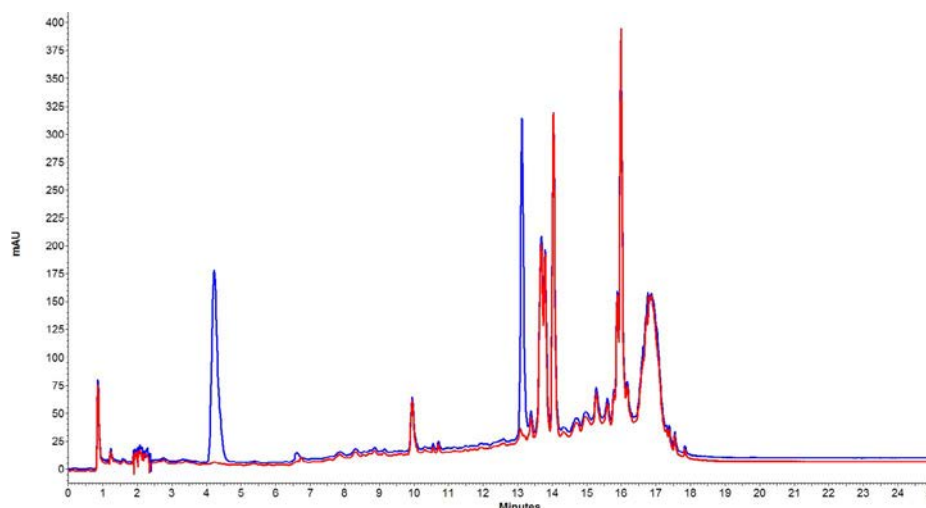


Fig. 2 Overlay of sample (red) and spiked sample (blue) of flexible foam

## MATERIALS AND METHODS

An AZURA® Analytical HPLC Plus system for a pressure range up to 700 bar was used for this application. It consisted of an AZURA P 6.1L LPG pump, an autosampler 3950, an AZURA CT 2.1 column thermostat and an AZURA MWD 2.1L multiwavelength detector. The analytical method was run with a step gradient at a flow rate of 1.0 mL/min. The mobile phase was a mixture of water and acetonitrile, both with 0.1 % triethylamine as mobile phase modifier. The column thermostat was set to 25 °C and the detector recorded at 290 nm. The column that was used was filled with ProntoSIL 120-3 C8 ace EPS silica.

## CONCLUSION

With the developed method and the AZURA HPLC Plus system it was possible to perform a rapid quantitative analysis of 2,4-diaminotoluene and 4,4-diaminodiphenylmethane without time consuming sample preparation. Even a complex matrix such as the recycled cold-cured and flexible foams can be determined robust and reproducible with the specified method parameters.

## REFERENCES

[6] [https://www.oeko-tex.com/de/business/certifications\\_and\\_services/ots\\_100/ots\\_100\\_limit\\_values/ots\\_100\\_limit\\_values.html](https://www.oeko-tex.com/de/business/certifications_and_services/ots_100/ots_100_limit_values/ots_100_limit_values.html)



## ADDITIONAL RESULTS

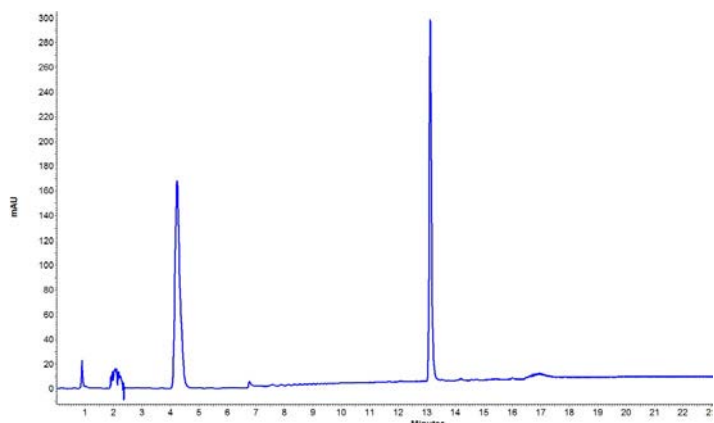


Fig.A1 Mixed standard of TDA and DAPM (both 0.1mg/mL)

## ADDITIONAL MATERIALS AND METHODS

Tab.A1 Method parameters

Eluent A	H <sub>2</sub> O <sub>dd</sub> +0.1 % TEA		
Eluent B	Acetonitrile+0.1 % TEA		
Gradient	Time [min]	% A	% B
	0	95	5
	5	95	5
	15	35	65
	15.02	0	100
	25	0	100
	25.02	95	5
35	95	5	
Flow rate	1 mL/min	System pressure	ca. 190 bar
Column temperature	25 °C	Run time	35 min
Injection volume	10 µL	Injection mode	Full loop
Detection wavelength	290 nm	Data rate	20 Hz
		Time constant	0.05 sec

Tab.A2 System configuration & data

Instrument	Description	Article No.
Pump	AZURA® P 6.1L LPG, 10 ml, SSt	<a href="#">APH35EA</a>
Autosampler	Autosampler 3950	<a href="#">A50070</a>
UV Detector	AZURA® MWD 2.1L	<a href="#">ADB01</a>
Flow cell	LightGuide 10 mm, 2 µL	<a href="#">AMC19</a>
Thermostat	AZURA® CT 2.1	<a href="#">A05852</a>
Eluent tray	AZURA® E 2.1L	<a href="#">AZC00</a>
Column	Vertex Plus Column 150 x 4.6 mm ProntoSIL 120-3 C8 ace EPS with precolumn	<a href="#">15VF08APSG</a>
Software	OpenLAB CDS EZChrom Edition	<a href="#">A2600-1</a>

## RELATED KNAUER APPLICATIONS

[VCH0016](#) - Determination and quantification of acrylic acid derivatives



# Determination and quantification of acrylic acid derivatives

Juliane Böttcher, Kate Monks; [applications@knauer.net](mailto:applications@knauer.net)  
KNAUER Wissenschaftliche Geräte GmbH, Hegauer Weg 38, 14163 Berlin; [www.knauer.net](http://www.knauer.net)



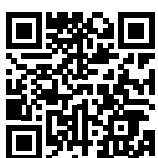
## SUMMARY

We are constantly exposed to acrylic monomers as part of our everyday lives. Diverse forms can be found at home, at work, on the street, or at the supermarket. End products based on acrylic monomers are utilized in many products from paints and lacquers to adhesives, water treatment products, and plastics to detergents, or textile fibers. In this application, four common acrylic acid derivatives were quantified with the AZURA® HPLC Plus system.

## INTRODUCTION

Acrylate monomers used to form acrylate polymers are based on the structure of acrylic acid or are derivatives of it. Acrylic acid and some acrylate oligomers and monomers can affect human health as eye and skin irritants. Residual monomers might be exposed to consumers and that is why the content of residual

monomers in acrylic polymers needs to be examined. Methyl methacrylate, 2-hydroxyethyl methacrylate, ethylhexyl acrylate, and isobornyl acrylate are examples of acrylic acid derivatives and were determined in this application.

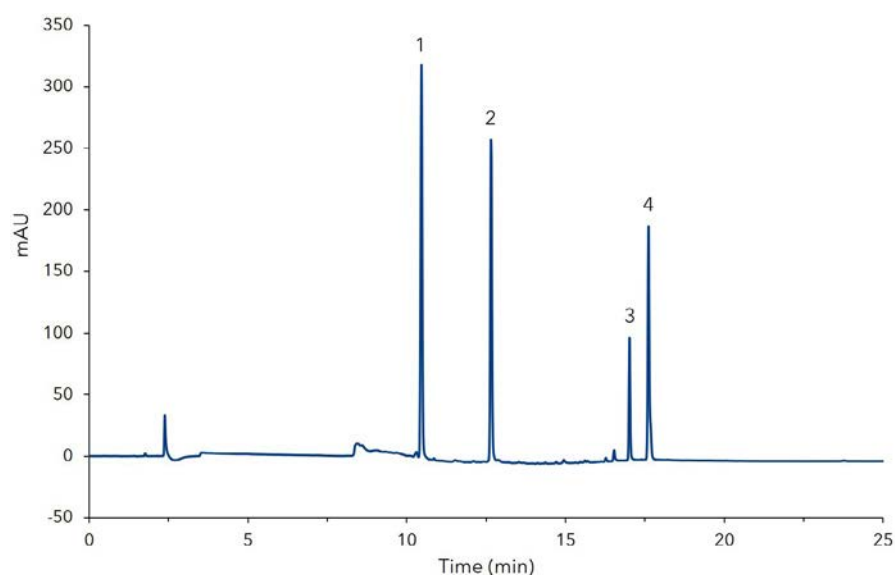


# Determination and quantification of acrylic acid derivatives

## RESULTS

A mixed standard of the four acrylate monomers was used to determine a calibration with the following concentrations for each compound: 0.001 mg/mL, 0.002 mg/mL, 0.004 mg/mL, 0.01 mg/mL, and 0.02 mg/mL. The four detected peaks are baseline separated. **Fig 1** shows the chromatogram of the acrylate mix standard

at a concentration of 0.01 mg/mL. For all compounds the limit of detection (LOD, S/N=3) and the limit of quantification (LOQ, S/N=10) were calculated based on the measurement of the lowest calibration concentration. **Tab 1** displays a summary of the determined quantification results.



**Fig. 1** Measurement of standard mix (0.01 mg/mL); 1) 2-Hydroxyethyl methacrylate, 2) Methyl methacrylate, 3) Ethylhexyl acrylate, 4) Isobornyl acrylate

**Tab. 1** LOD and LOQ of acrylic monomers

Substance	LOD (µg/mL)	LOQ (µg/mL)
2-Hydroxyethyl methacrylate	0.022	0.07
Methyl methacrylate	0.032	0.11
Ethylhexyl acrylate	0.075	0.25
Isobornyl acrylate	0.042	0.14

## MATERIALS AND METHODS

All standards were provided by the Fraunhofer-Institut für Fertigungstechnik und Angewandte Materialforschung IFAM [2]. For this application an AZURA analytical system was used which consisted of an AZURA P 6.1L quaternary LPG pump, an AZURA DAD 6.1L diode array detector, an AZURA CT 2.1 column thermostat and an AZURA AS 6.1L autosampler. The flow was set to 1 mL/min at a column temperature of 40 °C. The detection wavelength was set to 210 nm. The sampling rate was set to 1 Hz and the time constant to 0.2 s. 10 µl of the standards were injected. The column with the dimensions 150 x 4.6 mm ID with pre-column was filled with Eurospher II 100-3 C18 silica.

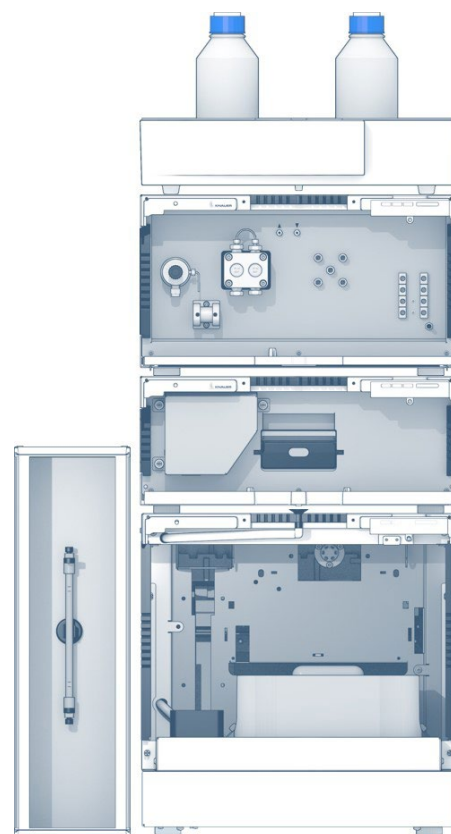
## CONCLUSION

The developed gradient consisted of two different elution steps. The first gradient step from water to acetonitrile separates the acrylic monomers. In the second step from acetonitrile to tetrahydrofuran, polyacrylates potentially present in the polyacrylate matrix can be eluted/washed from the column. These two steps are useful when both polar and non-polar acrylates are to be separated. Furthermore, this simplifies the sample preparation which in the end leads to a reduced analysis time.

## REFERENCES

[1] [http://www.acrylicmonomers.basf.com/portal/8/en/dt.jsp?page=basf\\_acrylic\\_monomers](http://www.acrylicmonomers.basf.com/portal/8/en/dt.jsp?page=basf_acrylic_monomers)

[2] Fraunhofer-Institut für Fertigungstechnik und Angewandte Materialforschung IFAM



## ADDITIONAL MATERIALS AND METHODS

**Tab. A1** Method parameters

Eluent A	Water + 0.1% phosphoric acid			
Eluent B	Acetonitrile			
Eluent C	Tetrahydrofuran			
Gradient	Time (min)	% A	% B	% C
	0	100	0	0
	5	100	0	0
	15	0	100	0
	25	0	100	0
	28	0	0	100
	38	0	0	100
	41	0	100	0
	51	0	100	0
	51.1	100	0	0
	60	100	0	0
Flow rate	1 mL/min	Run time	60 min	
Column temperature	40 °C	Injection mode	Partial loop	
Injection volume	10 µL	Data rate	1 Hz	
Detection wavelength	210 nm	Time constant	0.2 s	

**Tab. A2** System configuration & data

Instrument	Description	Article No.
Pump	AZURA® P6.1L, LPG 10 mL	<a href="#">APH34EA</a>
Autosampler	AZURA® AS 6.1L	<a href="#">AAA00AA</a>
Detector	AZURA® DAD 2.1L	<a href="#">ADC01</a>
Flow cell	PressureProof Cartridge 10mm, 10µL	<a href="#">AMC38</a>
Column	Eurospher II 100-3 C18, Vertex Plus Column 150 x 4.6 mm ID with precolumn	<a href="#">15VE181E2G</a>
Thermostat	AZURA® CT 2.1	<a href="#">A05852</a>
Software	ClarityChrom 7.2	<a href="#">A1670-11</a>

## RELATED KNAUER APPLICATIONS

[VCH0015](#) - Quantitative determination of primary aromatic amines in recycled cold-cure and flexible foams

# Molecular weight distribution of a broad polystyrene standard



Juliane Böttcher, Lisa Loxterkamp, Jan Wendrich, Kate Monks; applications@knauer.net  
KNAUER Wissenschaftliche Geräte GmbH, Hegauer Weg 38, 14163 Berlin; www.knauer.net

## SUMMARY

Gel permeation chromatography (GPC) and size exclusion chromatography (SEC) describe the separation of molecules based only on their molecular size. Using an AZURA® GPC it is possible to run GPC/SEC applications with aqueous as well as organic solvents, when changing the system modules with the suitable compatibility.

## INTRODUCTION

GPC and SEC are based on the same separation principle, size exclusion. GPC can characterize polymers with determining the molecular weight distribution and the refractive index. In former times the term SEC was used for aqueous applications with stationary phases, e.g. dextran. GPC on the other side was applied with organic solvents and for instance polystyrene stationary phases. Nowadays both definitions are used side by side for the same separation. The peculiarity of GPC and SEC is that analysis is performed over one column volume, which results in a negative partition coefficient ( $k$ ) for the analytes. The complete separation is therefore taking place over the selective permeation range which depends on the pore and exclusion volume<sup>1</sup>. The analyte needs to be dissolved in the eluent during

separation to determine the exact molecular weight distribution. Sorption or chemical interactions with the stationary phase or wetted parts are objectionable. GPC is a relative molecular weight determination, where the best alternative is using the direct standard calibration in which case the standard is the same polymer type as the sample<sup>2</sup>. This application gives an example of the mentioned appliance. A calibration with narrow polystyrene standards on a polystyrene stationary phase was performed. With this calibration a broad polystyrene standard was analyzed. The obtained results are compared to the given values of the certificate of the broad standard to illustrate that KNAUER AZURA devices are suitable for GPC/SEC implementation.

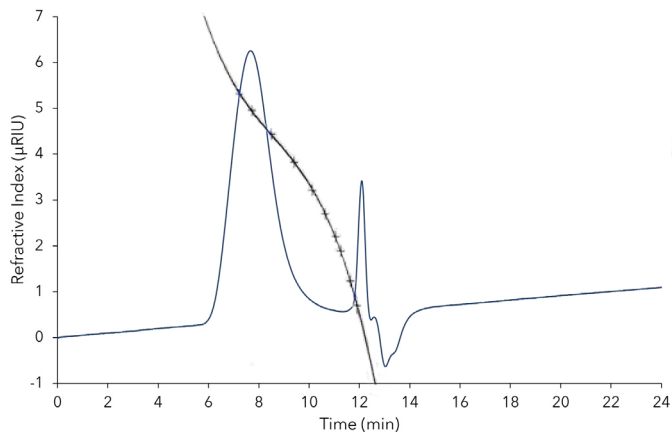


# Molecular weight distribution of a broad polystyrene standard

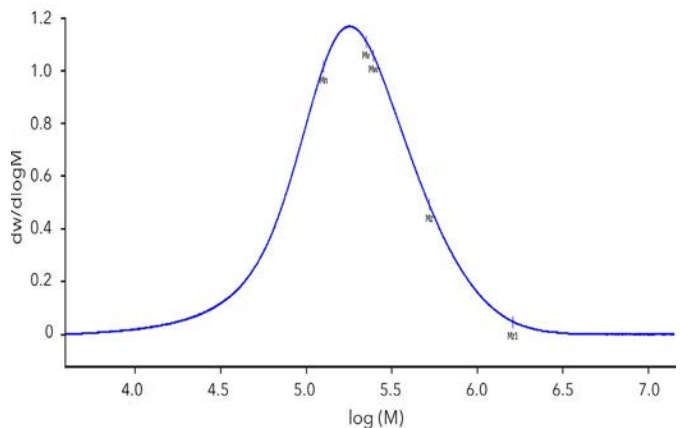
## RESULTS

The elugram in **Fig. 1** shows an overlay of the RID trace of the broad standard and the determined calibration curve. Here it can be seen that the elution volume or the peak maximum of the broad standard lies within the calibration range. By using the ClarityChrom GPC/SEC extension it is easy to obtain the desired information about the molecular weight distribution of the analyzed samples. **Fig. 2** exemplarily shows the distribution of the broad standard. The certificate of the broad standard provides the following values:  $M_w=248000$  Da and  $M_n=143000$  Da. The polydispersity is given with a value of  $PD=1.73$  [ $M_w/M_n$ ]. In comparison the calculated result with ClarityChrom are  $M_w=247163$  Da,

$M_n=126765$  Da and  $PD=1.95$  [ $M_w/M_n$ ]. The deviation of the calculated values compared to the certificate might be a result of the used column with mixed porosities resulting in a broader weight distribution. This column normally is used for screening purposes and did not provide the best resolution. In addition, the broad standard signal is not completely within the calibration range, which makes the deviation of  $M_n$  and  $PD$  plausible. Another effect could be the approximated  $K$  and  $\alpha$  coefficients which are not exactly according the measurement conditions due to the different temperature. For exact coefficient determination a viscosity detector should be used.



**Fig. 1** Polystyrene broad standard elugram (blue) with the calibration curve (black) in the background .

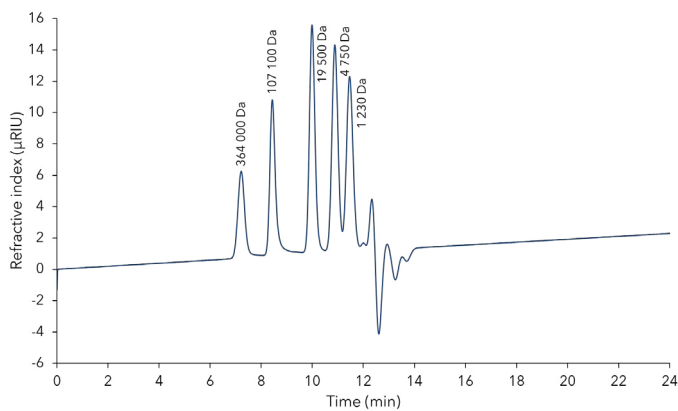


**Fig. 2** Molecular weight distribution of the polystyrene broad standard.

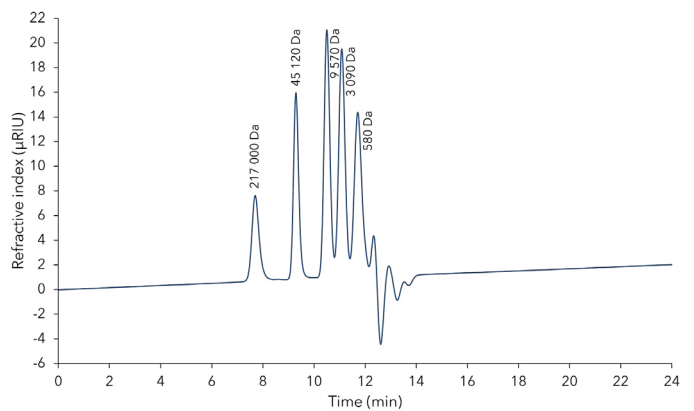
## SAMPLE PREPARATIONS

A calibration in a range from 580 Da to 364 kDa using the EasiCal PS-2 calibration kit was prepared. Standards were prepared directly in the vial and dissolved in approximately 1.5 ml THF. 30 mg of the broad standard polystyrene were weighed in a volumetric flask

and dissolved in 10 ml THF overnight. The used K and  $\alpha$  Houwink coefficient were provided by the Clarity-Chrom software with  $K=14.1$  [dl/g\*10<sup>5</sup>] and  $\alpha=0.7$  at 25 °C. The elugrams of the measured calibration standards are shown in **Fig. 3** and **Fig. 4**.



**Fig. 3** Polystyrene Standard PS-2 A.



**Fig. 4** Polystyrene Standard PS-2 B.

## CONCLUSION

As pumps are available for normal phase operation, aqueous/organic and aqueous mode KNAUER devices are perfectly suitable for this application.

## MATERIALS AND METHODS

**Tab. 1** Method parameters

Column temperature	23 °C
Injection volume	20 µl
Injection mode	Partial loop
Detection	RI
Data rate, Time constant	20 Hz, 0.05 s
Temperatur of RID	35 °C

**Tab. 3** System configuration

Instrument	Description	Article No.
Pump	AZURA P6.1L HPG	<a href="#">APH35ED</a>
Degasser	2 channel GPC degasser	<a href="#">A5335</a>
Autosampler	AZURA AS 6.1L	<a href="#">AAA00AA</a>
Detector	AZURA RID 2.1L	<a href="#">ADD31</a>
Thermostat	AZURA CT 2.1	<a href="#">ATC00</a>
Column	AppliChrom® ABOA StyDiViBe-P-10E5A-BPT, 5 µm, GPC column 300 x 8 mm	<a href="#">30GW470ABJ</a>
Software	ClarityChrom 8.2.2	<a href="#">A1670</a>
Software	ClarityChrom GPC Extension	<a href="#">A1678</a>

**Tab. 2** Pump parameters

Eluent	Tetrahydrofuran stabilized with BHT
Compressibility	0.97
Flow rate	1 ml/min
Pressure	~ 35 bar
Pump program	isocratic

**Tab. 4** Standards and samples

Name	Molecular weight data
Polystyrene Standard EasiCal PS-2, Agilent	
Standard A	364 000, 107 100, 19 500, 4 750, 1 230 Da
Standard B	217 000, 45 120, 9 570, 3 090, 580 Da
Polystyrene PSS-psb250k Lot: psbr240k	Mw: 248 000 Da Mn: 143 000 Da PDI: 1.73

## REFERENCES

- [7] Wu, C. Handbook of size exclusion chromatography. Marcel Dekker (1995).  
[8] Teraoka, I. Polymer Solutions: An introduction to physical properties. John Wiley & Sons, Inc. (2002).

## RELATED KNAUER APPLICATIONS

[VFD0153](#) - GPC cleanup of olive oil samples

[VFD0166](#) - LC-FLD of 4 PAHs in olive oil samples using AZURA® GPC Cleanup System

[VFD0172](#) - A D E K - Easy separation of fat-soluble vitamins using GPC/SEC



# Mirror, mirror... - Chiral column screening for enantioseparation of $\alpha$ -ionone

Juliane Boettcher<sup>1</sup>, Martin Steinhaus<sup>2</sup>, Jörg Stein<sup>2</sup>, Kate Monks<sup>1</sup>; applications@knauer.net  
<sup>1</sup>KNAUER Wissenschaftliche Geräte GmbH, Hegauer Weg 38, 14163 Berlin; www.knauer.net  
<sup>2</sup>Leibniz-Institut für Lebensmittel-Systembiologie an der Technischen Universität München



## SUMMARY

The chiral separation of enantiomers is interesting for different fields of applications, e.g. pharmaceutical products, perfumery, and flavouring. Sometimes both enantiomers can be used for the application, sometimes only one enantiomer is of further interest. Ionones are closely related substances to the group of rose ketones which are key aroma chemicals in the successful recreation of rose scents.

## INTRODUCTION

Chirality is one of the basic principles in nature. It denominates the fact, that there are items which act like image and mirror image but can't be brought to congruence along an axis of reflection although they are similar. Human hands are the most common used example of chirality. The left hand is a non-superimposable mirror image of the right hand. In chemistry, chirality describes the steric configuration of atoms in molecules which have the same constitution. Most often the cause of chirality in molecules is the presence of an asymmetric carbon atom. The Cahn-Ingold-Prelog-convention (short: CIP-convention or (R,S)-system) helps to give a distinct description of the spatial arrangement of the different bound substituents and to classify the enantiomers.

The following column screening was performed to separate the enantiomers of  $\alpha$ -ionone. The (R)-enantiomer has a violet, raspberry and floral smell, whereas the (S)- $\alpha$ -ionone has a violet like and woody smell.

The use of  $\alpha$ -ionone is very multifarious. Because of its valuable violet aroma, it is used for fragrances as well as consumables like chewing gum, beverages, pastries, and sweets. [1],[2]

Three different chiral stationary phases (CSPs) were used. The Eurospher II Chiral AM/AM R is a coated phase with amylose-tris-3,5-dimethylphenyl-carbamate as chiral selector whereas the Eurospher II Chiral OM/OM-R is a cellulose tris-3,5-dimethylphenylcarbamate coated porous silica phase. The AM phase is suitable for normal phase and the AM-R can be used with reversed phase solvents (same for OM and OM-R). The third CSP used for screening, Eurospher II Chiral NR, is an immobilized brush-type phase with very broad generality and complementary selectivity to Eurospher II Chiral AM and OM. It is very stable because the Chiral-NR selector is covalently bound, so that all HPLC eluents can be used.



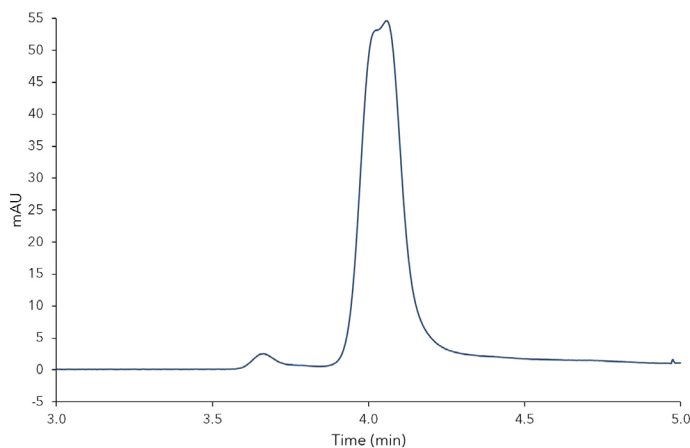
# Mirror, mirror... - Chiral column screening for enantioseparation of $\alpha$ -ionone

## RESULTS

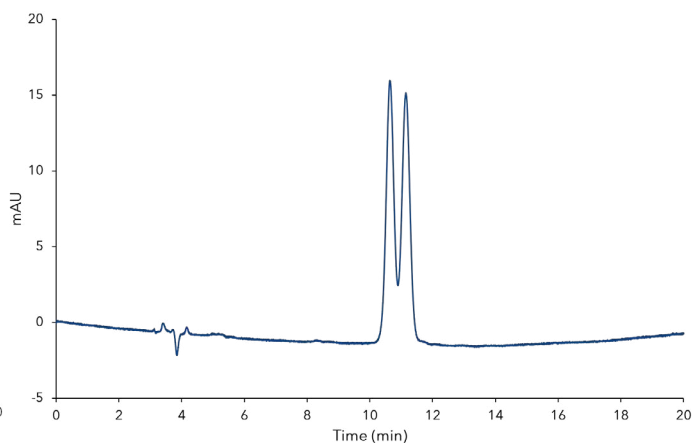
The screening was performed under reversed phase and normal phase conditions. The samples were provided by the Leibniz-Institute for Food Systems Biology at the Technical University of Munich. A concentration of approximately 2 mg/mL of a racemic  $\alpha$ -ionone standard was dissolved in n-hexane and in methanol. Before injection the samples were diluted in a ratio of 1:20 with methanol for reversed phase measurements and n-heptane for normal phase.

During the normal phase screening two different eluent compositions were used: n-heptane:ethanol 95:5 (v/v) and n-heptane:isopropanol 95:5 (v/v). The reversed phase measurement was also performed with two different eluents: acetonitrile and methanol. The detailed method parameters are shown in

the additional materials and methods section. Under reversed phase conditions no separation was achieved for the AM-R and OM-R stationary phases. **Fig. 1** shows the chromatogram of the ionone standard on the AM-R phase with methanol as eluent, where only a minimal separation is seen. Therefore, the focus was set to normal phase. Again, no enantioseparation of  $\alpha$ -ionone was accomplished using OM and AM CSPs, but the Eurospher II Chiral NR was successful. **Fig. 2** shows the measurement of  $\alpha$ -ionone on the NR phase with n-heptane:isopropanol 95:5 (v/v) as eluent. A classification of the peaks to (R)- or (S)- $\alpha$ -ionone was not possible because no enantiopure standard was available. **Tab. 1** summarizes the calculated values for capacity, resolution and selectivity.



**Fig. 1** Chromatogram of the  $\alpha$ -ionone on the AM-R phase with methanol (zoom)



**Fig. 2** Chromatogram of  $\alpha$ -ionone on the NR phase with n-heptane:isopropanol 95:5 (v/v)

**Tab. 1** Calculated values and retention times

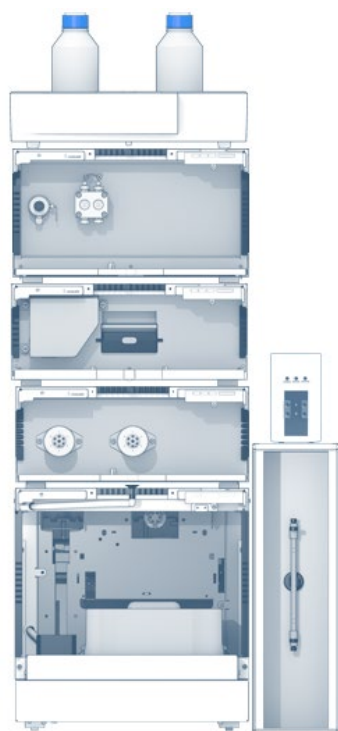
Parameter	Value
unretained peak time	t0 3.849 min
retention time 1	t1 10.638 min
retention time 2	t2 11.147 min
capacity factor 1	k1 1.7638
capacity factor 2	k2 1.8961
selectivity	$\alpha$ 1.0750
resolution	R 1.0680

## MATERIALS AND METHODS

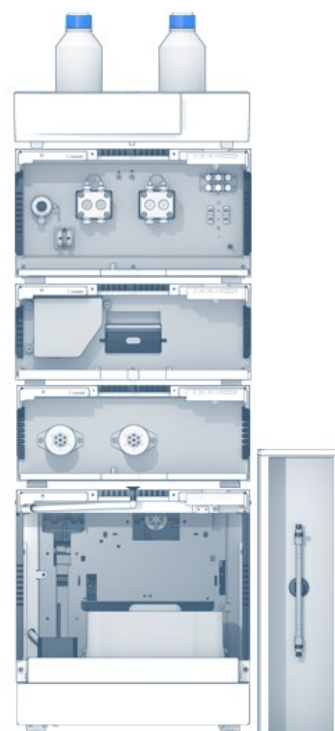
Two configurations of AZURA analytical systems were used. The normal phase screening was performed with an isocratic AZURA P 6.1L for normal phase applications in combination with the GPC degasser. In reversed phase mode an AZURA P 6.1L HPG pump was used. All other devices were the same for both systems: AZURA CT 2.1 thermostat, autosampler AZURA AS 6.1L, AZURA DAD 2.1L. All measurements ran isocratic at flow rate of 0.7 mL/min. The detection wavelength was set to 220 nm and 3D data were acquired. An additional assistant AZURA ASM 2.1L was used for column switching in the reversed phase screening system. All data were recorded using the ClarityChrom 8.1 software.

## CONCLUSION

The screening process contained the verification of three stationary phases: Chiral-NR, Chiral-AM/AM-R and Chiral-OM/OM-R. The aim of the screening was to find an appropriate CSP for the separation. A successful chiral separation of (R)- and (S)- $\alpha$ -ionone was realised using the Eurospher II Chiral NR phase under normal phase conditions. A further method optimization could possibly improve the resolution. The application of n-heptane without the addition of alcohols would be reasonable but will lead to longer retention times. Another alternative would be the screening of further, more special, chiral stationary phases.



AZURA HPLC Plus system configuration for normal phase



AZURA HPLC Plus system configuration for reversed phase

## REFERENCES

[9] <http://www.thegoodscentscompany.com/data/rw1011952.html>, 07.08.2019

[10] <https://www.internetchemie.info/chemie-lexikon/stoffe/a/alpha-isomethyl%20ionone.php>, 07.08.2019

## ADDITIONAL MATERIALS AND METHODS

**Tab. A1** Method parameters

Column temperature	25 °C
Injection volume	1 µL
Injection mode	Partial Loop
Detection	UV 220 nm
Data rate	10 Hz

**Tab. A2** Pump parameters (normal phase)

Eluent 1	n-heptane:isopropanol 95:5 (v/v)
Eluent 2	n-heptane:ethanol 95:5 (v/v)
Gradient	isocratic
Flow rate	0.7 mL/min

**Tab. A3** Pump parameters (reversed phase)

Eluent 1	methanol
Eluent 2	acetonitrile
Gradient	isocratic
Flow rate	0.7 mL/min

**Tab. A4** System configuration

Instrument	Description	Article no.
Pump	AZURA P6.1L, isocratic NP	<a href="#">APH30ED</a>
Pump	AZURA P6.1L HPG, RP	<a href="#">APH35EA</a>
Degasser	2 channel GPC degasser	<a href="#">A5335</a>
Autosampler	AZURA AS 6.1L	<a href="#">AAA00AA</a>
Detector	AZURA DAD 2.1L	<a href="#">ADC01</a>
Thermostat	AZURA CT 2.1	<a href="#">A05852</a>
Assistant (optional)	ASM 2.1L, Left: 6Mpos, 1/16", sst, 300 bar middle: 6Mpos, 1/16", sst, 300 bar right: empty module	<a href="#">AYEHEHLX</a>
Column 1	Eurospher II Chiral AM, 250 x 4 mm ID with precolumn	<a href="#">25WM320E2J</a>
Column 2	Eurospher II Chiral AM-R, 250 x 4 mm ID with precolumn	<a href="#">25WM32RE2J</a>
Column 3	Eurospher II Chiral OM, 250 x 4 mm ID with precolumn	<a href="#">25WM370E2J</a>
Column 4	Eurospher II Chiral OM-R, 250 x 4 mm ID with precolumn	<a href="#">25WM37RE2J</a>
Column 5	Eurospher II Chiral NR, 250 x 4 mm ID with precolumn	<a href="#">25WE110E2J</a>
Software	ClarityChrom 8.1 - workstation, autosampler control included	<a href="#">A1670</a>
Software	ClarityChrom 8.1 - PDA extension	<a href="#">A1676</a>

## RELATED KNAUER APPLICATIONS

[VCR0058J](#) - Chiral separation of p-Menthadienol ((1R/S,4R)-1-methyl-4-(prop-1-en-2-yl)cyclohex-2-enol)

[VCR0029J](#) - Chiral separation of Flavanone (2-Phenyl-1,4-Benzopyrone)

# Systematic HPLC method development and robustness evaluation of 13 carbonyl DNPH derivatives using DryLab®

Lilit Avagyan, Kate Monks; applications@knauer.net  
KNAUER Wissenschaftliche Geräte GmbH, Hegauer Weg 38, 14163 Berlin; www.knauer.net



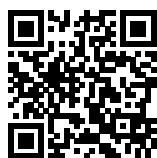
## SUMMARY

In the monitoring of industrial air, the determination of carbonyl (aldehyde and ketone) emissions is crucial to prevent respiratory, pulmonological, autoimmune diseases, and cancer. According to the analytical method described in the DIN ISO 16000-3 [1], the carbonyls must be converted to their corresponding hydrazones with 2,4-dinitrophenylhydrazin (DNPH) in order to be detected via UV detector and analyzed by reversed phase HPLC. Here, the DryLab® software was used for method optimization to separate of 13 carbonyl derivatives in a standard mixture with the AZURA® HPLC system and the DNPH-column.

## INTRODUCTION

The main objective of method optimization in HPLC is to define the appropriate conditions for robust, precise, and reproducible analysis. In order to save resources, a computer assisted method development can be a valuable tool. For the characterization of carbonyl content in air samples, commonly a standard mixture of 13 aldehyde and ketone DNPH derivatives is used. For precise analysis a good separation of all 13 components has to be achieved. Here, the

chromatography modelling software DryLab® with 3D Cube option was used for the optimization of the analysis of the carbonyl standard mixture. The investigation of the combined influence of gradient time, temperature and ternary eluent composition on critical resolution enabled the development of robust method conditions. Furthermore, the robustness space was investigated *in silico* and verified experimentally with a high degree of agreement.



# Systematic HPLC method development and robustness evaluation of 13 carbonyl DNPH derivatives using DryLab®

## RESULTS

The separation of 13 carbonyls was analyzed according to the method described in DIN ISO 16000-3 [1]. The obtained chromatogram from this experiment resulted 11 peaks (Fig. 1). The peaks representing acetone-DNPH, Acroleine-DNPH, 2-Butanone-DNPH, Methacroleine-DNPH, and butyraldehyde-DNPH were not separated. In order to optimize method parameters in silico, DryLab requires measurements under 12 conditions (Fig. 2). The measurements were conducted as described below. The obtained chromatograms were fed into the DryLab software resulting in the Method Operation Design Region (MODR). The red regions in the cube represent the optimal

chromatographic conditions (Fig. 3). The selection of the best parameters from the predicted data pull are based on high resolution values. The optimal separation method was established with the solvent composition water and acetonitrile, with a column temperature at 22 °C and a gradient time of 14 min. As the results show (Fig. 4) the baseline separation of acetone-DNPH and acroleine-DNPH was reached with the resolution value of 2.69 (see suppl. results Tab. A1). The lowest resolutions were obtained between peak pairs 2-Butanone-DNPH, Methacroleine-DNPH (1.27) and Methacroleine-DNPH, n-Butylaldehyde (1.29).

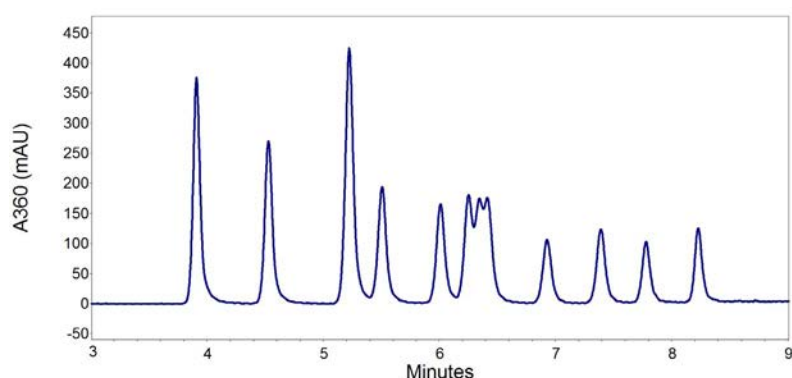


Fig. 1 Chromatogram of 13 carbonyls, measured according to ISO DIN 16000-3 method with the DNPH column with the DNPH column

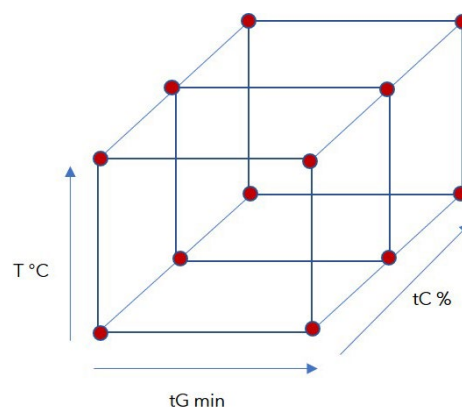


Fig. 2 DryLab 3D Cube with 12 red pointed measurement conditions

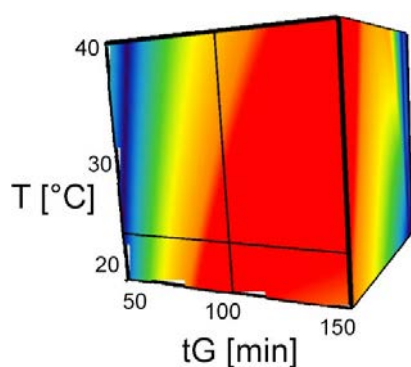


Fig. 3 MODR Method Operation Design Region

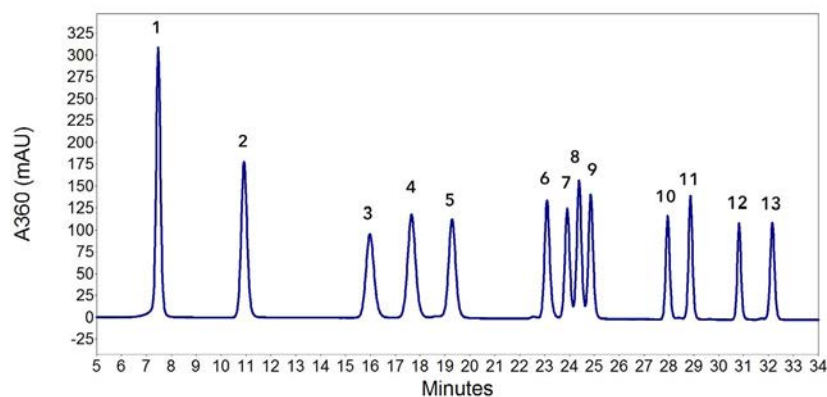


Fig. 4 Chromatogram of 13 carbonyls, measured according to DryLab® predicted method with the DNPH column

## MATERIALS AND METHODS

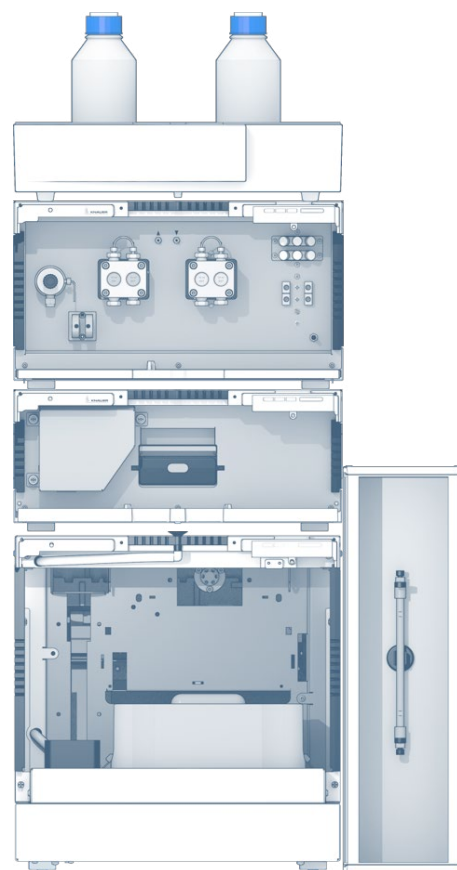
The HPLC system includes the pump AZURA® P 6.1L HPG, detector AZURA® DAD 6.1L, autosampler AZURA® AS 6.1L, column thermostat AZURA® CT 2.1. The method separation, described in DIN ISO 16000-3 [1] and following method optimization was performed on DNPH-column (150 x 3 mm). The standard with 13 aldehyde and ketone derivatives, dissolved in acetonitrile was obtained from SigmaAldrich and was diluted to a concentration of 1 µg/mL in acetonitrile. For method optimization, the DryLab® (Version 4) modeling software (Molnár-Institute, Berlin) was used. The optimal separation conditions were predicted based on 12 chromatograms. The measurements were performed by three different mobile phase compositions (100% MeOH, 50:50 MeOH:Acetonitrile, 100% Acetonitrile). Each composition was used for measurements at two different temperatures and gradient times, namely 20 and 40 °C, and 30 and 90 min respectively. The analysis of chromatograms was performed by the using of OpenLab chromatographic software. For the method optimization the column parameters, initial gradient conditions and dwell volume of the system were programmed in the DryLab® software. The chromatographic data files were converted in to AIA (\*.CDF) format and loaded in the DryLab® for the calculation.

## REFERENCES

[1] DIN ISO 16000-3; Indoor air - Part 3: Determination of formaldehyde and other carbonyl compounds in indoor air and test chamber air - Active sampling method (ISO 16000-3:2011)

## CONCLUSION

The DryLab® software is an important part in the HPLC method optimization. Our results show, that it makes possible to define optimal separation conditions without performing of numerous unnecessary measurements. This software helps to save the time, to reduce the consumption of materials and perform ecological 'green' HPLC.



## ADDITIONAL RESULTS

Tab. A1 Content of the standard solution under optimized chromatographic conditions (Fig 4)

#	Component name	Retention time	Resolution	RSD %	#	Component name	Retention time	Resolution	RSD %
1	Formaldehyde-DNPH	7.47	-	0.63	8	Methacroleine-DNPH	24.38	1.27	0.15
2	Acetaldehyde-DNPH	10.92	8.78	0.65	9	n-Bytaldehyde-DNPH	24.84	1.29	0.19
3	Acetone-DNPH	15.96	9.33	0.79	10	Benzaldehyde-DNPH	27.94	9.30	0.12
4	Acroleine-DNPH	17.63	2.69	0.47	11	Valeraldehyde-DNPH	28.85	3.00	0.38
5	Propionaldehyde-DNPH	19.26	2.81	0.53	12	m-Tolualdehyde-DNPH	30.81	6.66	0.10
6	Crotonaldehyde-DNPH	23.08	8.17	0.17	13	m-Tolualdehyde-DNPH	32.14	4.35	0.18
7	2-Butanone-DNPH	23.09	2.08	0.14					

## ADDITIONAL MATERIALS AND METHODS

Tab. A2 Method parameters

Eluent A	H <sub>2</sub> O <sub>dd</sub>		
Eluent B	Acetonitrile		
Gradient	Time [min]	% A	% B
	0	60	40
	16	60	40
	30	40	60
	40	40	60
	41	60	40
Flow rate	1 mL/min	System pressure	-
	22 °C	Run time	45 min
Column temperature			
Injection volume	10 µL	Injection mode	-
	360 nm	Data rate	20 Hz
Detection wavelength		Time constant	0.05 s

Tab. A3 System configuration

Instrument	Description	Article No.
Pump	AZURA P 6.1L	<a href="#">APH35GA</a>
Autosampler	AZURA AS 6.1L	<a href="#">AAA10AA</a>
Detector	AZURA DAD 6.1L	<a href="#">ADC11</a>
Flow cell	High Sensitivity LightGuide	<a href="#">AMD59XA</a>
Thermostat	AZURA CT 2.1	<a href="#">A05852</a>
Column	DNPH-Column, II 100-3	<a href="#">15CE490E2G</a>
Software	OpenLAB CDS EZChrom Edition	<a href="#">A2619-1</a>



# Determination of aromatic hydrocarbon types according to DIN EN 12916:2016



Juliane Böttcher, Kate Monks; [applications@knauer.net](mailto:applications@knauer.net)

KNAUER Wissenschaftliche Geräte GmbH, Hegauer Weg 38, 14163 Berlin; [www.knauer.net](http://www.knauer.net)

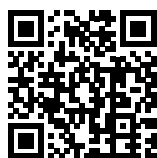
## SUMMARY

In this work aromatic hydrocarbons were determined under normal phase conditions using an AZURA<sup>®</sup> analytical HPLC plus system with RI detection according to the DIN EN 12916:2016. The instrumental setup and method can be used to determine the content of hydrocarbons in motor diesel fuels, which is important for protecting the environment and public health. The standards used for system suitability according to DIN EN 12916:2016 are also part of the calibration used in the IP391(2000)/ASTM D6591 methods but the method settings are slightly divergent.

## INTRODUCTION

The content of hydrocarbons in motor diesel fuels affects exhaust emissions and fuel combustion characteristics. These emissions are measured by the cetane number which is an indicator of the combustion speed of diesel fuel and compression needed for ignition [1]. It is important to measure these values due to an incomplete burning, for protecting the environment and public health. The DIN EN 12916:2016 is suitable for the determination of monoaromatic (MAH), diaromatic (DAH) and tri+ - aromatic (T+AH) hydrocarbons

in diesel fuels containing up to 30% (v/v) fatty acid methyl esters (FAME) and petroleum distillates with a boiling range of 150 °C up to 400 °C. The amount of polycyclic aromatic (Poly-AH) hydrocarbons will be calculated as the sum of diaromatic and tri+ - aromatic hydrocarbons. [2] Working according to this regulatory also requires a system suitability test to make sure that chosen HPLC hardware as well as the selected column are suitable for the application.

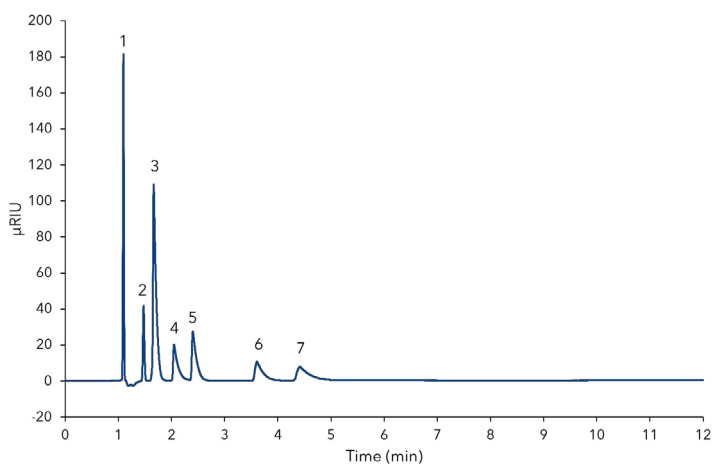


# Determination of aromatic hydrocarbon types according to DIN EN 12916:2016

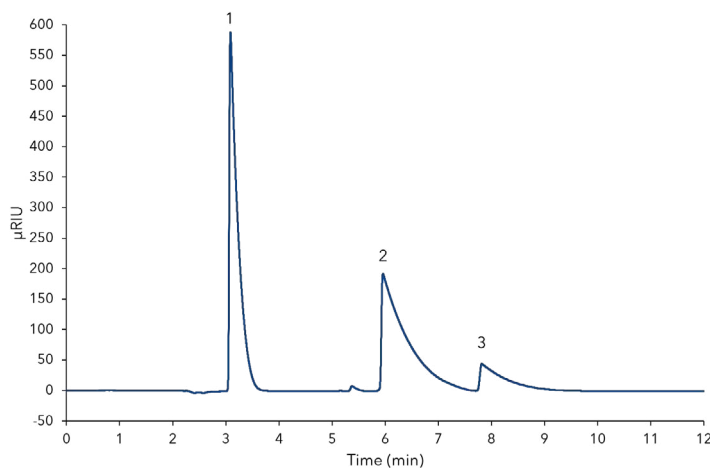
## RESULTS

The detailed requirements and calculations for performing the system suitability are described in DIN EN 12916:2016. After achieving all necessary system specifications, a calibration was made. **Fig 1** exemplary shows the separation of system calibration standard 1 (SCS 1) containing cyclohexane, 1-phenyldodecane, o-xylene, hexamethyl benzene, naphthalene, dibenzothiophene and 9-methylanthracene. The calibration

standard consists of three different compounds: 1,2-dimethyl benzene, fluorene and phenanthrene. **Tab 1** shows the concentrations for each compound at four different levels. **Fig 2** shows the chromatogram of calibration standard A. The calculation of the number of hydrocarbons in real samples corresponds to retention times of MAH, DAH and T+AH determined in the calibration.



**Fig. 1** System calibration standard 1 (SCS 1), 1) cyclohexane, 2) 1-phenyldodecane, 3) 1,2-dimethyl benzene, 4) hexamethyl benzene, 5) naphthalene, 6) dibenzothiophene, 7) 9-methylanthracene



**Fig. 2** Calibration standard level A, 1) 1,2-dimethyl benzene, 2) fluorene, 3) phenanthrene

**Tab. 1** Calibration concentrations at four different levels

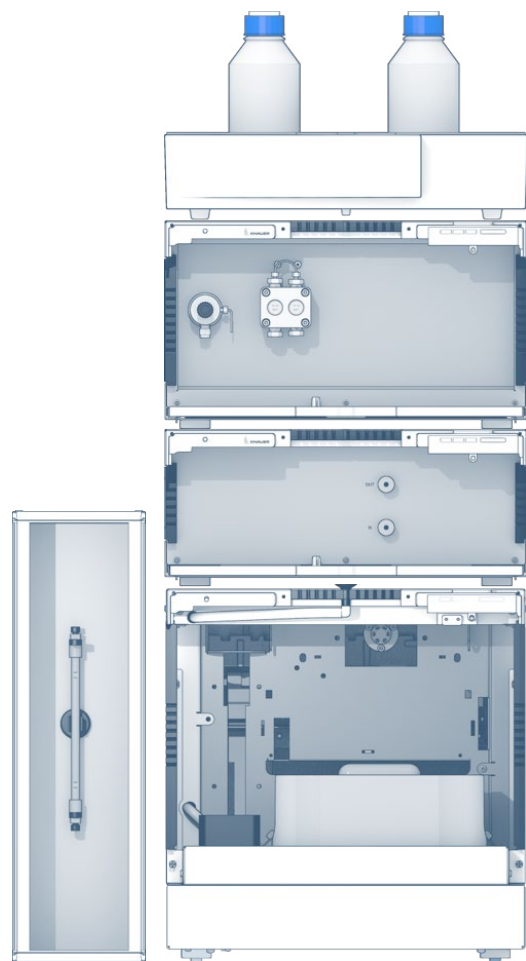
Calibration standard	1,2-Dimethylbenzene (g/100 mL)	Fluorene (g/100 mL)	Phenanthrene (g/100 mL)
A	4.00	2.00	0.40
B	2.00	1.00	0.20
C	0.25	0.25	0.05
D	0.05	0.05	0.01

## MATERIALS AND METHODS

An analytical AZURA HPLC system was used for this application. It consisted of an isocratic AZURA P 6.1L pump, suitable for normal phase application. Furthermore, an AZURA RID 2.1L detector, an AZURA AS 6.1L autosampler and an AZURA CT 2.1 column thermostat. The eluent was n-heptane at a flow rate of 1.2 mL/min. The column temperature was set to 25 °C. Detector settings were set to 20 Hz with a time constant of 0.05 s. The column in a dimension 250 x 4 mm ID was filled with Nucleodur 100-5 NH<sub>2</sub> silica.

## CONCLUSION

Using this instrumental setup, it is possible to determine mono and di-aromatic hydrocarbons according to the DIN EN 12916:2016.



## REFERENCES

[1] <http://www.astm.org/Standards/D6591.htm>

[2] DIN EN 12916:2016 Petroleum products - Determination of aromatic hydrocarbon types in middle distillates - High performance liquid chromatography method with refractive index detection, German version

## ADDITIONAL MATERIALS AND METHODS

**Tab. A1** Method parameters

Eluent A	n-heptane		
Gradient	isocratic		
Flow rate	1.2 mL/min		
Run temperature	25°C	Run time	30 min
Injection volume	10 µL	Injection mode	Full loop
Detection wavelength	RI	Data rate	20 Hz
		Time constant	0.05 s

**Tab. A2** System configuration & data

Instrument	Description	Article No.
Pump	AZURA P6.1L, isocratic, normal phase	<a href="#">APH30ED</a>
Autosampler	AZURA AS 6.1L	<a href="#">AAA00AA</a>
Detector	AZURA RID 2.1L	<a href="#">ADD31</a>
Column thermostat	AZURA CT 2.1	<a href="#">A05852</a>
Column	Nucleodur 100-5 NH2 for normal phase, 250 x4 mm ID	<a href="#">25DE190NDJ</a>
Software	ClarityChrom 7.4.2 - Workstation, autosampler control included	<a href="#">A1670</a>

## RELATED KNAUER APPLICATIONS

[VEV0080](#) - Determination of mono- and polyaromatic hydrocarbons in petrol with AZURA® Analytical HPLC system using RI detection

# Determination of mono- and polyaromatic hydrocarbons in diesel fuels with HPLC using RI detection



Lilit Avagyan<sup>1</sup>, Stephanie Hutfless<sup>2</sup>, Kate Monks<sup>1</sup>; applications@knauer.net

<sup>1</sup>KNAUER Wissenschaftliche Geräte GmbH, Hegauer Weg 38, 14163 Berlin; www.knauer.net

<sup>2</sup>Haltermann Carless Deutschland GmbH, Hamburg, Germany

## SUMMARY

The content of aromatic hydrocarbons in diesel fuel has an influence on exhaust emission and its combustion characteristics. Here we present the determination of aromatic hydrocarbons under normal phase conditions with an isocratic AZURA<sup>®</sup> Analytical HPLC system and detection via refractive index detector AZURA RID 2.1L.

## INTRODUCTION

It is well known that the best performance and maximum lifetime of an engine can be reached, when the amount of aromatic hydrocarbons in diesel and aviation turbine fuels is as low as possible. Since the aromatic hydrocarbon content can affect the cetane number of fuels and cause emissions due to incomplete

burning, there are different regulations to protect the environment and public health. Below, we describe a method according to DIN EN 12916 [1] for the determination of mono- and polyaromatic hydrocarbons, like 1,2-dimethylbenzene, fluorene, and phenanthrene in diesel fuel samples.

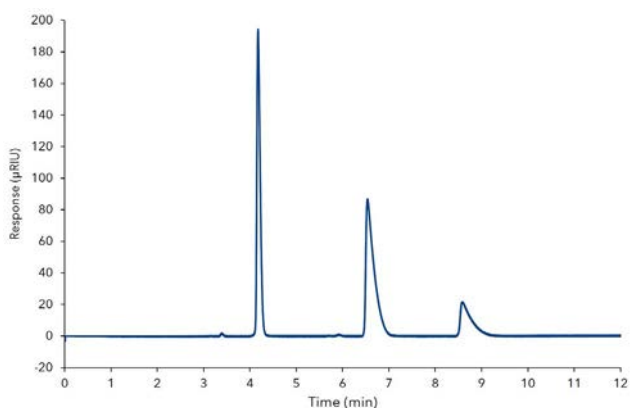


# Determination of mono- and polyaromatic hydrocarbons in diesel fuels with HPLC using RI detection

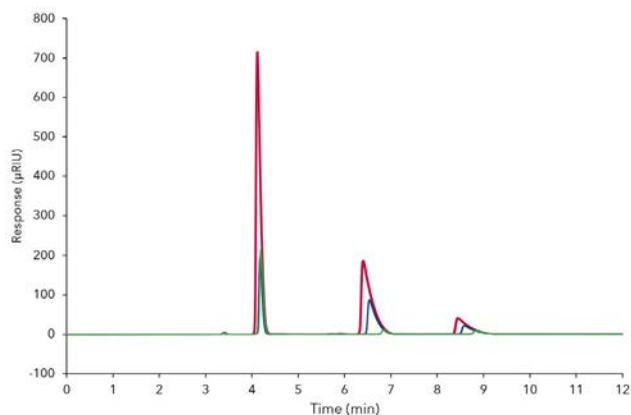
## RESULTS

The chromatographical results show that all three aromatic hydrocarbons in standard solutions were successfully separated under normal phase conditions and current instrumental settings. **Fig 1** shows the overlay of chromatograms from three repetitions. The standard deviation value for retention time and peak area is 0.05% - 0.06% and 0.09% - 0.22%, respectively (**Tab 2**). The correlation factor for all compounds, obtained due analysis of three concentration levels

(standard solutions A, C, and D) is > 0.9999. The corresponding overlay chromatograms are presented in **Fig 2**. In the chromatogram of the diesel fuel sample all three compounds could be identified (**Fig 3**). The highest amount of aromatic hydrocarbons was detected for 1,2-dimethylbenzene. The calculated value is 19.26%. The values for all three hydrocarbons are presented in **Tab 3**.



**Fig. 1** Overlay chromatogram of three replicates of standard solution C



**Fig. 2** Overlay chromatogram of two replicates each for standard solutions A (red), C (blue), and D (green)

**Tab. 1** Amount of components in m% of standard solutions A, C, and D

Compound name	Solution A	Solution C	Solution D
1,2-Dimethylbenzene	1.515	1.348	6.557
Fluorene	0.062	0.785	2.017
Phenanthrene	0.072	0.221	0.479

**Tab. 2** Reproducibility of standard solution C

Compound name	Ret. time (min)	RSD (%)	Area (µRIU-s)	RSD (%)
1,2-Dimethylbenzene	4.18	0.06	967.67	0.22
Fluorene	6.54	0.06	1067.25	0.09
Phenanthrene	8.59	0.05	355.25	0.17

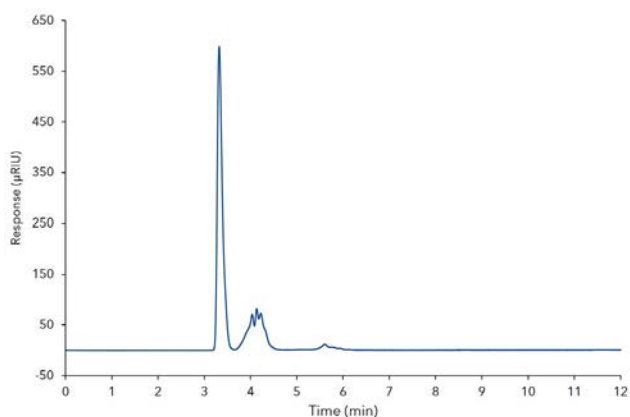


Fig.3 Chromatogram of a diesel fuel sample

Tab.3 Calculated amount of identified components in diesel fuel

Compound name	Amount (m%)
1,2-Dimethylbenzene	19.26
Fluorene	1.53
Phenanthrene	0.04

## REFERENCES

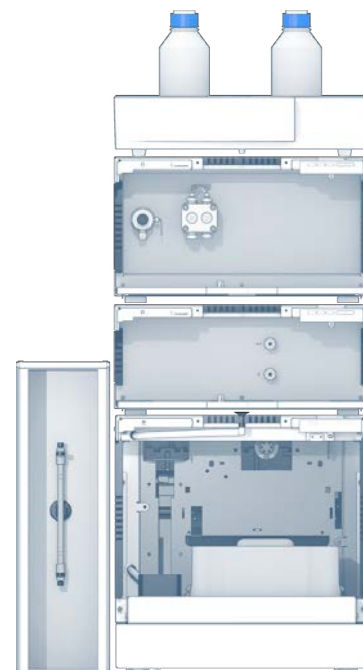
[1] DIN EN 12916:2016 Petroleum products - Determination of aromatic hydrocarbon types in middle distillates - High performance liquid chromatography method with refractive index detection, German version

## MATERIALS AND METHODS

For the analysis of mono-, and polyaromatic hydrocarbons we used the following HPLC system setup: isocratic AZURA P6.1L pump with 10 mL pump head, AZURA AS 6.1L autosampler, AZURA RID 2.1L detector and AZURA CT 2.1L thermostat. The separation was performed on normal phase column ZORBAX®, NH2 250 x 4.6 mm. The used mobile phase was n-heptane. For calibration three concentration levels were used. The amounts of 1,2-dimethylbenzene, fluorene and phenanthrene in corresponding solutions A, C and D are presented in **Tab 1**. The samples from the respective diesel fuel batches were diluted to 10% with n-Heptan and analyzed.

## CONCLUSION

This application demonstrates, that the AZURA® isocratic analytical HPLC system in combination with AZURA RID 2.1L detector suitable for determining of mono- and polyaromatic hydrocarbons in diesel fuel according to DIN EN 12916.



## ADDITIONAL MATERIALS AND METHODS

**Tab.A1** Method parameters

Eluent	n-heptane		
Gradient	isocratic		
Flow rate	1.2 mL/min	Run time	12 min
Column temperature	25 °C	Injection mode	Full loop
Injection volume	5 µL	Data rate	10 Hz
Detection	RI		

**Tab.A2** System configuration

Instrument	Description	Article No.
Pump	AZURA® P6.1L	<a href="#">APH30ED</a>
Autosampler	AZURA® AS 6.1L	<a href="#">AAA00AA</a>
Detector	AZURA® RID 2.1L	<a href="#">ADD31</a>
Column	ZORBAX®, NH2 250 x 4.6 mm	
Thermostat	AZURA® CT 2.1	<a href="#">A05852</a>
Software	ClarityChrom 7.2	<a href="#">A1670-11</a>

## RELATED KNAUER APPLICATIONS

[VEV0078](#) - Systematic HPLC Method Development and Robustness Evaluation of 13 Carbonyl DNPH Derivatives Using DryLab®

[VEV0081](#) - GPC vs. SPE and subsequent determination of polycyclic aromatic hydrocarbons using GC/MS



# GPC vs. SPE and subsequent determination of polycyclic aromatic hydrocarbons using GC/MS



Hagen Schlicke<sup>1</sup>, Max von Delbrück<sup>1</sup>, A.Bertin<sup>2</sup>, S.Iacobellis<sup>2</sup>, T.Bonato<sup>2</sup>, S.Guidotti<sup>3</sup>,  
Kate Monks<sup>1</sup>; applications@knauer.net

<sup>1</sup>KNAUER Wissenschaftliche Geräte GmbH, Hegauer Weg 38, 14163 Berlin; www.knauer.net

<sup>2</sup>Laboratorio di ricerca S.E.S.A., Italy, <sup>3</sup>Labservice Analytica S.R.L, Italy

## SUMMARY

Polycyclic aromatic hydrocarbons (PAHs) are of great importance as pollutants in the environment because of their persistence, their toxicity, and their ubiquitous spread. The AZURA® GPC Cleanup system automates work-intensive and time-consuming cleanup tasks based on gel permeation chromatography (GPC). The improved reproducibility and quality of the cleanup leads to a robust application for determination of PAHs using GC/MS analysis.

## INTRODUCTION

Polycyclic aromatic hydrocarbons (PAHs) are ubiquitous environmental pollutants generated primarily during the incomplete combustion of organic materials. The removal of PAHs from the atmosphere by dry and wet deposition processes are strongly influenced by their gas/particle partitioning. Atmospheric deposition is a major source for PAHs in soil [1] which can be determined by various extraction and purification processes, subsequently detected by a GC/MS using the reference method UNI EN 15527. Our main purpose is to demonstrate that the purification of

environmental matrix with high organic component using the gel permeation chromatography purification (AZURA GPC Cleanup, FS conditioned resins CHEX/DCM), compared to a SPE purification, allows are well-defined separation time of the analytes and it can provide narrow bands without their physical chemical interaction with the column, resulting in less chance of loss of analytes [2]. This differs from other separation techniques which depend upon chemical or physical interactions to separate analytes [3].



# GPC vs. SPE and subsequent determination of polycyclic aromatic hydrocarbons using GC/MS

## RESULTS

The comparison of analytical chromatograms obtained from GC-MS serve the evaluation of the baseline (Fig 1a). The overlays result obtained clearly confirm that the signal-to noise (S/N) and also the matrix effect of the sample is broadly reduced with

the GPC purification compared with the SPE purification (Fig 1b). The GPC purification procedure allows also an improvement for the identification of the third mass (Fig 2).

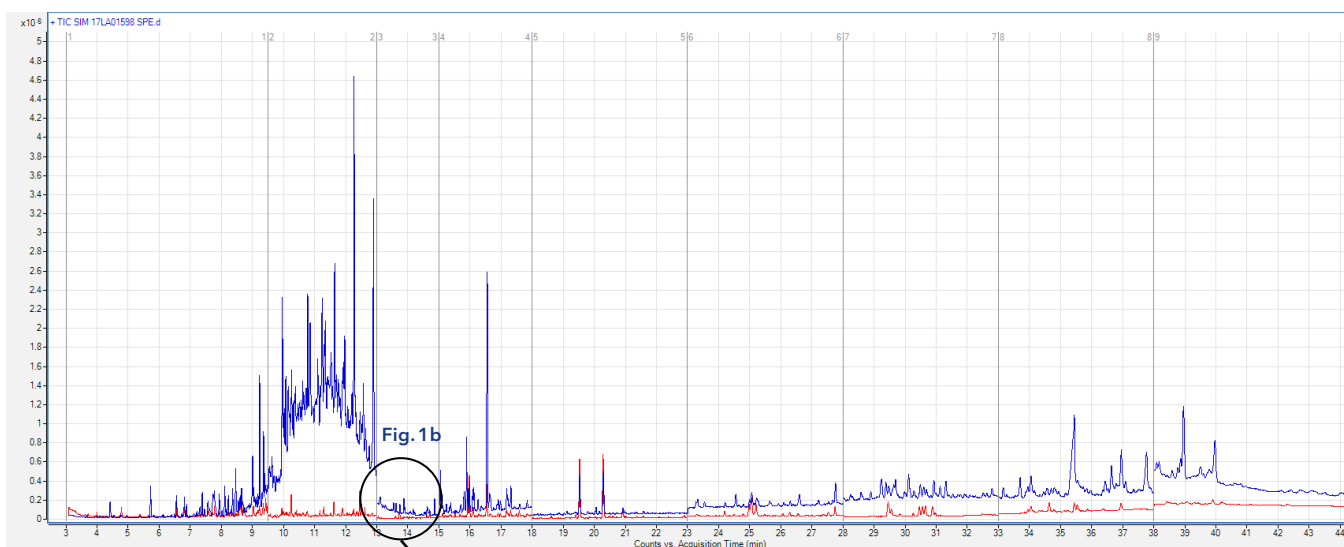


Fig. 1a Overlay of chromatograms obtained from GC-MS; blue - SPE, red - GPC

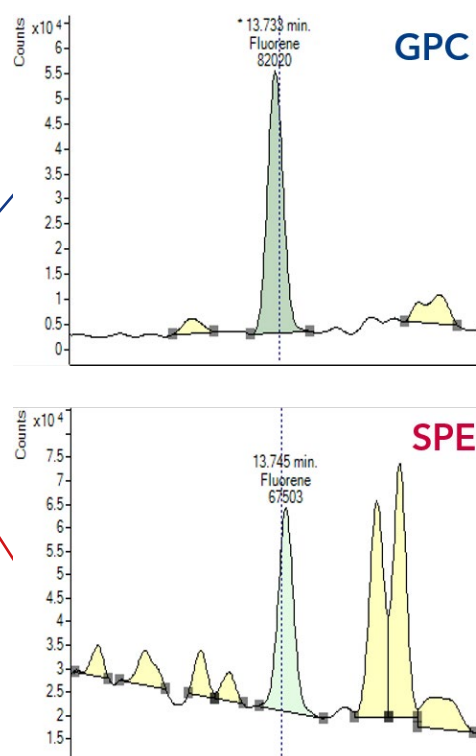


Fig. 1b Selected ion 166,1 (Fluorene)

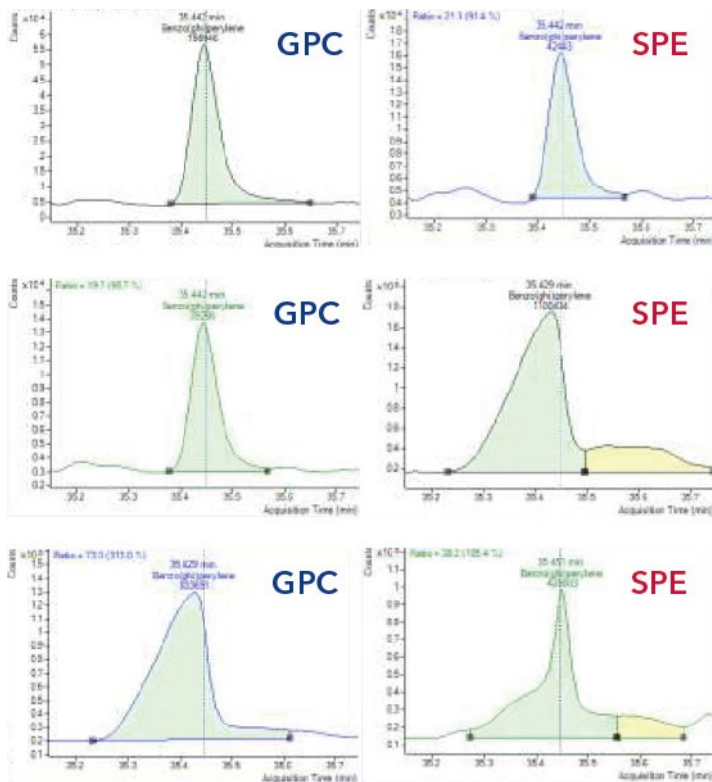


Fig.2 Identification of the third mass

## MATERIALS AND METHODS

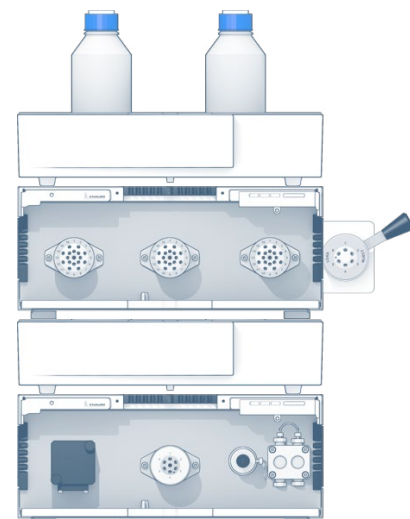
For the purification procedure a mud sludge sample (20 g) of civil waste was used. The analysis is based on UNI EN 15527: 2008 Determination of polycyclic aromatic hydrocarbons (PAH) in waste by gas chromatography with mass spectrometric detection (GC /MS). Extraction technique information: Soxhlet extraction (BUCHI B-811 system:100 extraction cycles with Acetone/Hexane - 1/1 v/v). Cleanup information: AZURA GPC Cleanup system; GPC column: 450 mm x 10 mm Phase: Biobeads SX3 - 10g; Mobile Phase: CEX/DCM - 70/30 (v/v); Flow rate: 1 mL/min Injected volume: 1 mL (concentrated sample corresponding to 4 g of sample). After Cleanup the sample volume has been reduced to 1 mL by evaporation. The extract is concentrated to minimum volume and diluted to 5 mL with GPC mobile phase. For the analysis a GC-MS single quadrupole 5975C (Agilent) was used and a volume of 1 µL was injected.

## CONCLUSION

The GPC cleanup procedure of mud sludge samples prior analysis of PAHs with GC/MS technique is a good alternative to SPE purification steps. Advantages like better S/N ratios and third mass identification are obvious. The automatization of the GPC Cleanup using AZURA GPC Cleanup system yields high efficiency of the application.

## REFERENCES

- [1] Hussein I. Abdel-Shafy, Mona S.M. Mansour. Egyptian Journal of Petroleum (2015)
- [2] A. Bertin, S.Iacobellis, T.Bonato, Laboratorio di ricerca S.E.S.A., S.Guidotti, Labservice Analytica S.R.L
- [3] Skoog, D.A. Principles of Instrumental Analysis, 6° ed.; Thompson Brooks/Cole: Belmont, California, 2006 , Chapter 28.



## ADDITIONAL MATERIALS AND METHODS

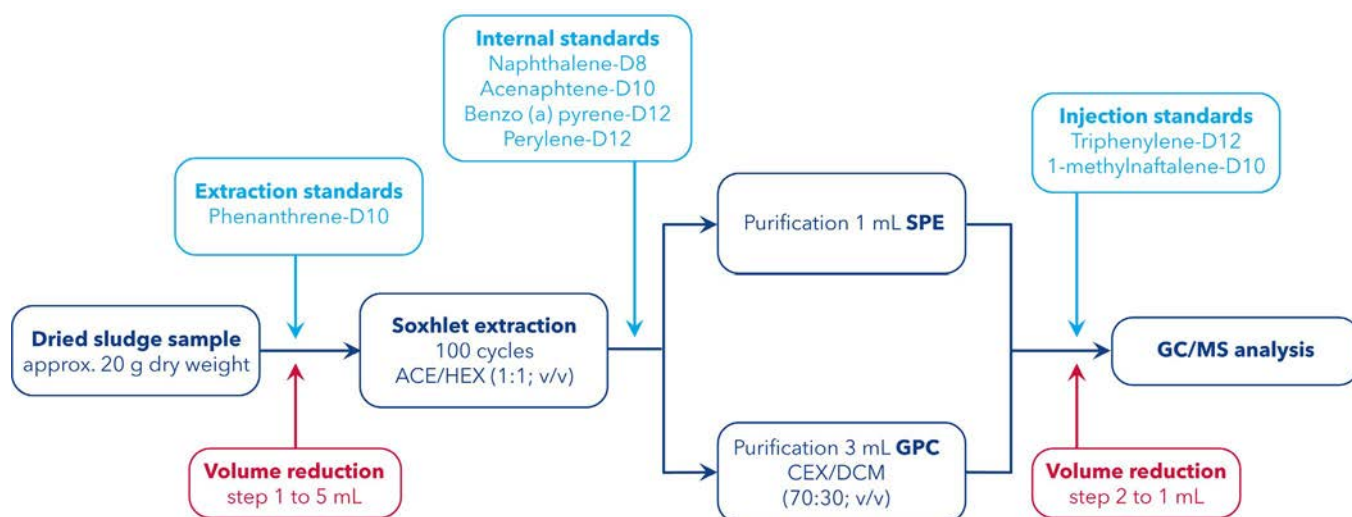


Fig. A1 Scheme of analytical method

Tab. A1 System configuration

Instrument	Description	Article No.
Pump & detector	AZURA Assistant ASM 2.1L	<a href="#">AYCAEABM</a>
Loops & fractionation	AZURA Assistant ASM 2.1L	<a href="#">AYGAGAGA</a>
Eluent tray	AZURA Eluent tray E 2.1L	<a href="#">AZC00</a>
Tubing guide	AZURA GPC tubing guide 1 ml	<a href="#">A5329-2</a>
Flow cell	Semi-preparative UV Flow Cell	<a href="#">A4042</a>
Injection valve	AZURA V 2.1S valve	<a href="#">AVI26BC</a>
Mounting bracket	Mounting bracket AZURA L	<a href="#">A9853</a>
Software	Mobile Control Chrom with tablet	<a href="#">A9608</a>



AZURA® GPC Cleanup system with Mobile Control

## RELATED KNAUER APPLICATIONS

[VFD0153](#) - GPC Cleanup of olive oil samples

[VFD0146](#) - Sensitive online SPE determination of bisphenol A in water samples

[VFD0152](#) - Determination of aflatoxin M1 in milk

# GPC cleanup method for soil samples before PAHs analysis



Federica Massari\*\*, Lilit Avagyan\*, Matthias Lübbert\*, Kate Monks\*, Pietro Cotugno\*\*, Carlo Zambonin\*\*, Antonella Aresta\*\*, applications@knauer.net

\*KNAUER Wissenschaftliche Geräte GmbH, Hegauer Weg 38, 14163 Berlin; www.knauer.net

\*\* Department of Chemistry, University of Bari "Aldo Moro", Via Orabona, 4, 70126 Bari, Italy

## SUMMARY

This work is focused on the development of a clean-up method with the AZURA® GPC Cleanup system to purify soil sample extracts before analysis. It was found that GPC cleanup is very useful to remove interferences from extracted soil samples before GC-MS/MS determination of semi-volatile organic compounds, like Polycyclic Aromatic Hydrocarbons. Moreover, the described method enables to perform an automated clean-up procedure and hence to purify many samples efficiently.

## INTRODUCTION

GPC (Gel Permeation Chromatography) is a size-exclusion clean-up procedure that readily separates high molecular weight interferences from sample extracts using organic solvents and a porous hydrophobic gel (primarily a crosslinked divinylbenzene-styrene copolymer) [1]. It is possible to distinguish between different types of Bio-Beads resin based on the type of cross-linkage. In this application Bio-Beads S-X3 with 200–400 mesh was used according to EPA method 3640 [1]. GPC clean-up can be used extensively in numerous environmental analysis especially

for preparing sample extracts prior to semivolatile compounds determination, such as pesticide, and PAHs analysis by GC/MS or HPLC-UV-DAD. Sample cleanup is particularly important for analytical separations such as GC, HPLC, and electrophoresis because high-boiling materials can cause a variety of problems in analytical systems, like analyte adsorption in the injection port or in front of a GC or LC column [2]. GPC cleanup protects GC and HPLC columns, reduces analytical maintenance costs, improves accuracy, and allows lower detection limits.



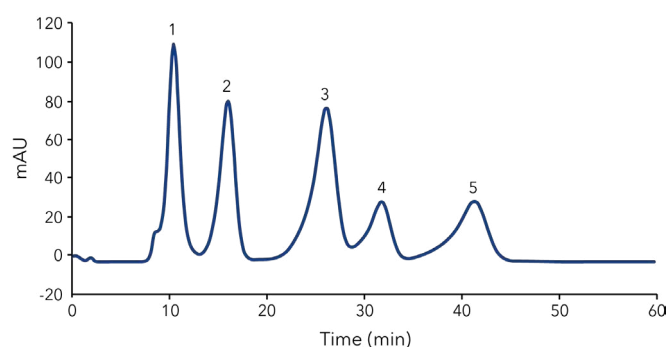
# GPC cleanup method for soil samples before PAHs analysis

## RESULTS

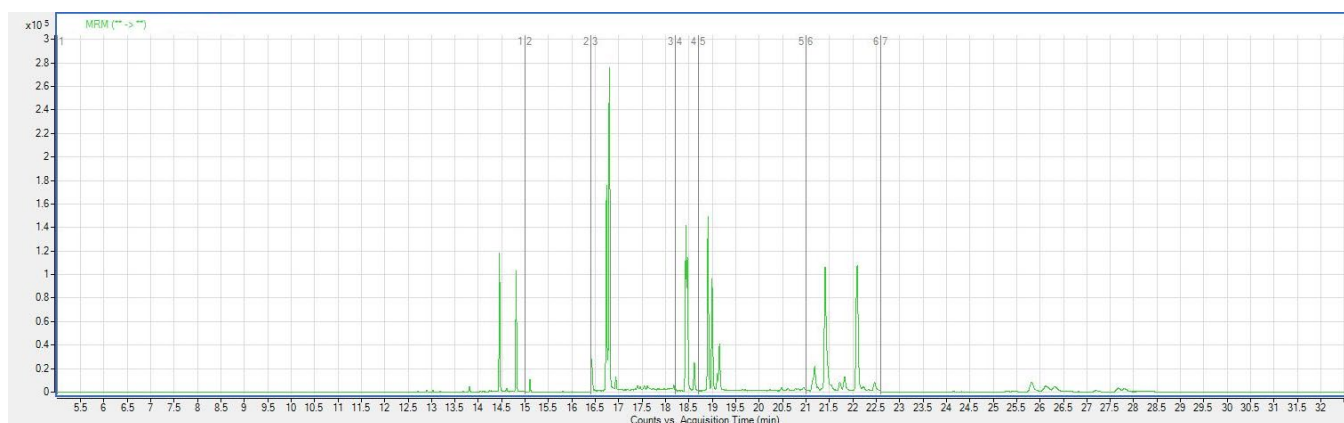
The calibration of the AZURA® GPC Cleanup System was performed with a calibration mixture in dichloromethane containing the following compounds also reported in EPA method 3640: corn oil, methoxychlor; phthalic acid, bis-2-ethylhexyl ester (ester of phthalic acid), perylene, and sulfur [1]. 1 mL calibration standard was diluted with 2 mL dichloromethane and 7 mL cyclohexane to resemble the mixture similar to the mobile phase for GPC. 2 mL solution were injected and calibration test was carried out for 60 min at a flow rate of 1 mL/min.

In **Fig. 1** the chromatogram of diluted calibration mixture solution is reported. According to 3640 EPA method, a reagent blank should be analyzed for the compounds of interest prior to the use of the clean-up method [1]. The level of interferences must be below the estimated quantitation limits of the analytes before the method is performed on samples. Using the information coming from the detector, it could be possible to establish appropriate collect time periods for target analytes. 3640 EPA method suggests to initiate column collection just before elution of bis-(2-ethylhexyl) phthalate, after the elution of the corn oil and to stop eluate collection shortly after the elution of perylene, in order to ensure semi-volatiles

collection [1]. In particular, a recovery test was performed using PAH standard solution and it was observed that the proper collection time ranged from 18 to 45 min to ensure a good recovery efficiency for the analytes of interest. GPC cleanup method was successfully applied to different soil samples' extracts derived from the Environmental Chemistry Laboratory of the Department of Biology, University of Bari (separate branch of Taranto, Italy). After performing clean-up method on the selected samples, they were concentrated under nitrogen stream and ready to perform analytical determination.



**Fig. 1** Chromatogram of a diluted calibration mixture solution 1) Corn oil (5 mg/mL), 2) Phthalic acid, bis-2-ethylhexyl ester (1 g/L), 3) Methoxychlor (0.2 g/L), 4) Perylene (0.02 g/L), 5) Sulfur (0.08 g/L)



**Fig. 2** GC-MS/MS chromatogram of purified soil sample: determination of PAHs

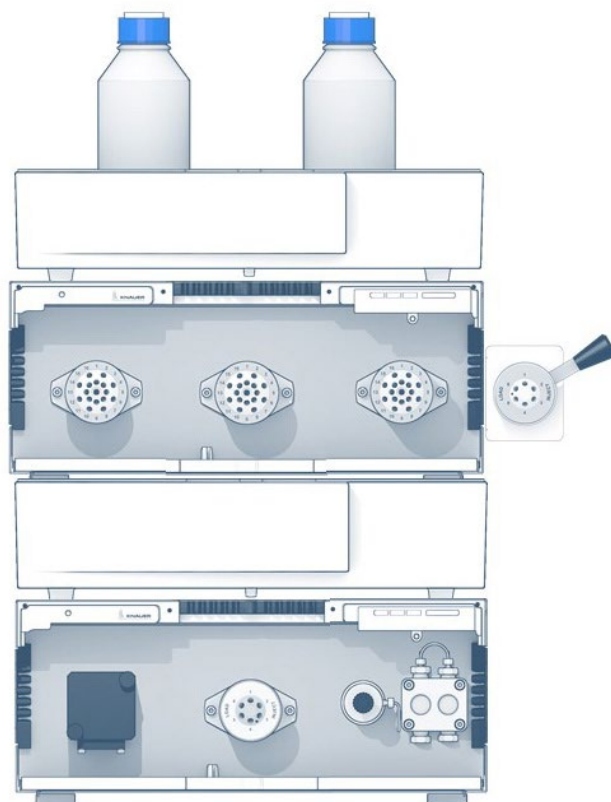
## MATERIALS AND METHOD

Extraction of Polycyclic Aromatic Hydrocarbons was carried out using Accelerated Solvent Extraction (ASE), according to the 3545A EPA method [3]. Bio-Beads S-X are supplied dry and must be swollen prior to pack into a chromatographic column. A mixture of cyclohexane and dichloromethane (70:30, v:v) is suitable for clean-up of soil samples. As a general rule, the beads should be swollen in the same solvent chosen as mobile phase, so 10 g of Bio-Beads S-X3 were swelled with 50 mL of cyclohexane and dichloromethane mixture (70:30, v:v) overnight. After the beads were fully swollen, they were packed into a chromatographic column. Before sample cleanup, GPC column was

equilibrated with the desired solvent mixture, flushing it almost three times the column volume at 1 mL/min. Cleanup method was performed with AZURA® GPC Cleanup System, which is operated with the Mobile Control Chrom® Software running on a tablet directly mounted on the system. The identification and quantification of PAHs was carried out by GC-MS/MS analysis. Calibration curves were constructed in the concentration range from 10 µg/L to 130 µg/L. To perform GC separation and MRM acquisition, optimization of the best chromatographic and detection conditions was necessary.

## CONCLUSION

This application shows how to perform GPC cleanup with KNAUER AZURA® GPC Cleanup System for the analysis of PAHs in soil samples. This report is very detailed to ensure good performance in GPC cleanup for application in environmental area. We can conclude that AZURA GPC Cleanup System is a helpful tool for sample preparation before instrumental analysis because, unlike other techniques, is very useful for the removal of high boiling materials which would contaminate injection ports and column heads, prolonging column life, stabilizing the instrument, and reducing column reactivity. It could be considered an universal cleanup technique for a broad range of semivolatile organics and pesticides. Moreover, AZURA GPC Cleanup System allows the customer to process many extracted samples, with a reduction in time for the cleanup procedures.



## REFERENCES

[11] EPA Method 3640A: Gel-Permeation Cleanup

[12] J. D. Winefordner. Chemical analysis: a series of monographs on analytical chemistry and its applications. Vol. 162, p.21 -25

[13] EPA Method 3545A: Pressurized Fluid Extraction (PFE)

## ADDITIONAL MATERIALS AND METHODS

**Tab.A1** ASE Method parameters

Temperature	100°C
Pressure	1500 psi
Static time	5 min
Cycles	1
Purge	60 s
Solvent	Hexane/DCM (1:1, v:v)
Cell volume	34 mL

**Tab.A2** GPC Method parameters

Eluent A	Cyclohexane/Dichloromethane (70:30, v/v)		
Gradient	isocratic 100 % A		
Flow rate	1 mL/min	System pressure	35 psi
Column temperature	RT	Run time	60 min
Injection volume	2 mL	Injection mode	Full loop
Detection wavelength	254 nm	Data rate	10 Hz
Collect time	18-43 min	Time constant	0.1 sec

**Tab.A3** System configuration (GPC Cleanup system)

Instrument	Description	Article no.
Injection valve	Manual injection valve 6-port 2-position	<a href="#">AVI26BC</a>
Assistant 1	AZURA ASM 2.1 L left: single variable wavelength UV detector middle: 6 port column bypass valve right: pump with pressure sensor, 10 mL pump head in SST	<a href="#">AYCAEABM</a>
Assistant 2	AZURA ASM 2.1 L left: 16 port multi position valve for fractioning middle: 16 port multi position valve for sample loop right: 16 port multi position valve for sample loop	<a href="#">AYGAGAGA</a>
Flow cell	UV, 3 mm, 2 µL	<a href="#">A4042</a>
GPC tubing guide	16 sample loops with 1 mL	<a href="#">A5329-2</a>
Column	450 mm length, 10 mm ID Resin Bio Beads SX-3	
Software	Mobile control	<a href="#">A9608</a>

**Tab.A4** GC-MS/MS method

Injector	Split/Splitless	
Mode	Splitless	
Injector temperature	280°C	
Injection volume	2 µL	
Flow rate	1 mL/min	
Carrier gas	Helium	
Capillary column	HP-5MS 30 m x 250 µm x 0.25 µm	
Oven temperature program	80° for 3 minutes from 80 to 300°C at 15°C/min 15 min at 300°C	
Transfer line temperature	300°C	
Electron impact mode	Positive ion	
Solvent delay	5 minutes	
Source temperature	280°C	
Quadrupole Temperature	150°C	
Scan type	MRM, multiple reaction monitoring	
QQQ Collision cell	Quench gas flow rate	2.25 mL/min
	Collision gas flow rate	1.5 mL/min

## RELATED KNAUER APPLICATIONS

[VFD0153](#) - GPC Cleanup of olive oil samples

[VEV0081](#) - GPC vs. SPE and subsequent determination of polycyclic aromatic hydrocarbons using GC/MS

[VFD0166](#) - LC-FLD analysis of 4 PAHs in olive oil samples using AZURA® GPC Clean-up System



# Sensitive and selective analysis of wood sugars and uronic acids for biofuel research with electrochemical detection

Kristin Folmert, Jan Wendrich, Kate Monks; applications@knauer.net  
KNAUER Wissenschaftliche Geräte GmbH, Hegauer Weg 38, 14163 Berlin;  
www.knauer.net



## SUMMARY

Monosaccharides belong to the most abundant group of biomolecules in nature. They play a crucial role in metabolism, structural biology, and storage of energy. Thus, the analysis of these special type of carbohydrates is of great interest for the food industry but also for a broad range of life and material sciences. The presence of hydroxyl groups enables a specific and highly sensitive analysis using pulsed amperometric detection (PAD) with the DECADE Elite electrochemical detector as part of the dedicated AZURA® High Performance Anion Exchange Chromatography (HPAEC) system.

## INTRODUCTION

The sources for the different kinds of monosaccharides can vary between food samples like honey [1] or fruits, to scientific applications like glycopeptides or they can be products of fermentation processes like the here analysed wood monosaccharides. The mixture of the seven hemicellulosic sugars fucose, rhamnose, arabinose, galactose, glucose, xylose and mannose mixed with the two uronic acids galacturonic acid and glucuronic acid, extracted from wood by heat or chemical pretreatment, are of special interest in the research for new biofuels. They are considered

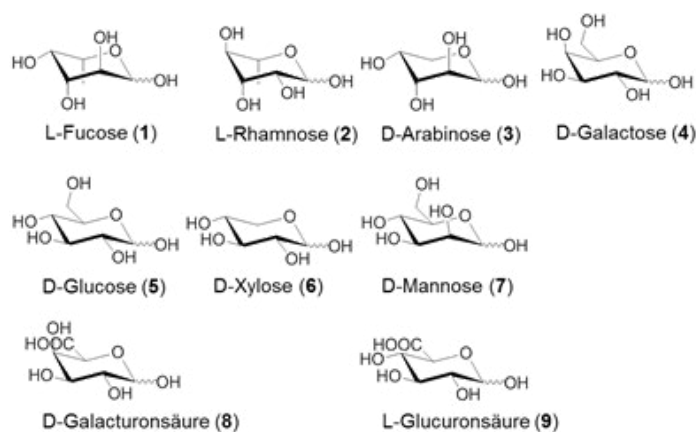
to be more sustainable and are expected to become a competitive commercial alternative to fuel made from corn and other food sources [2]. Carbohydrates are weak acids with pKa values between 12 and 14. Consequently, they can be completely or partially ionized under basic conditions with pH >12. Due to these harsh conditions, only polymeric anion exchange columns are suitable for the monosaccharide analysis. The retention time with AZURA HPAEC is inversely correlated with pKa value and increases significantly with molecular weight of the monosaccharide.



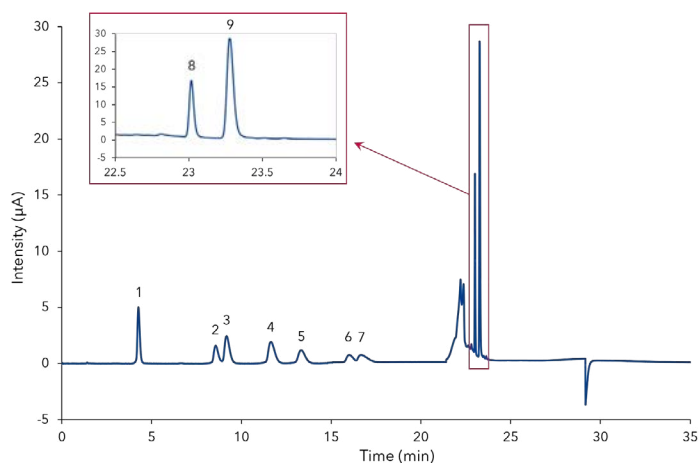
# Sensitive and selective analysis of wood sugars and uronic acids for biofuel research with electrochemical detection

## RESULTS

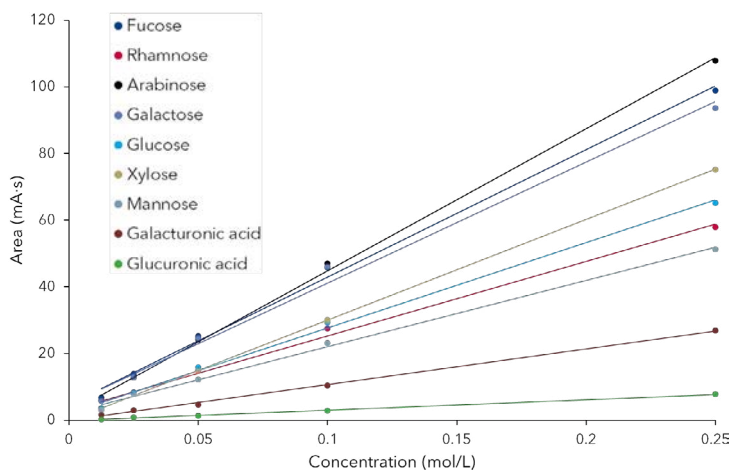
Using an analyte concentration of 0.1 mg/mL for the standard mixture of the nine wood monosaccharides and acids, all components could be baseline-separated ( $R_s > 1.5$ ) (Fig 1). The separation of the analyte peaks increases with decreasing sample concentration. The two monosaccharides xylose (6) and mannose (7) could not be baseline-separated with concentrations higher than 0.1 mg/mL. The signal to noise (S/N) ratio for each analyte was calculated from empiric data (Tab 1). Noise values were determined for this concentration from two different baseline areas. For the monosaccharide sugars 1-7 the averaged noise was determined with 0.001  $\mu\text{A}$  and for the uronic acids 8-9 a value of 0.1  $\mu\text{A}$  was determined. Concentration curves of all analytes from 0.0125 to 0.25 mg/mL are depicted in Fig 2.



Pyranose structure of the seven wood monosaccharides and the two uronic acids



**Fig. 1** Chromatogram of a standard mixture containing 0.1 mg/mL fucose (1), rhamnose (2), arabinose (3), galactose (4), glucose (5), xylose (6), mannose (7), galacturonic acid (8) and glucuronic acid (9). And a zoom into the peaks for the uronic acids



**Fig. 2** Concentration curves of the described sugars and uronic acids in a concentration range between 0.0125 mg/mL to 0.25 mg/mL

Analyte	S/N
L-fucose	10000
L-rhamnose	3000
L-arabinose	4800
D-galactose	3800
D-glucose	2400
D-xylose	1600
D-mannose	1600
D-galacturonic acid	338
D-glucuronic acid	574

**Tab. 1** Empiric determined S/N ratios for a 10  $\mu\text{L}$  injection

## MATERIALS AND METHODS

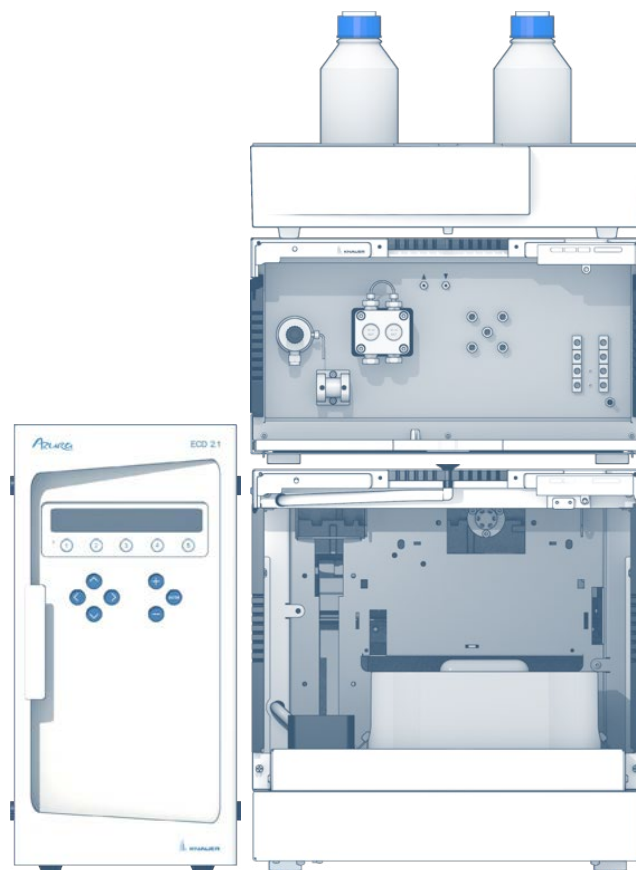
An AZURA glass- and metal-free High Performance Anion Exchange Chromatography (HPAEC) system was used. It was comprised of an AZURA P 6.1L LPG pump, an AZURA AS 6.1L autosampler and a DECADE Elite electrochemical detector which was also used for column tempering. The analysis was based on a step-gradient with different concentrations of NaOH solution (**Tab A2 & A3**, additional material). While working with low concentrations of NaOH, carbonate ions, present in the mobile phase, can bind to the column material and thereby decrease separation efficiency. Hence, a column regeneration with higher concentrations of NaOH is recommendable for each run. Furthermore, during eluent preparation the contamination with carbonate ions should be minimized by using carbonate-free 50 % w/w NaOH solution (commercially available) and an ultrasonic degassing step before the introduction into the system. Eluents should be completely refreshed daily. With respect to the high sensitivity of the DECADE Elite detector and the etching property of the NaOH, only plastic eluent bottles, plastic eluent filters and metal-free system compartments should be used to prevent the detection of unexpected ions, silicates or borates. For detection an Antec electrochemical SenCell with Au working electrode, HyREF (Pd/H<sub>2</sub>) reference electrode and stainless steel auxiliary electrode was used with a 4-step potential waveform (**Fig A1**, additional material).

## REFERENCES

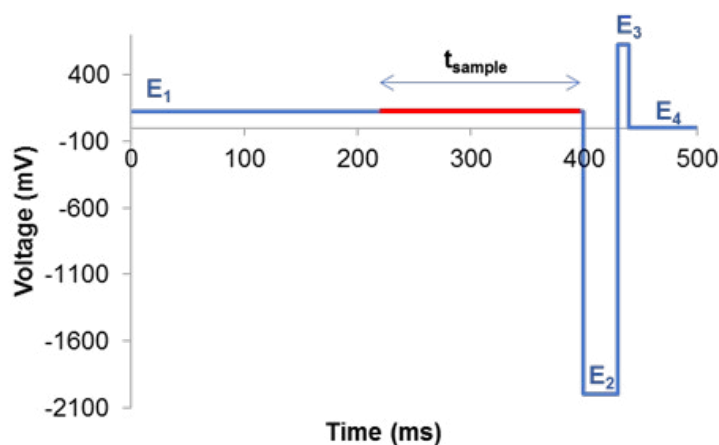
- [1] H. Schlicke, K. Monks, KNAUER AppNote VFD0161, 2017
- [2] M. J. González-Muñoz, R. Alvarez, V. Santos, J. C. Parajó, Wood Science and Technology, 2012, 46, 1-3, 271-285.

## CONCLUSION

High Performance Anion Exchange Chromatography (HPAEC) with pulsed amperometric detection (PAD) using the AZURA HPAEC-PAD dedicated system and applying the developed method is a highly sensitive setup for the analysis of sugar monosaccharides and other carbohydrates. The mixture of seven monosaccharides and two uronic acids could be baseline-separated with very high S/N ratios. An easy to perform method using different concentrations of NaOH allows a fast and reproducible analysis even in low concentrations. Besides the research for biofuels, the investigated sugars are components in numerous processes in nature and food applications. Thus, the current application is suitable for several issues where carbohydrates need to be specifically separated and analyzed.



## ADDITIONAL MATERIALS AND METHODS



**Fig. A1** 4-step PAD potential waveform for the detection of mono-saccharides and other carbohydrates. The sample detection occurs during the highlighted time period  $t_{\text{sample}}$ .

**Tab. A1** Method parameters

Eluent A	Water		
Eluent B	200 mM NaOH		
Eluent C	700 mM NaOH		
Flow rate	0.4 mL/min	Pressure	220 bar
Run temperature	40°C	Run time	35 min
Injection volume	10 $\mu$ L	Injection mode	Full loop
Detection wavelength	ECD (40°C)	Data rate	2 Hz
		Time constant	0.2 sec

**Tab. A3** System configuration

Instrument	Description	Article No.
Pump	AZURA® P6.1L, LPG 10 mL bio inert	<a href="#">APH39EA</a>
Autosampler	Autosampler AS 6.1L bio inert	<a href="#">AAA20AA</a>
Detector	Electrochemical Detector DECADE Elite SCC with SenCell Au HyREF	<a href="#">A07545</a> <a href="#">A07546-3</a>
Column	Dionex™ CarboPac™PA20 250x4mm	<a href="#">B08154-1</a>
Precolumn	CarboPac™PA20 30x3mm	<a href="#">B081517</a>
Software	ClarityChrom 7.4.2	<a href="#">A1670</a>

**Tab. A2** Gradient method description

Time (min)	A (%)	B (%)	C (%)	Flow (mL/min)
0.00	100	0	0	0.4
11.00	100	0	0	0.4
11.02	98.8	1.2	0	0.4
19.98	98.8	1.2	0	0.4
20.00	30	0	70	0.4
25.00	30	0	70	0.4
25.50	100	0	0	0.4
35.00	100	0	0	0.4

## RELATED KNAUER APPLICATIONS

[VFD0062J](#) - Fat soluble Vitamins by HPLC with electrochemical detection

[VFD0161](#) - Determination of sugars in honey using HILIC separation and RI detection

# Sensitive online SPE determination of bisphenol A in water samples

Juliane Böttcher, Kate Monks; [applications@knauer.net](mailto:applications@knauer.net)

KNAUER Wissenschaftliche Geräte GmbH, Hegauer Weg 38, 14163 Berlin; [www.knauer.net](http://www.knauer.net)



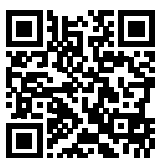
## SUMMARY

In this application a method for the sensitive determination of bisphenol A (BPA) from water samples is presented. The use of online solid phase extraction (SPE) coupling avoids time consuming and manual sample preparation steps, making the method well-suited for routine analyses of BPA in low concentration samples like drinking water.

## INTRODUCTION

Solid phase extraction is an effective preparation method for concentrating analytes prior to HPLC analysis. Classically, this method is done offline via time consuming steps. The advantages of online coupling result in a reduction of analysis time, sample contamination and analyte loss. This automated method is perfectly suited for pre-concentration of BPA in drinking water. The main source for BPA is the industrial production of polycarbonates and polyvinyl

chloride (PVC) where it is a major constituent. It is also an important monomer in the production of polycarbonate. BPA is known for its endocrine effects similar to the hormone estrogen even at very low dosage and is associated with environmental and health problems. Based on previous studies a maximum entry  $<1 \mu\text{g/mL}$  in cold drinking water is expected. In warmed-up water ( $70^\circ\text{C}$ ) a concentration up to  $30 \mu\text{g/mL}$  is possible.

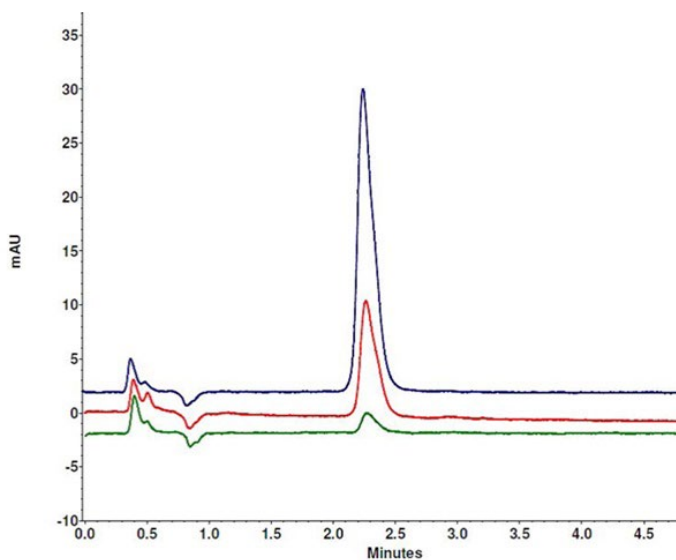


# Sensitive online SPE determination of bisphenol A in water samples

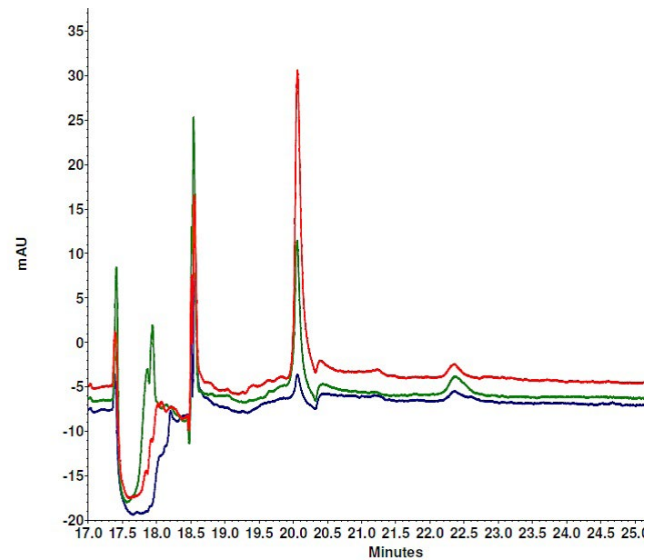
## RESULTS

After calibration by direct injection using an auto-sampler, the recovery rate is determined with the online SPE column in the flow path. Differing concentrations down to 0.07 ng/mL have been extracted from prepared water samples with constant extraction time. **Fig 1** shows the chromatogram of three different

concentrations with same online SPE extraction time. **Fig 2** shows an original drinking water sample spiked with BPA. Afterwards the extraction time was varied using a solution with a constant concentration of 0.1 ng/mL. A recovery rate of 98 % for BPA was found.



**Fig. 1** To determine the recovery rate of calibration points, two different methods are taken as a basis. First three differing concentration ( $c_1=0.07$  ng/mL,  $c_2=0.4$  ng/mL,  $c_3=1$  ng/mL) have been extracted with the same extraction time. In this part recovery rates of 93 % for bisphenol A were found ( $n=4$  for each concentration).



**Fig. 2** Chromatogram of three different concentrations with same online SPE extraction time.

## MATERIALS AND METHODS

An AZURA® Analytical HPLC Plus system was used for this application. It consists of an AZURA P 6.1L LPG pump, an autosampler 3950, an AZURA CT 2.1 column thermostat, a AZURA MWD 2.1L multi wavelength detector and an assistant AZURA ASM 2.1L equipped with a 12 port multi position valve, a 6 port/2 position injection valve and a pump with 10 mL pump head. The analytical method runs isocratic at a flow rate of 0.6 mL/min with a mixture of acetonitrile and water 50:50 (v/v). The column thermostat was set to 30 °C and the detector recorded at 227 nm.

The used columns are filled with KNAUER Eurospher II 100-3 C18A silica. The SPE method parameters are divided into different steps, including column conditioning, sample extraction, sample analysis, and reconditioning of the SPE column.

## CONCLUSION

The method presented in this application note is well suited for the analysis of bisphenol A in water samples like drinking water and allows varying the extraction time dependent on the expected bisphenol A concentration. For a higher and better evaluable peak signal the time the sample flushes over the extraction cartridge can simply be increased. With this sensitive method it is possible to successfully quantify even low concentrated samples and extracts and equipped with the AZURA ASM 2.1L the system can easily be used in continuous operation.

## REFERENCES

- [1] Ligang Chen, Hui Wang, Qinglei Zeng, Yang Xu, Lei Sun, Haoyan Xu, Lan ding, "Online Coupling of Solid-Phase Extraction to Liquid Chromatography—A Review", Journal of Chromatographic Science, Vol. 47, September 2009
- [2] Jordáková I., Dobiás J., Voldrich M., Poustka J. Determination of Bisphenol A, Bisphenol F, Bisphenol A diglycidyl Ether and Bisphenol F Diglycidyl Ether migrated from food cans using Gas Chromatography- Mass spectrometry. Czech J. Food Sci.2003 Vol. 21, No. 3: 85-90
- [3] Umweltbundesamt, Abteilung Umwelthygiene. Telegramm: Umwelt + Gesundheit. „Bisphenol A“ - Wir haben ein Problem. Ausgabe 04/2008
- [4] Umweltbundesamt, Pressestelle „Bisphenol A Massenschmickalie mit unerwünschten Nebenwirkungen“, aktualisierte Fassung Juli 2010,  
[http://www.umweltbundesamt.de/uba-infomedien/mysql\\_medien.php?anfrage=Kennnummer&Suchwort=3782](http://www.umweltbundesamt.de/uba-infomedien/mysql_medien.php?anfrage=Kennnummer&Suchwort=3782)



## ADDITIONAL RESULTS

Tab. A1 SPE Parameters

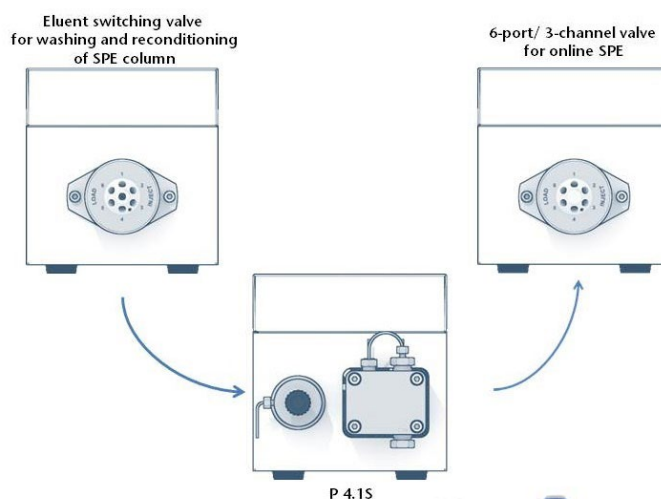
Step 1 (sample extraction)	Flush the extraction column with 100 % water for 0.5 min at a flow rate of 3 mL/min
Step 2	Switch to the sample and extract it for 15 min (variable) with a flow rate of 3 mL/min
Step 3	Flush again with 100% water for 1.5 min at a flow rate of 3 mL/min
Step 4 (sample analysis)	Switch the extraction column into the determination part of the HPLC system for 3 min, starting the data acquisition immediately after switching
Step 5 (extraction column cleaning)	After switching back, flush with 100 % acetonitrile for 3 min at a flow rate of 3 mL/min
Step 6	Flush with water at a flow rate of 3 ml/min for 5 min and then at a flow rate of 0.5 mL/min until the end of method

## ADDITIONAL MATERIALS AND METHODS

Tab. A2 Method parameters

### Analytical

Eluent A	Water		
Eluent B	Acetonitrile		
Gradient	Isocratic 50 % B		
Flow rate	0.6 mL/min	System pressure	approx. 230 bar
Column temperature	30 °C	Run time	5 min
Injection volume	10 µL	Injection mode	Full loop
Detection wavelength	227 nm	Data rate	20 Hz
		Time constant	0.05 s



Tab. A3 System configuration & data

Instrument	Description	Article No.
Pump	AZURA P 6.1L, LPG 10ml, SSt	<a href="#">APH34EA</a>
Autosampler	Autosampler 3950	<a href="#">A50070</a>
Detector	AZURA MWD 2.1L	<a href="#">ADB01</a>
Flow Cell	LightGuide 50mm, 6µL	<a href="#">AMD59</a>
Assistant	AZURA ASM 2.1L, left: 12 port multi position valve, 1/8" connectors middle: 6 port 2 position injection valve, 1/16" connectors right: pump with pressure sensor, 10 mL pump head, SSt	<a href="#">AYFAEABA</a>
Thermostat	AZURA CT 2.1 Column Thermostat	<a href="#">A05852</a>
Eluent tray	AZURA ET 2.1L	<a href="#">AZC00</a>
Column	Vertex Plus Column, 100x3 mm ID, Eurospher II 100-3 C18A	<a href="#">10CE184E2G</a>
Column SPE	Vertex Plus Column, 30x4 mm ID, Eurospher II 100-3 C18A	<a href="#">03DE184E2G</a>
Software	OpenLAB CDS EZChrom Edition	<a href="#">A2600-1</a>



Dedicated AZURA® Online SPE System



# Alternative xylitol extraction via hplc purification from fermented biomass

Yannick Krauke, Hagen Schlicke, Matthias Luebbert, Kate Monks; [applications@knauer.net](mailto:applications@knauer.net)  
KNAUER Wissenschaftliche Geräte GmbH, Hegauer Weg 38, 14163 Berlin; [www.knauer.net](http://www.knauer.net)



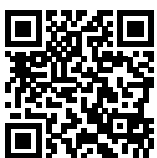
## SUMMARY

A latest approach in bioethanol generation is the usage of yeast and bacteria that uses C5 sugars for fermentation and the valorization of bio refinery by products. Here it is shown that a hemicellulose-like fermentation mash has a high content of the artificial sweetener xylitol and that its purification by HPLC can be accomplished using polymer based Eurokat columns. The product is soluble in water and can easily be used for further applications.

## INTRODUCTION

The second generation of bio refinery uses biomass with lower contents of C6 glucose and higher contents of C5 sugars. Besides ethanol generation its goal is the full usage of biomass by valorizing by products. Fermentation of C5 sugars with microorganisms result in mash that could be used for further applications.

Polymer based Eurokat columns were tested for their ability to separate fermentation mash and among them the Eurokat Ca column had the best separation profile. Analysis of the mash revealed high contents of xylitol. Purification of highly pure xylitol was established.



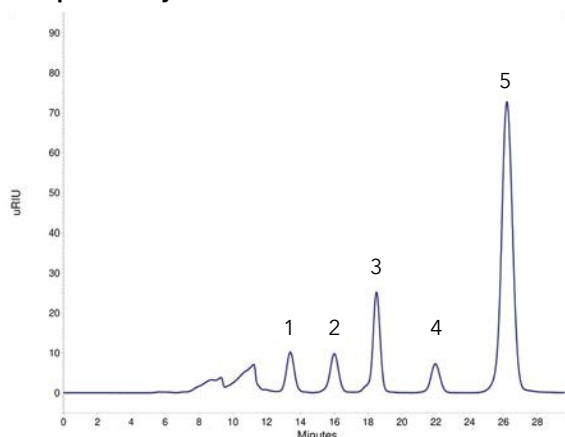
# Alternative xylitol extraction via hplc purification from fermented biomass

## RESULTS

The fermentation mash was analyzed on different columns (Eurokat Na, H, and Ca) to determine the optimal stationary phase. The Eurokat Ca column showed the best separation profile for xylitol **Fig.1** even though it has the longest run with about 28 min compared to Eurokat Na with 18 min and Eurokat H with 12 min (not shown). A more detailed analysis of the fermentation mash identified five components: xylose, arabinose, glycerol, mannitol and xylitol **Fig.1**. Xylitol had the highest concentration with 80 mg/mL in the sample, followed by glycerol with 20 mg/mL.

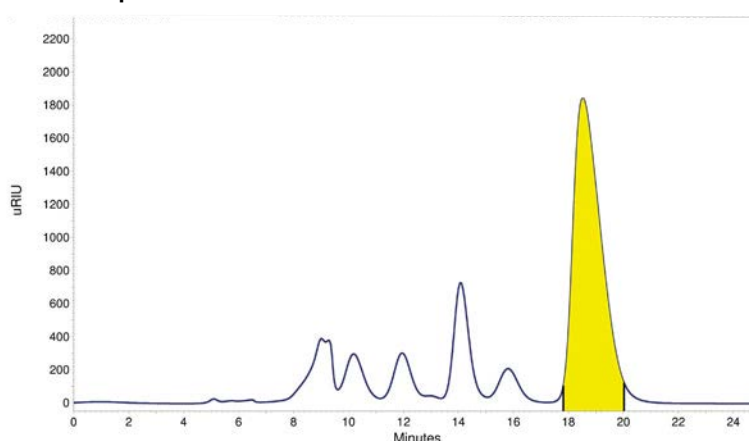
The other three components had concentrations of 7-8 mg/mL **Fig.1**. The baseline separation of xylitol indicated promising batch purification. Overload studies with a semi-preparative Eurokat Ca column were performed. This column has a three times higher volume (50 mL) than the analytical column (15 mL) and larger particle size (25-56  $\mu\text{m}$ ) enabling higher sample loading and faster flow rates with lower back pressure. The collected fraction of xylitol **Fig.2** had a purity of 99 %, measured with RI **Fig.3**.

### Sample analysis



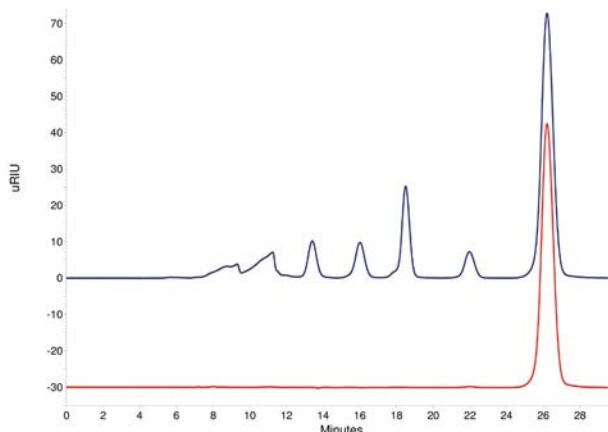
**Fig. 1** Chromatogram of 1:10 dilution of fermentation mash 10  $\mu\text{L}$  injection on Eurokat Ca; 1) xylose (8.2 mg/mL), 2) arabinose (8.3 mg/mL), 3) glycerol (21.0 mg/mL), 4) mannitol (7.0 mg/mL), 5) xylitol (80.6 mg/mL)

### Batch purification



**Fig. 2** Fractionation of xylitol from 1000  $\mu\text{L}$  injection; yellow fraction area (9.5 mL)

### Fraction analysis



**Fig. 3** Comparison of sample and fraction chromatograms; blue - sample, red - fraction from batch purification

**Acknowledgement:** This project has received funding from the European Union's Seventh Framework Program for research, technological development and demonstration under grant agreement no FP7-KBBE-2013-7-613802.



## MATERIALS AND METHOD

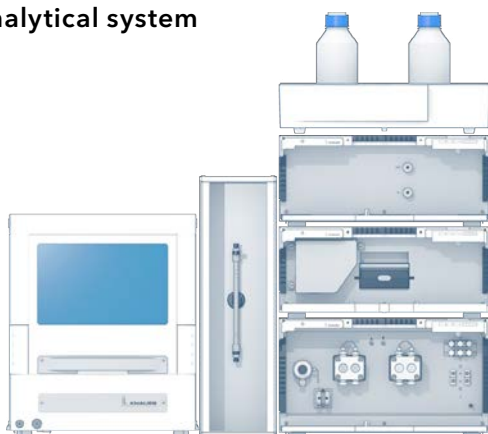
Vogelbusch Biocommodities GmbH provided the fermentation mash that resulted from fermentation with yeasts of hemicellulose-like hydrolysate with high xylose content. The sample was filtered through 0.45  $\mu\text{m}$  filter after centrifugation. A 1:10 dilution was prepared and analyzed. For calibration a mixture of xylose, arabinose, glycerol, mannitol and xylitol was prepared and six dilution steps from 15 mg/mL to 0.3 mg/mL prepared. Analytical runs were performed with KNAUER analytical Eurokat columns (300  $\times$  8 mm) with integrated pre-columns (30  $\times$  8 mm) with 10  $\mu\text{m}$  particles at 75  $^{\circ}\text{C}$  running at flow rates of 0.5 mL/min using H<sub>2</sub>O as eluent. The KNAUER AZURA analytical HPLC system comprising of the AZURA P 6.1L HPG 10 mL pump, 3950 autosampler, AZURA DAD 2.1L diode array detector with high

sensitivity KNAUER LightGuide cartridge flow cell, AZURA RID 2.1L refractive index detector, AZURA CT 2.1 column thermostat controlled by the OpenLAB<sup>®</sup> EZChrom Edition software was used. The purification of xylitol was performed with KNAUER Eurokat Ca columns (250  $\times$  16 mm) with 25–56  $\mu\text{m}$  particles at 75  $^{\circ}\text{C}$  running at flow rates of 2.5 mL/min using H<sub>2</sub>O as eluent. The KNAUER AZURA Preparative HPLC system comprising of the AZURA P 6.1L HPG 50 mL pump, 3950 autosampler (preparative version), AZURA RID 2.1L refractive index detector, AZURA CT 2.1 column thermostat controlled by the OpenLAB<sup>®</sup> EZChrom Edition software was used. The refractive index detector's Extended Dynamic Range (EDR) feature was used for preparative experiments.

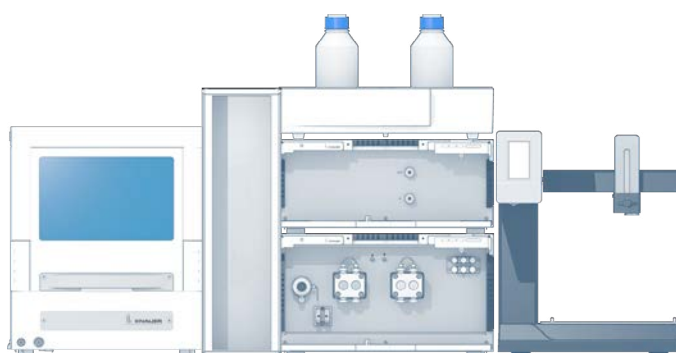
## CONCLUSION

The Eurokat Ca column was found to be the best column for analysis of fermentation mash among tested Eurokat columns. The used fermentation mash has a high content of xylitol (80 mg/mL). A semi-preparative batch purification of the xylitol resulted in high recovery (95 %) of xylitol with a purity of 99 %. Upscaling of the batch process or application of SMB (simulated moving bed) chromatography would be promising for xylitol production from fermentation mash.

AZURA Analytical system



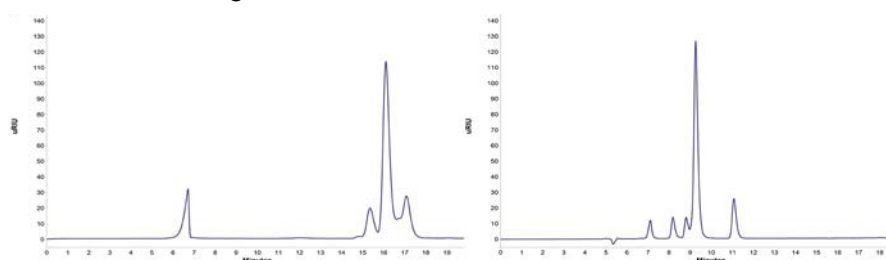
AZURA Preparative system



## ADDITIONAL RESULTS

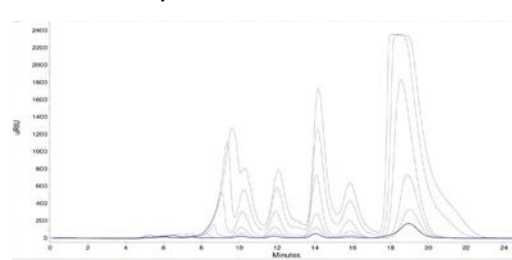
The fermentation mash was separated on Eurokat Na and Eurokat H columns **Fig A1**. On the Eurokat Na column only three peaks were detected. The the Eurokat H column xylitol was also not baseline separated from the other substances. For the overload studies 50 µL to 1500 µL of the 1:10 dilution of the fermentation mash were separated on the Eurokat Ca column. Overlays of all the chromatograms show a shift in the early eluting phase (10-14 min) due to volume overload but less for xylitol **Fig A2**.

### Column screening



**Fig. A1** Chromatograms of 1:10 dilution of fermentation mash; left Eurokat Na; right Eurokat H; 1 xylitol; 10 µL injection

### Overload experiments



**Fig. A2** Overload studies with semi-preparative Eurokat Ca and fermentation mash; 50 µL, 100 µL, 200 µL, 500 µL, 1000 µL, 1500 µL injection

## ADDITIONAL MATERIALS AND METHODS

**Tab. A1** Comparison of properties and method parameters of applied Eurokat columns

Column	Column Dimensions	Particle (µm)	Eluent	Flow rate (mL/min)	Injection Volume(µL)	Temperature (°C)	Column Volume (mL)
Eurokat H	300 × 8 mm + 30 × 8 mm	10	H2O/5 mM H2SO4	0.5	20	75	15
Eurokat Ca, Na	300 × 8 mm + 30 × 8 mm	10	H2O	0.6	20	60	15
Eurokat Ca	250 × 16 mm	25-56	H2O	2.5	10000	75	50

### AZURA Analytical system

Instrument	Description	Article No.
Pump	AZURA P 6.1L, HPG, 10mL, SSt	<a href="#">APH35EA</a>
Autosampler	3950 analytical version	<a href="#">A50070</a>
Detector 1	AZURA DAD 2.1L	<a href="#">ADC01</a>
Flow Cell	High Sensitivity LightGuide 50 mm, 6 µL	<a href="#">AMD59</a>
Detector 2	AZURA RID 2.1L	<a href="#">ADD31</a>
Thermostat	AZURA CT 2.1	<a href="#">A05852</a>
Software	OpenLAB® CDS EZChrom Edition	<a href="#">A2600-1</a>

### AZURA Preparative system

Instrument	Description	Article No.
Pump	AZURA P 6.1L, HPG; 50 ml, SSt	<a href="#">APH38FA</a>
Autosampler	3950 preparative version	<a href="#">A50054-1</a>
Detector	AZURA RID 2.1L	<a href="#">ADD31</a>
Thermostat	AZURA CT 2.1	<a href="#">A05852</a>
Fraction collector	Foxy R1	<a href="#">A59100</a>
Software	OpenLAB® CDS EZChrom Edition	<a href="#">A2600-1</a>

## RELATED KNAUER APPLICATIONS

[VFD0160](#) - Determination of sugars and natural sugar substitutes in different matrices

[VFD0161](#) - Determination of sugars in honey using HILIC separation and RI detection

[VFD0155](#) - Semi preparative xylitol purification with dedicated sugar purification system

[VSP0013](#) - Simplified scale up for sugars with the AZURA RID 2.1L extended dynamic range option

# Determination of aflatoxin M1 in milk

Juliane Böttcher, Kate Monks; applications@knauer.net  
KNAUER Wissenschaftliche Geräte GmbH, Hegauer Weg 38, 14163 Berlin;  
www.knauer.net



## SUMMARY

This application describes a fast and isocratic method for the determination of aflatoxin M1 in milk and raw milk with an easy post column derivatization step using a UVE photochemical reactor. Furthermore, required sample preparation via solid phase extraction (SPE) is recommended.

## INTRODUCTION

Aflatoxins are the best known group of mycotoxins that were named after the main fungi strain producing them as secondary metabolites namely *Aspergillus flavus*. Aflatoxins are also produced by *Aspergillus parasiticus* and to a smaller extent also by other strains. Aflatoxins can accumulate on crops in the field or during storage of agricultural products, especially under warm and humid conditions. Unfortunately, these substances can persist long after the fungi have

been killed and therewith contaminate foods. The more common aflatoxins, which include G2, G1, B2, and B1, have been identified as contaminants in cattle feed. Upon ingestion, aflatoxins B2 and B1 are metabolized to M2 and M1, potentially adulterating dairy products. The maximum aflatoxin M1 level set by the U.S. Food and Drug Administration and European Commission is 0.5 µg/L. [1,2].

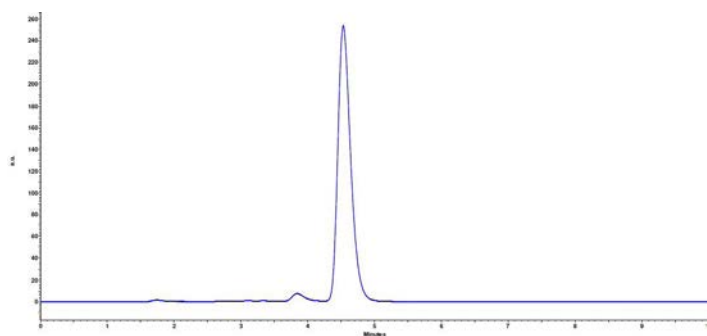


# Determination of aflatoxin M1 in milk

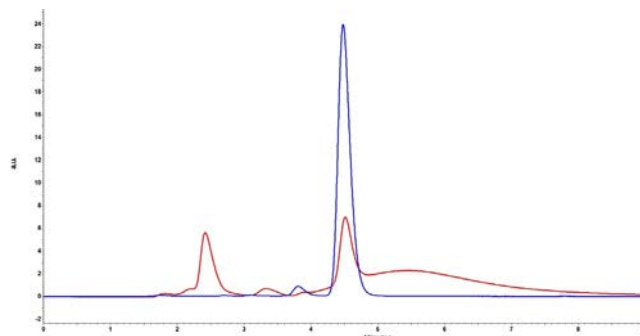
## RESULTS

First, the analytical method was developed using a standard solution. **Fig 1** shows the fluorescence chromatogram with post column derivatization using the UVE photochemical reactor for an aflatoxin M1 standard at a concentration of 1  $\mu\text{g}/\text{mL}$ . To make sure that the legal limit value is detectable, a milk sample was spiked with aflatoxin M1 to a concentration of 0.5  $\mu\text{g}/\text{L}$  and pretreated with online solid phase extraction. **Fig 2** shows an overlay of the spiked milk sample after sample preparation and the aflatoxin M1 standard. Although matrix effects occur through SPE pretreatment it was possible to quantify aflatoxin M1 in the

measured milk sample spiked down to 0.5  $\mu\text{g}/\text{L}$ . For sample pretreatment following SPE procedure was conducted [4]: 20 mL of the spiked milk were diluted with 30 mL distilled water. A CHROMABOND® C18 ec SPE column was conditioned with 10 mL methanol and subsequently with 10 mL water. After this the sample was slowly forced or aspirated through the column. The SPE column was washed with 10 mL water and 10 mL n-hexane. Afterwards the column was dried for 10-20 min at 50°C or overnight at ambient temperature. After drying the sample was eluted with 3 mL acetonitrile.



**Fig. 1** Chromatogram aflatoxin M1 standard 1  $\mu\text{g}/\text{mL}$



**Fig. 2** Overlay of spiked milk sample after SPE (red) and standard (blue)

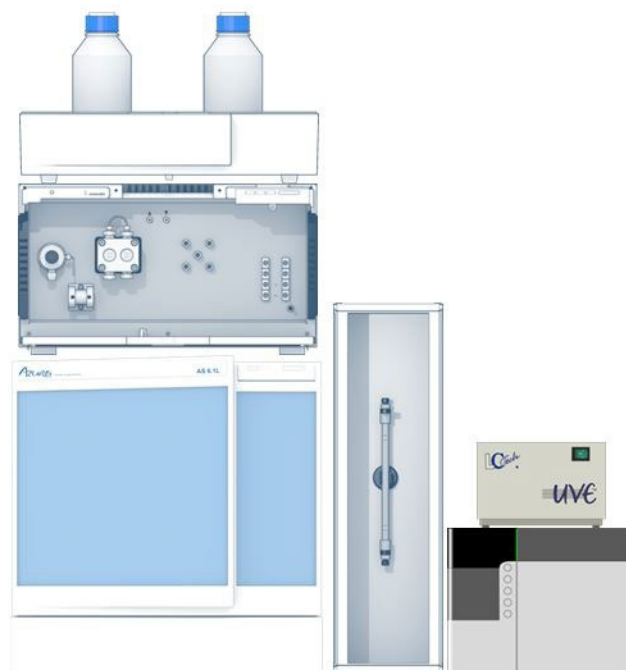
## MATERIALS AND METHODS

An AZURA Analytical HPLC Plus system was used for this application. It consisted of an AZURA P 6.1L LPG pump, an autosampler 3950, an AZURA CT 2.1 column thermostat, the UVE photochemical reactor and fluorescence detector RF-20Axs. The analytical method was run isocratically at a flow rate of 0.8 mL/min

with a mixture of water, methanol and acetonitrile 60:25:15 (v/v). The column thermostat was set to 30 °C and the detector was set to excitation 365 nm/emission 455 nm. The sensitivity was adjusted to high with a gain of 16. The used column was filled with KNAUER Eurospher II 100-3 C18 silica.

## CONCLUSION

Using the UVE photochemical reactor for post column derivatization in combination with the AZURA Analytical HPLC system and fluorescence detection, the valid maximum limit values of 0.5 µg/L for aflatoxin M1 in milk and other dairy products could be quantified.



## REFERENCES

- [1] FDA Mycotoxin Regulatory Guidance, National Grain and Feed Association 1250 Eye St., N.W., Suite 1003, Washington, D.C., 20005-3922 August 2011, <http://www.ngfa.org/wp-content/uploads/NGFAComplianceGuide-FDARegulatoryGuidance-forMycotoxins8-2011.pdf>
- [2] COMMISSION REGULATION (EC) No 1881/2006 of 19 December 2006 setting maximum levels for certain contaminants in foodstuffs, Official Journal of the European Union, L 364/5 - L 364/24, 20.12.2006, <http://eur-lex.europa.eu/legal-content/EN/TXT/PDF/?uri=CELEX:32006R1881&qid=1487915647230&from=EN>
- [3] <http://www.mn-net.com/DesktopModules/TabID/10160/default.aspx>

## ADDITIONAL RESULTS

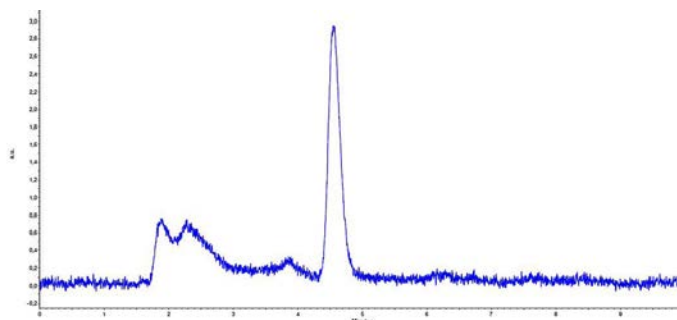


Fig.A1 Chromatogram aflatoxin M1 standard 0.001 µg/mL

## ADDITIONAL MATERIALS AND METHODS

Tab.A1 Method parameters

Eluent A	Water/Methanol/Acetonitrile 60:25:15		
Gradient	Isocratic 100 % A		
Flow rate	0.8 mL/min	System pressure	260 bar
Column temperature	30 °C	Run time	10 min
Injection volume	10 µL	Injection mode	Full loop
Detection wavelength	Ex 365 nm/Em 455 nm	Data rate	5 Hz
		Time constant	0.2 s



Tab.A2 System configuration

Instrument	Description	Article No.
Pump	AZURA P 6.1L, LPG 10mL, SSt	<a href="#">APH34EA</a>
Autosampler	3950 analytical version	<a href="#">A50070</a>
Detector	RF-20Axs	<a href="#">A59201</a>
Thermostat	AZURA CT 2.1	<a href="#">A05852</a>
Software	OpenLAB CDS EZChrom Edition	<a href="#">A2600-1</a>
Column	Vertex Plus Column, 150x3 mm ID with precolumn, Eurospher II 100-3 C18	<a href="#">15XE181E2G</a>
Post column derivatisation	UVE photochemical reactor	<a href="#">A07547</a>

## RELATED KNAUER APPLICATIONS

[VFD0146](#) - Sensitive online SPE determination of Bisphenol A in water samples

[VFD0159](#) - Alternaria alternata - determination of main metabolites

[VFD0158](#) - Zearalenone and its major metabolites - a simple isocratic method



# GPC cleanup of olive oil samples

Michaela Schulze, Kate Monks; applications@knauer.net

KNAUER Wissenschaftliche Geräte GmbH, Hegauer Weg 38, 14163 Berlin; www.knauer.net



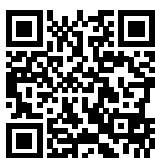
## SUMMARY

This work describes a sample cleaning method for analyzing pesticide residues in olive oil in preparation for an HPLC analysis. Pesticides were separated from the oil matrix by size exclusion/gel permeation chromatography (GPC) according to US EPA SW-846 method 3640A. The GPC material used in this study was BioBeads SX-3 and the GPC solvent system was cyclohexane/ethyl acetate (1:1, v/v). The optimized GPC purification technique was carried out with a KNAUER AZURA® GPC Cleanup System for automated sample cleaning.

## INTRODUCTION

GPC is extensively used as an effective post-extraction cleanup procedure for removing high molecular weight interferences such as lipids, proteins, and polymers from sample extracts. The efficiency of BioBeads SX-3 with an organic solvent to separate multi-pesticide residues has been extensively documented [1-3].

The GPC technique is appropriate for both polar and non-polar analytes so it can be effectively used to cleanup extracts containing a broad range of compounds. To demonstrate the flexibility of the sample cleaning method, the olive oil samples investigated were spiked with different types of compounds.

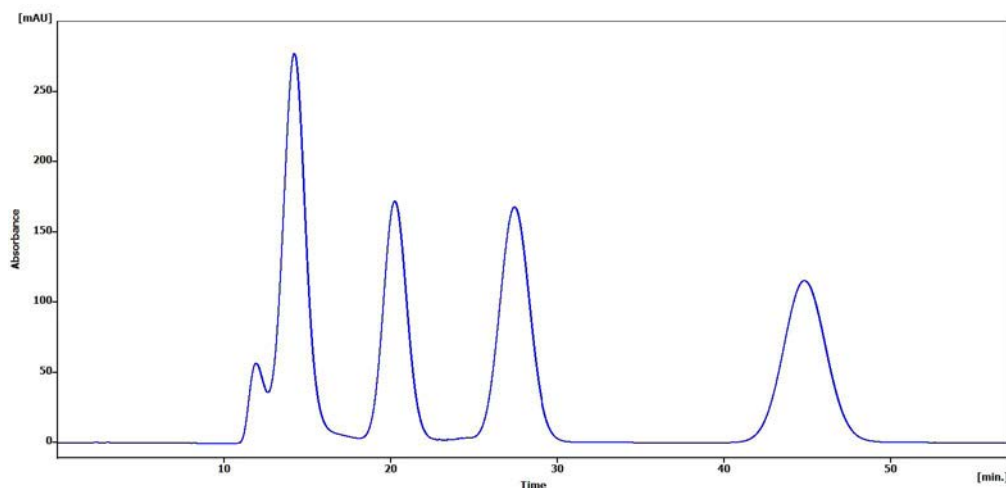


# GPC cleanup of olive oil samples

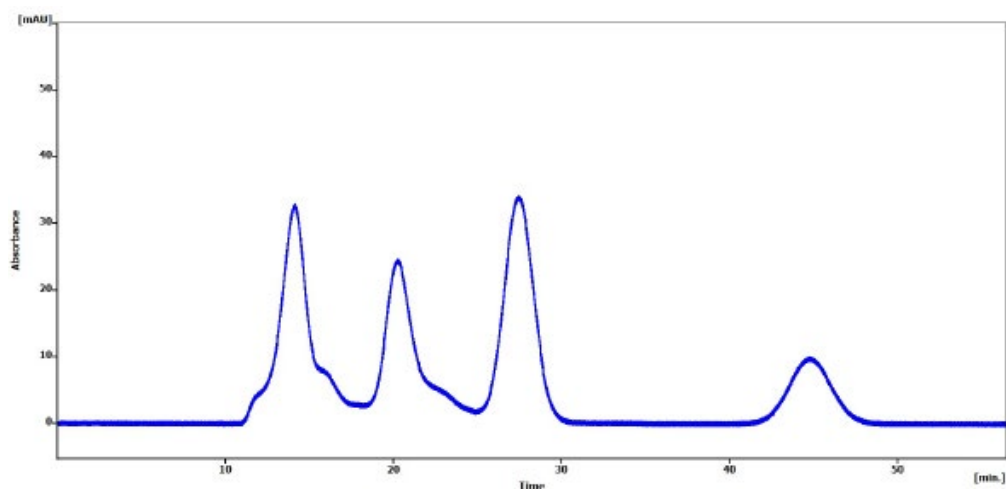
## RESULTS

**Fig 1** shows the chromatogram of the GPC calibration standard eluted with cyclohexane/ethyl acetate (1:1, v/v). The three detected pesticides were baseline separated and could be identified easily. **Fig 2** shows the elution profile of one olive oil sample containing different types of pesticides. It can be seen that all pesticides were detected with the US EPA method

3640A. Compared to the measurement of the standard solution, the spiked sample showed less matrix effects. This means that all interfering high molecular elements were removed during clean up. The recovery for all of these compound classes was higher than 70 %.



**Fig. 1** Chromatogram of US EPA method 3640A calibration standard containing  
1) Corn oil matrix, 2) Bis-(2-ethylhexyl)phthalate, 3) Methoxychlor, 4) Perylene



**Fig. 2** Chromatogram of olive oil sample, spiked with pesticides:  
1) Olive oil matrix, 2) Bis-(2-ethylhexyl)phthalate, 3) Methoxychlor, 4) Perylene

## MATERIALS AND METHODS

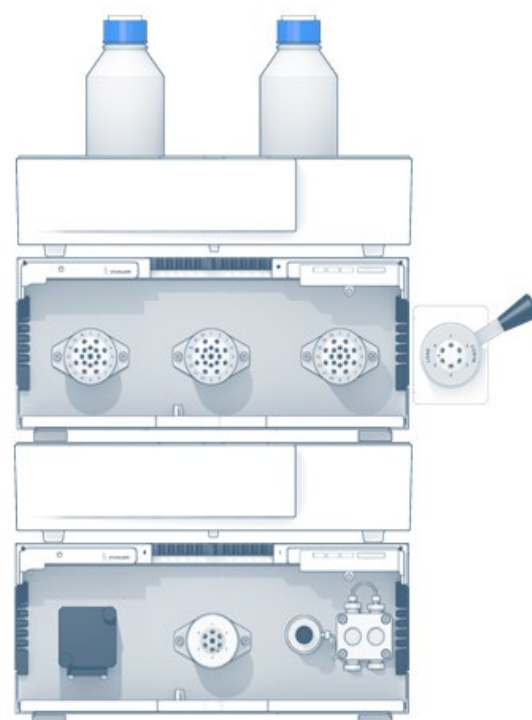
This study used the KNAUER AZURA GPC Cleanup System which automates the GPC cleanup process. The system comprising of the two AZURA ASM 2.1L Assistant modules with different valves, a pump, and a UV detector. The compounds were detected at 254 nm wavelength with the AZURA UVD 2.1S UV detector with 10 Hz data rate. The two 16-port multiposition valves used here enabled the loading of up to 15 oil samples (1 mL or 5 mL samples loops). Moreover, the pesticide fraction was collected in a round-bottomed flask between the elution of corn oil by a third 16-port multiposition valve. The glass column with BioBeads SX-3 was flushed with cyclohexane/ethyl acetate (1:1, v/v) for an extended period at a flow rate of 5 mL/min. To determine the elution profile of the GPC column, a calibration solution was prepared in cyclohexane/ethyl acetate containing the following analytes: corn oil (25 g/L), bis(2-ethylhexyl) phthalate (1 g/L), methoxychlor (0.2 g/L), and perylene (0.02 g/L). The calibration solution was injected after solvent flow and column pressure were established. The eluates were collected based on the UV traces of the four eluates. For further analysis purposes with GC, DC or HPLC techniques (not described here), the various oil sample fractions collected were carefully evaporated under a nitrogen stream, dispensed in 1 mL of a suitable solvent and filtered using a 0.45  $\mu\text{m}$  syringe filter.

## REFERENCES

- [1] Chamberlain, S.J. Determination of multi-residues in cereal products and animal feed using gel-permeation chromatography. *Analyst* (1990), 115:1161-1165
- [2] Di Muccio, A.; Ausili, a.; Versori, L; Camoni, I; Dommarco, t; Ganibetti, L; santillo, A and Versori, F. Single-step multi-residue clean-up for organophosphate pesticide residue determination in vegetable oil extracts by gas chromatography. *Analyst* (1990), 115: 1167-1169
- [3] Guardia-Rubio, M; Fernandez-De Cordova, M.L.; Ayory-Canada, M.J. and Ruiz-Medina, A. Simplified pesticide multi-residue analysis in virgin olive oil by gas chromatography with thermoionic specific, electron-capture and mass spectrometric detection. *J. of Chrom. A* (2006) Volume 1108, 231-239

## CONCLUSION

GPC sample preparation is a useful tool for separating small amounts of pesticides from high molecular weight matrices such as olive oil. The KNAUER AZURA® GPC Cleanup System is particularly well-suited for sample preparation in pesticide analysis but can also be easily adapted to other laboratory procedures to perform a large variety of GPC sample preparation tasks. The arrangement of the 15 sample loops and one wash loop avoids cross contamination hence allowing a robust sample preparation procedure.



## ADDITIONAL MATERIALS AND METHODS

**Tab. A1** Sample preparation

StandardsQ	Prepared and diluted with Cyclohexane/ethyl acetate (1:1, v/v)
1. Corn oil	25 g/L
2. Bis-(2-ethylhexyl)phtalate	1 g/L
3. Methoxychlor	0.2 g/L
4. Perylene	0.02 g/L

**Tab. A2** Method parameters

Eluent A	Cyclohexane/ethyl acetate (1:1, v/v)		
Isocratic	Time [min]	% A	% B
	0	100	0
	60	100	0
Flow rate	5 mL/min	System pressure	0.6 bar
Column temperature	25°C	Run time	60 min
Injection volume	1 mL	Injection mode	Full loop
Detection wavelength	254 nm	Data rate	10 Hz
		Time constant	0.1 s

**Tab. A3** System configuration

Instrument	Description	Article No.
Assistant 1	AZURA ASM 2.1L, <b>left:</b> single variable wavelength UV detector <b>middle:</b> 6 port 2 position injection valve, 1/16" connectors <b>right:</b> Pump with pressure sensor, 10 mL pump head, SSt	<a href="#">AYCAEABA</a>
Assistant 2	AZURA ASM 2.1L, <b>left:</b> 16 port multi position valve, 1/16" connectors <b>middle:</b> 16 port multi position valve, 1/16" connectors <b>right:</b> 16 port multi position valve, 1/16" connectors	<a href="#">AYGAGAGA</a>
Flow cell	UV, 3mm, 2 µL	<a href="#">A4042</a>
GPC tubing guide	16 sample loops with 1 ml	<a href="#">A5329-2</a>
Software	ClarityChrom	<a href="#">A1670-9</a>
Column	BioBeads SX-3	<a href="#">B41</a>
Injection valve	Manual injection valve 6-Port/2-position, 1/16" connectors	<a href="#">AVI26BC</a>



**Dedicated AZURA® GPC Cleanup System**

## RELATED KNAUER APPLICATIONS

[VEV0081](#) - GPC vs. SPE and subsequent determination of polycyclic aromatic hydrocarbons using GC/MS

[VEV0082](#) - GPC cleanup method for soil samples before PAHs analysis

[VFD0166](#) - LC-FLD analysis of 4 PAHs in olive oil samples using AZURA® GPC Clean-up System

# Semi preparative xylitol purification with dedicated sugar purification system

Yannick Krauke, Matthias Lübbert, Kate Monks; [applications@knauer.net](mailto:applications@knauer.net)  
KNAUER Wissenschaftliche Geräte GmbH, Hegauer Weg 38, 14163 Berlin; [www.knauer.net](http://www.knauer.net)



## SUMMARY

Xylitol is used as sweetener in the food industry and is generated by chemical conversion of xylose. Here, xylitol was purified from fermentation mash by microbial xylose conversion. The AZURA® Sugar purification system with the AZURA RID 2.1L refractive index detector was used for this semi - preparative purification in combination with polymer-based Eurokat Ca column.

## INTRODUCTION

The second generation of bio refinery is using biomass with low contents of C6 sugars such as wheat straw. This biomass is often rich in the C5 sugar xylose which is normally not used as a carbon source by microorganisms for ethanol production. Xylose is chemically converted to xylitol which is a five-carbon sugar alcohol occurring in nature mostly in low concentrations and its extraction is too unproductive. It has found its application i.e. food industry as an artificial sweetener in chewing gums. It has been shown that xylose can be converted to xylitol by different yeast and bacteria

species [1, 2]. The microbial conversion of xylose to xylitol, followed by a simple purification process, presents an economical and environmentally-friendly alternative [3]. A previous study already revealed the feasibility of semi-preparative xylitol purification from fermentation mash (VFD0150). In this study, method optimization for xylitol purification was performed with the same stationary phase material. The AZURA RID 2.1L detector could be used for this task due to its ability to sustain flow rates up to 10 mL/min and 5 bar back pressure.

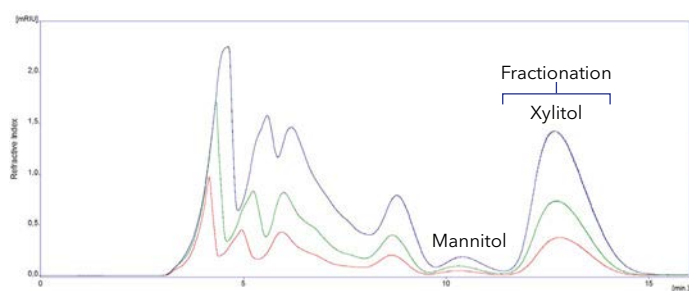


# Semi preparative xylitol purification with dedicated sugar purification system

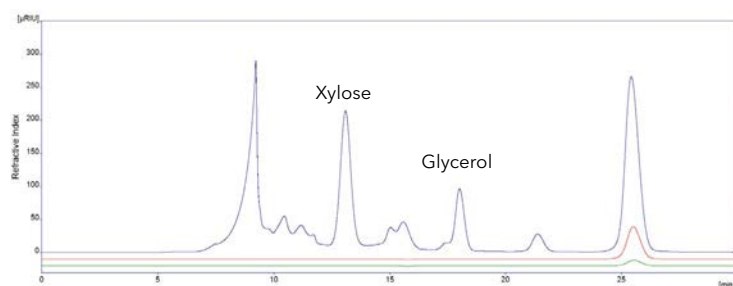
## RESULTS

The separation profile of the semi-preparative Eurokat Ca 150 × 20 mm column was tested by injection of 0.5 mL fermentation mash (FM; 1:2 dilution). Overlay of the resulting chromatogram with chromatograms of standard solution and retention time comparison identified xylitol, mannitol, glycerol and xylose in the sample (see add. results Fig. A1). Also at larger injection volumes (1 mL, 2 mL) xylitol could still be baseline separated from mannitol (Fig. 1). Due to the shorter column length (150 × 20 mm) and faster flow rate (4 mL/min) the xylitol peak eluted earlier (approx. 13 min) compared to previous study where it eluted

at 19 min using a longer column (250 × 16 mm) and lower flow rate (2.5 mL/min) (VFD0150). After injection of 2 mL FM a 12 mL fraction of xylitol was recovered (Fig. 1, blue bracket). The analysis of the 12 mL xylitol fraction and subsequent comparison with chromatograms of a xylitol standard (1 mg/mL) and FM revealed no contaminations in the xylitol fraction (Fig. 2, red line). Measurements of xylitol concentration in the FM showed an initial concentration of approx. 60 mg/mL xylitol and a concentration of approx. 5.6 mg/mL xylitol in the fraction, revealing an about 11 fold dilution of xylitol by batch purification.



**Fig. 1** Chromatogram overlay of different injection volumes from fermentation mash (1:2 dilution); red - 0.5 mL, green - 1 mL, blue - 2 mL; blue brackets-fractionation area 2 mL injection; EK Ca 150 x 20 mm; 4 mL/min; 60 °C



**Fig. 2** Overlay of analytical chromatograms; blue - fermentation mash (1:2 dilution); red - fractionation sample from Fig. 1; green - xylitol standard 1 mg/mL; 10 µl each; EK Ca 300 x 8 mm; 75 °C

**Acknowledgement:** This project has received funding from the European Union's Seventh Framework Program for research, technological development and demonstration under grant agreement no FP7-KBBE-2013-7-613802.



## MATERIALS AND METHOD

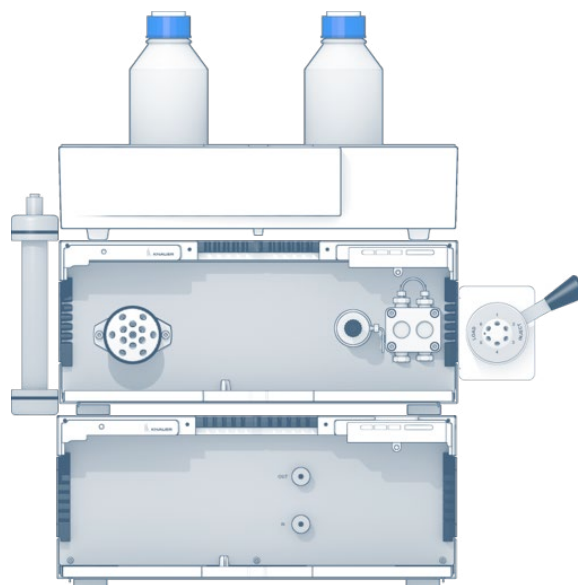
The AZURA sugar purification system consists of an assistant AZURA ASM 2.1L with a 12 port multi position valve (for fractionation) and 50 mL pump and an AZURA RID 2.1L refractive index detector. Eurokat Ca 150 × 20 mm column (sulfonated cross-linked styrene-divinylbenzene copolymer) with 25–56 µm particles was used for purification. The column was heated with a heating jacket to 60 °C. Purification run was in isocratic mode for 16 min at 4 mL/min. Different injection volumes were tested. The data rate was set to 5 Hz, time constant 0.02 sec.

## CONCLUSION

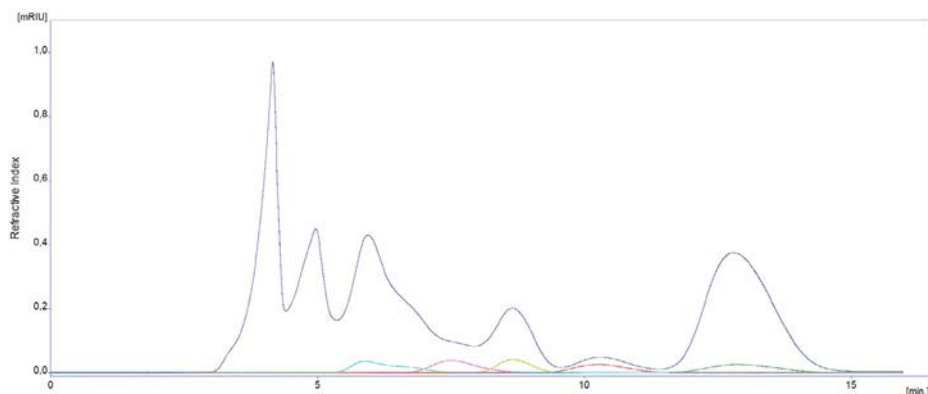
Two main results were achieved with this study: 1. Optimization of the batch xylitol purification process and 2. Application of the AZURA RID 2.1L refractive index detector for semi-preparative sugar purification at higher flow rates. Xylitol was purified with a purity of >99 % and recovery of >99 % from fermentation mash of microbial xylose to xylitol conversion. Elution time (13 min) and temperature (60 °C) was reduced and injection volume (2 mL) increased when compared to early study ([VFD0150](#)).

## REFERENCES

- [1] Tamburini E.; Costa S., Gabriella Marchetti M., Pedrini P. *Biomolecules* 5: 1979–1989 (2015)
- [2] Hernandez-Perez A.F., Vaz de Arruda p., Gracias de Almeida Felipe M.d.FTI 20037. *Brazilian Journal of microbiology* 47: 489-496 (2016)
- [3] Chen X., Jian Z.-H., Chen S., Qin W. *Int. J. Biol. Sci.* 6(7): 834–844 (2010)



## ADDITIONAL RESULTS



**Fig. A1** Chromatograms of 0.5 mL injection of fermentation mash (1:2 dilution) and standards (2 mg/mL each); blue - FM; EK Ca 150 x 20 mm; 60 °C; 4 mL/min

## ADDITIONAL MATERIALS AND METHODS

**Tab. A1** Method parameters (preparative purification)

Eluent A	H <sub>2</sub> O <sub>dd</sub>		
Gradient	isocratic, 100 % A		
Flow rate	4 mL/min	System pressure	5.5 bar
Column temperature	60 °C	Run time	16 min
Injection volume	0.5 mL, 1 mL, 2 mL	Injection mode	Full loop
Detection wavelength	RI	Data rate	5 Hz
		Time constant	0.02 sec

**Tab. A2** Method parameters (fraction analysis)

Eluent A	H <sub>2</sub> O <sub>dd</sub>		
Gradient	isocratic, 100 % A		
Flow rate	0.5 mL/min	System pressure	24 bar
Column temperature	75 °C	Run time	30 min
Injection volume	20 µL	Injection mode	Full loop
Detection wavelength	RI	Data rate	5 Hz
		Time constant	0.05 sec

**Tab. A3** System configuration

Dedicated Sugar purification system			Dedicated System Sugar Analytic		
Instrument	Description	Article No.	Instrument	Description	Article No.
Detector	AZURA RID 2.1L	<a href="#">ADD31</a>	Detector	AZURA RID 2.1L	<a href="#">ADD31</a>
Injection	Manual 6-port/3-channel injection valve	<a href="#">A1357</a>	Injection	Manual 6-port/3-channel injection valve	<a href="#">AVI26BC</a>
Assistant	AZURA ASM 2.1L: Left: 12 port Multiposition valve as fractionation valve, 8" Middle: - Right: AZURA P 4.1S, 50 mL SSt	<a href="#">AYFALXBD</a>	Pump	AZURA P 6.1L, isocratic, 10 ml, SSt	<a href="#">APH30EA</a>
Thermostat	Customized heating sleeve, 150 x 20 mm Temperature Control for KNAUER Column Heating Sleeve	<a href="#">A57026</a> <a href="#">A57024</a>	Thermostat	AZURA CT 2.1	<a href="#">A05852</a>
Column	Eurokat Ca 150 x 20 mm	<a href="#">15PX360EKX</a>	Column	Vertex Plus Column 300 x 8 mm Eurokat H, 10 µm	<a href="#">30GX340EKN</a>
Software	ClarityChrom® Prep 6.1.0	<a href="#">A1685-9</a>	Software	ClarityChrom 6.1.0	<a href="#">A1670-9</a>

## RELATED KNAUER APPLICATIONS

[VFD0160](#) - Determination of sugars and natural sugar substitutes in different matrices

[VFD0161](#) - Determination of sugars in honey using HILIC separation and RI detection

[VSP0013](#) - Simplified scale up for sugars with the AZURA RID 2.1L extended dynamic range option

[VFD0150](#) - Alternative xylitol extraction via hplc purification from fermented biomass



# Determination of osmolality of isotonic and non-isotonic beverages

Juliane Böttcher, Till Myrach, Kate Monks; applications@knauer.net  
KNAUER Wissenschaftliche Geräte GmbH, Hegauer Weg 38, 14163 Berlin;  
www.knauer.net



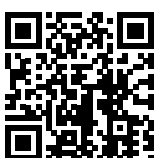
## SUMMARY

In the last years isotonic beverages have become more and more popular. Almost every drink is available in an isotonic version. But what does isotonic mean and what are its benefits? How can be checked that beverages are really isotonic? And have you ever heard of osmolality?

## INTRODUCTION

Every liquid containing substances such as minerals, carbohydrates, or proteins has an osmotic pressure. Isotonic or iso-osmotic means that the liquid has the same osmotic pressure as human blood. This feature allows an accelerated ingestion of salt and sugars from the drink which results in a faster recovery after sporting activity. A fast and easy way to check how many osmotically active molecules are solved in a

liquid is to determine its osmolality. The osmolality is a general measure for the number of molecules and is commonly given in mOsmol/kg solvent. An isotonic drink **Fig 1** is defined to have an osmolality of  $300 \pm 10\%$  mOsmol/kg. These limit values are for example fixed by the European Food Safety Authority, short EFSA [1].



# Determination of osmolality of isotonic and non-isotonic beverages

## RESULTS

Six different samples of isotonic and non-isotonic drinks were measured, the osmolality was determined using the K-7400S osmometer which correlates freezing point depression with osmolality. The osmometer was calibrated in a range of 0-850 mOsmol/kg for isotonic samples and in a range from 0-2000 mOsmol/kg for non-isotonic drinks, respectively. Ten replicates were measured for each sample using a sample volume

of 150  $\mu$ L. The diagram in Fig 2 shows the average values of osmolality for the isotonic samples together with the EFSA limits. The non-isotonic beverages have a much higher osmolality. For samples of caffeine containing soft drink and beer osmolalities of 644 mOsmol/kg and 1008 mOsmol/kg, respectively, were determined. As alcohol is also depressing the freezing point, the osmolality



Fig. 1 Isotonic beverages

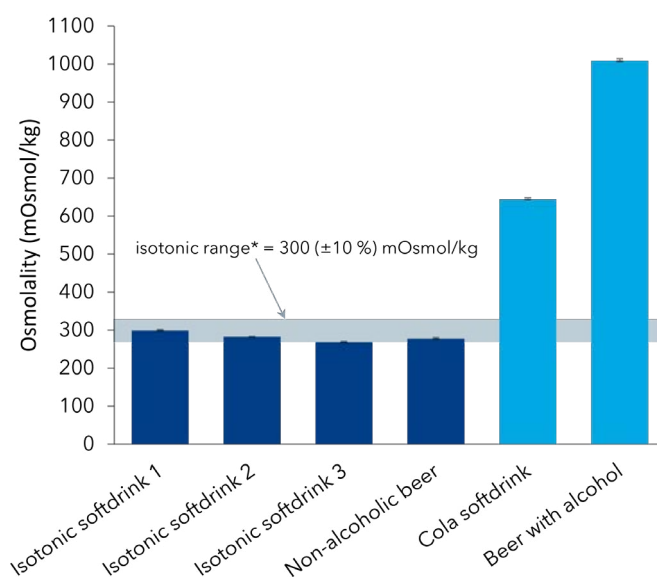


Fig. 2 Measured osmolalities of four different as isotonic declared as well as two non-isotonic beverages. Graph shows average values and standard deviations of 10 replicates

## MATERIALS AND METHOD

All measurements were made with the KNAUER K-7400S Semi-Micro Osmometer. The used calibration standards had osmolality values of 300, 850 and 2000 mOsmol/kg. The system parameters were set to  $-8\text{ }^{\circ}\text{C}$  for freeze and  $-16\text{ }^{\circ}\text{C}$  for cooling limit. The samples of soft drinks and beer were degassed using an ultrasonic bath to remove the carbon dioxide. Then  $150\text{ }\mu\text{L}$  of the samples were transferred to a plastic sample tube.

## CONCLUSION

The osmolalities of all analyzed isotonic samples were within the EFSA defined range. In general, the values were below  $300\text{ mOsmol/kg}$ , which could be due to the sample preparation (degassing) and a subsequent reduction of carbon dioxide. Due a higher content of solved compounds like sugars or alcohol, in the case of beer, non-isotonic beverages showed significantly higher osmolalities.

## REFERENCES

[1] Scientific Opinion on the substantiation of health claims related to carbohydrate-electrolyte solutions and reduction in rated perceived exertion/effort during exercise (ID 460, 466, 467, 468), enhancement of water absorption during exercise (ID 314, 315, 316, 317, 319, 322, 325, 332, 408, 465, 473, 1168, 1574, 1593, 1618, 4302, 4309), and maintenance of endurance performance (ID 466, 469) pursuant to Article 13(1) of Regulation (EC) No 1924/2006 EFSA Panel on Dietetic Products, Nutrition and Allergies (NDA); <http://onlinelibrary.wiley.com/doi/10.2903/j.efsa.2011.2211/pdf>



## ADDITIONAL RESULTS

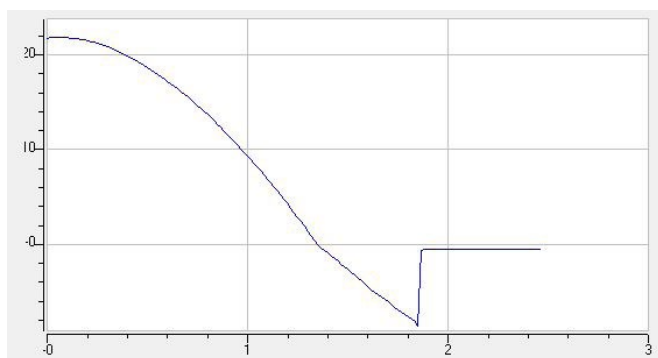


Fig.A1 Temperature-time-curve

Tab.A1 Average osmolalities of isotonic and non-isotonic beverages

Beverage	Isotonic softdrink 1	Isotonic softdrink 2	Isotonic softdrink 3	Non-alcoholic beer	Cola softdrink	Beer with alcohol
Average Osmolality (n=10)	300	284	270	278	644	1009
$\sigma$	2.7	0.7	1.6	3.2	3.8	5.7

## ADDITIONAL MATERIALS AND METHODS

Tab.A2 Method parameters

Calibration 1	0 mOsmol/kg	300 mOsmol/kg	850 mOsmol/kg
Calibration 2	0 mOsmol/kg	850 mOsmol/kg	2000 mOsmol/kg
Sample volume	150 $\mu$ L		
Freeze	-8 °C		
Cooling limit	-16 °C		

Tab.A3 System configuration

Instrument	Description	Article No.
Osmometer	KNAUER K-7400S Semi-Micro Osmometer	<a href="#">A0006AC</a>
Sample tubes	Approved plastic sample tubes, 500 pcs.	<a href="#">A0272</a>
Software	EuroOsmo 7400	<a href="#">A3705</a>

## RELATED KNAUER APPLICATIONS

[VPH0064](#) - Quality control of pharmaceutical solutions by determination of osmolality

# Simulated Moving Bed (SMB) - a powerful tool for continuous purification of xylitol



Yannick Krauke, Christian Benkhäuser, Matthias Lübbert, Kate Monks; [applications@knauer.net](mailto:applications@knauer.net)  
KNAUER Wissenschaftliche Geräte GmbH, Hegauer Weg 38, 14163 Berlin; [www.knauer.net](http://www.knauer.net)

## SUMMARY

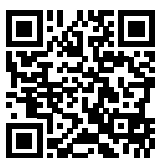
Simulated moving bed chromatography (SMBC) was applied for the purification of xylitol from fermentation mash of a fed batch culture. This process enabled to purify xylitol with nearly 100 % purity and recovery. Thus, allowing large scale purification of xylitol from biological xylose-xylitol conversion process.

## INTRODUCTION

Within the European Valor Plus research project an alternative, biological way of xylose conversion was investigated. By using a *Candida* yeast strain, xylose from a hemicellulose hydrolysate was converted to xylitol. HPLC analysis of the fermentation mash revealed that the xylose to xylitol conversion was successful. Previous batch HPLC experiments (App. note VFD0155) indicated the potential to apply SMBC for this purification task. The separation was performed in isocratic mode on polymer based Eurokat

columns and the target substance xylitol eluted at the end of the chromatogram, all factors enabling a SMB process.

SMB chromatography is a continuous chromatography technique that separates binary or pseudo-binary mixtures into pure substances or fractions. Compared to traditional batch chromatography this process leads to higher yields of purified substances while consuming less eluent and packing material.



# Simulated Moving Bed (SMB) – a powerful tool for continuous purification of xylitol

## RESULTS

For the set-up of a SMB process several parameters of the separation process had to be determined. First, separation at three different temperatures (40°C, 50°C, 60°C) was tested. Separation at 50°C gave the favourable results and was therefore chosen for the purification. Overload studies with a 1:2 dilution of the fermentation mash revealed a nearly baseline separation of xylitol and mannitol. The chromatogram was divided in the raffinate fraction (all but xylitol) and the extract fraction (xylitol) (Fig 1). A substance eluting with the dead time of the system was determined and therefore an open-loop set-up was chosen with a waste outlet. The retention times of the substances and column porosity were determined and used for the process set-up. Using these values and the PurityChrom® MCC software the flow rates of the pumps and different zones in the process were obtained (Fig 2). After six cycles, samples from the extract, raffinate and waste were collected and analyzed. A fast analytical method (add. results Fig A1) enabled a rapid evaluation of the process. A more detailed

analysis revealed pure xylitol in the extract without any mannitol in the raffinate or waste (Fig 3 blue/green lines). With this SMB process 1.8 g/h xylitol were purified with 100% purity and recovery. The yield of the SMB process is greater by the factor of seven than that of the batch process.

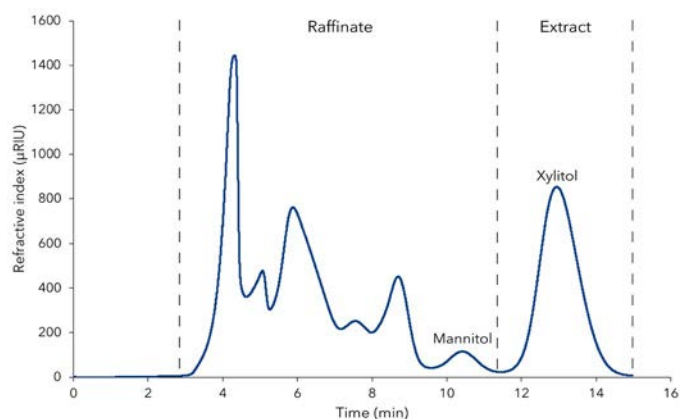


Fig. 1 Design of SMB process on chromatogram of fermentation mash with indication of the two fractions "raffinate" and "extract"; 1 mL injection; Eurokat Ca 150 x 20 mm, 25 -56 µm particles; 4 mL/min; 50°C

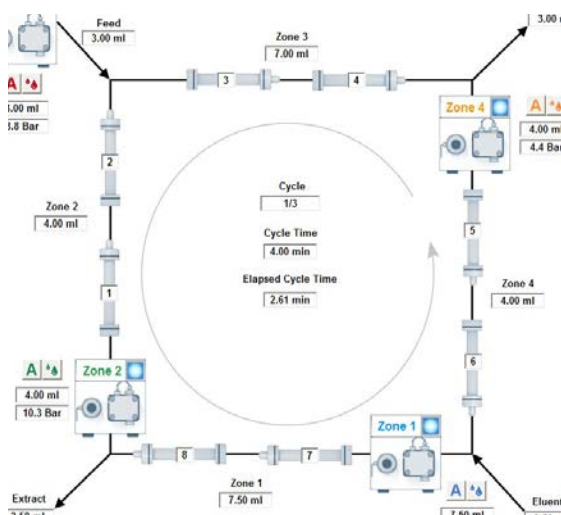


Fig. 2 Example scheme of the SMB process set-up with the four pumps, the out - and inlets, the 8 columns, four zones, indication of flow rates, pressure and cycle time; PurityChrom MCC software

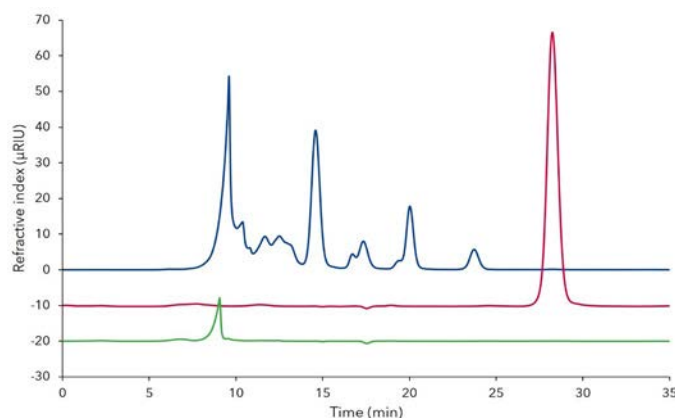


Fig. 3 Overlay of analytical chromatograms of raffinate/all but xylitol (blue), extract/xylitol (red) and waste (green) from the SMB process at the 6th cycle; 20 µL injection; Eurokat Ca 300 x 8 mm + pre-column; 10 µm particles, 0.5 mL/min; 75°C

## MATERIALS AND METHOD

The SMB standard configuration consists of four AZURA® Assistans ASM 2.1L with seven multiposition valves and four P 4.1S Pumps (10/50 mL/min). Flow was controlled with two CORI-Flow M13 flow meters and temperature with the SMB oven. Eight identical Eurokat Ca 150 x 20 mm columns (sulfonated cross-linked styrene-divinylbenzene copolymer) with 25-56µm particles were used for purification. Analysis was performed with Eurokat Ca columns 300 x 8 mm, 10 µm particles and dedicated analytical sugar system (VFD0151).

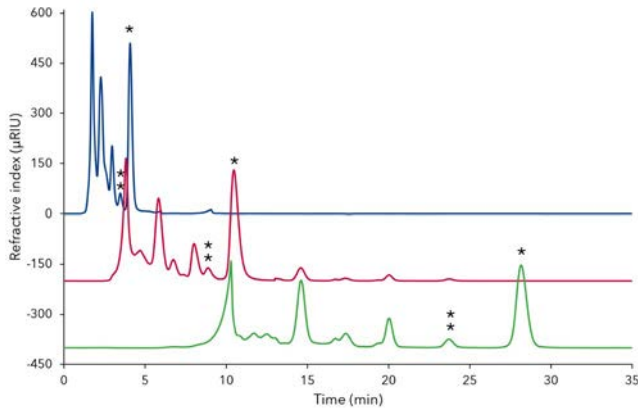
## CONCLUSION

Xylitol was purified with high purity and yield from fermentation mash using the AZURA® SMB system. This purification process allows a significant higher throughput and thus yield of xylitol as classical batch chromatography. The actual throughput is limited by the concentration of xylitol in the original mash. The developed method is very robust and separation of two to four times more concentrated mash should give same separation results.

**Acknowledgement:** This project has received funding from the European Union's Seventh Framework Program for research, technological development and demonstration under grant agreement no FP7-KBBE-2013-7-613802.

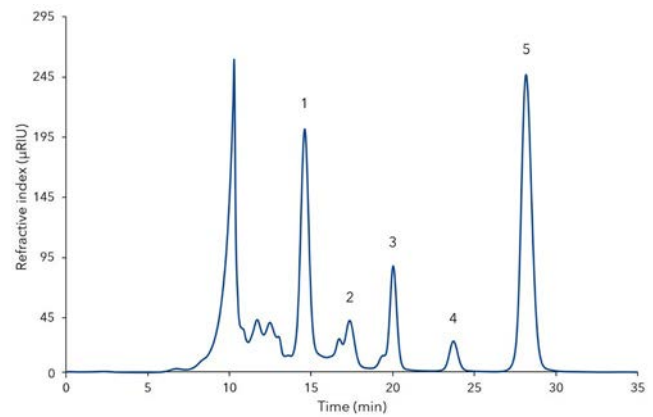


## ADDITIONAL RESULTS



**Fig. A1** Comparison of separation profiles of fermentation mash using Eurokat Ca columns with different length for a fast, analytical method; blue - 2 x 30 x 8 mm (0.7 mL/min), red (offset=-200) - 120 x 8 mm (0.7 mL/min), green (offset=-400) - 300 x 8 mm (0.5 mL/min); 20 µL injection; 75°C; \* - xylitol, \*\* - mannitol

	Concentration (mg/mL)
Xylose	38.44 ± 0.13
Arabinose	8.67 ± 0.04
Glycerol	18.63 ± 0.13
Mannitol	5.59 ± 0.08
Xylitol	61.91 ± 0.34



**Fig. A2** Analytical chromatogram of fermentation mash showing five identified substances; 20 µL injection; Eurokat Ca 300 x 8 mm; 10 µm particles; 0.5 mL/min; 75°C; 1) xylose, 2) arabinose, 3) glycerol, 4) mannitol, 5) xylitol

**Tab. A1** Results of data feed analysis presented as mean of four replicates with standard deviations indicated

## ADDITIONAL MATERIALS AND METHODS

**Tab. A2** Method parameters (SMB process)

	Feed (mL/min)	Eluent (mL/min)
In	0.5	8.36
Temperature	60°C	
Cycle time	54.60 min	

**Tab. A3** System configuration (for Analytical system, see VDF0155)

Instrument	Description	Article No.
SMB system	AZURA Lab SMB system, biocompatible, seven 8-multiposition valves and four AZURA P 4.1S (10/50 mL/min) included in four Assitants ASM 2.1L.	<a href="#">A29000</a>
Heating	SMB oven	<a href="#">A29900</a>
Flow meter	2 x CORI Flow M13	<a href="#">A29800</a>
Column	8 x Eurokat Ca 150 x 20 mm; 25-56 µm	<a href="#">15PX360EK</a>
Software	PurityChrom® MCC	included in <a href="#">A29000</a>

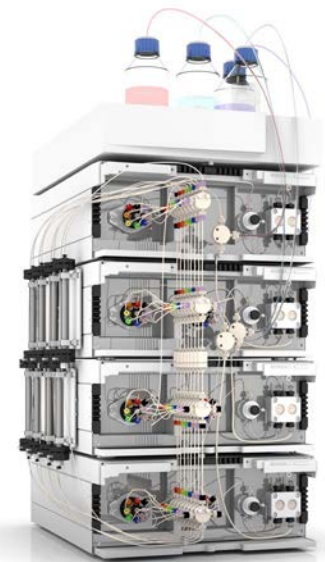
## RELATED KNAUER APPLICATIONS

[VFD0160](#) - Determination of sugars and natural sugar substitutes in different matrices

[VFD0155](#) - Semi preparative xylitol purification with dedicated sugar purification system

[VFD0150](#) - Alternative xylitol extraction via hplc purification from fermented biomass

[VSP0013](#) - Simplified scale up for sugars with the AZURA RID 2.1L extended dynamic range option



[AZURA® Lab SMB System](#)



# Zearalenone and its major metabolites - a simple isocratic method

Juliane Böttcher<sup>1</sup>, Marina Müller<sup>2</sup>, Kate Monks<sup>1</sup>; applications@knauer.net

<sup>1</sup>KNAUER Wissenschaftliche Geräte GmbH, Hegauer Weg 38, 14163 Berlin; www.knauer.net

<sup>2</sup>Leibniz-Zentrum für Agrarlandschaftsforschung e.V., Müncheberg, Germany



## SUMMARY

The Food and Agricultural Organization of the United Nations estimated that 25 % of the global food are contaminated with mycotoxins [1]. Zearalenone (ZON) is a non-polar mycotoxin and a common contaminant in cereal grain used for animal and human food. It exerts an estrogenic activity that disrupts endocrine function in animals and possibly humans. The major metabolites of ZON are  $\alpha$ - and  $\beta$ -zearalenol. All three components can be determined with a robust and simple isocratic method.

## INTRODUCTION

Mycotoxins are secondary metabolites produced by mould fungus. The mycotoxin ZON, which is an intermediate catabolic product of filamentous fungi of the genus *Fusarium*, can be determined on almost all type of cereal. Although the overall toxicity is low, animal testing unraveled teratogenic, hepatotoxic, immunotoxic, genotoxic and cancerogenic effects [2, 3]. ZON furthermore influences the tumor progression of hormonal sensitive tissues as it shows

estrogen-like characteristics.  $\alpha$ - and  $\beta$ -zearalenol are the main metabolites of ZON and mainly formed in the liver but also to a lesser extent in the intestines during first-pass metabolism [4, 5]. A relatively low proportion of  $\beta$ -zearalenol is formed from zearalenone compared to  $\alpha$ -zearalenol in human [4].  $\alpha$ -zearalenol is about 3-to 4-fold more potent as an estrogen relative to zearalenone.



# Zearalenone and its major metabolites – a simple isocratic method

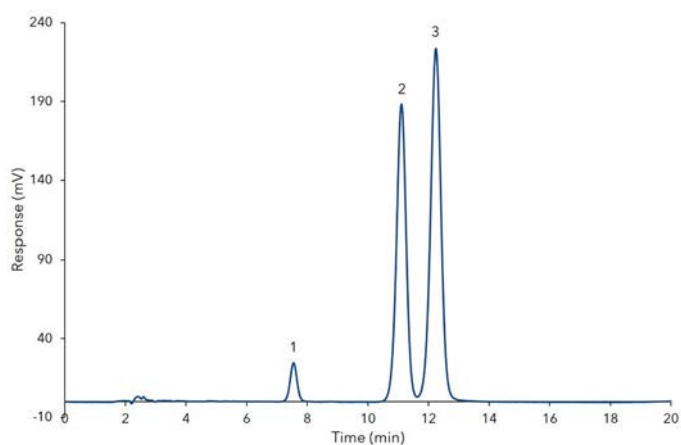
## RESULTS

All samples and standards were provided from the Leibniz-Zentrum für Agrarlandschaftsforschung (ZALF) e.V. In a range from about 2 ng up to 20 ng (absolute) calibrations of all three mycotoxins were determined using six different volumes of the standard ZALF 1. **Tab 1** gives a short summary of the retention times of the substances and achieved correlation coefficients of calibration. **Fig 1** shows the separation of the components in the standard ZALF 1. All peaks are baseline separated. The sample ZALF 2 is made

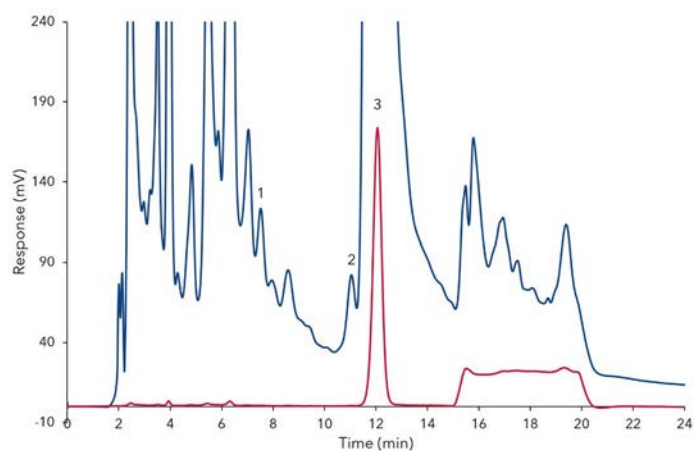
of extracted grain of wheat which were inoculated with a fungus of the genus *Fusarium*. For the determination of zearalenol the sample ZALF 2 was used as provided. For the determination of zearalenone a dilution was necessary. **Fig 2** shows the measurement of the sample ZALF 2 with and without dilution. With quantification based on the determined calibration curves a concentration of 2.80 ng/μL for β-zearalenol, 0.29 ng/μL for α-zearalenol and 390 ng/μL for zearalenone were calculated.

**Tab. 1** Retention times and correlation coefficients of β-Zearalenol, α-Zearalenol and Zearalenone calibration

Peak	Substance	Retention time	Correlation coefficient
1	β-Zearalenol	7.573 min	0.99985
2	α-Zearalenol	11.160 min	0.99997
3	Zearalenone	12.331 min	0.99997



**Fig. 1** Standard ZALF 1: 1) β-Zearalenol, 2) α-Zearalenol, 3) Zearalenone



**Fig. 2** Sample ZALF 2, blue - without dilution, red - 1:50 dilution, 1) β-Zearalenol, 2) α-Zearalenol, 3) Zearalenone

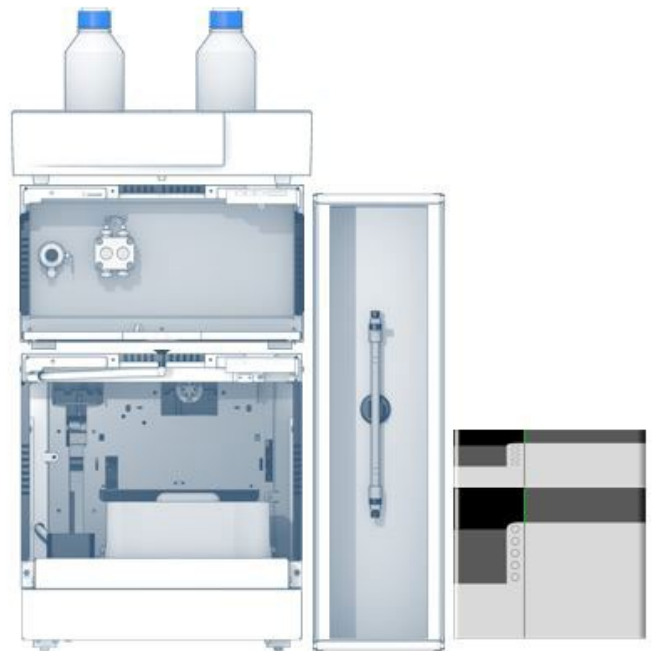
## MATERIALS AND METHODS

An AZURA Analytical HPLC Plus system was used for this application. The system consisted of an isocratic AZURA P 6.1L pump, an AZURA AS 6.1L auto-sampler, an AZURA CT 2.1 column thermostat and a RF 20 Axs fluorescence detector in combination with CBM 20 A under the Chromeleon™ software. The isocratic method [6] was applied for 25 minutes at a flow

rate of 0.65 mL/min with a mixture of methanol and 3 mM phosphoric acid in a ratio 65:35 (v/v). The column temperature was set to 25 °C. The substances were measured with an excitation at 274 nm and emission at 456 nm. The used column in a dimension 150 x 4 mm ID with precolumn was filled with LiChrospher 100-5 RP 18 silica.

## CONCLUSION

It was possible to identify and quantify ZON and its metabolites with the described isocratic method. Using a fluorescence detector for enhanced sensitivity allows measurements of small amounts of mycotoxins even in a complex sample matrix. This application can be used for quality control to make sure the set limit values according to Commission Regulation (EC) No 1881/2006 [7] will be maintained.



## REFERENCES

- [1] W. Mücke, Ch. Lemmen, Schimmelpilze. Vorkommen, Gesundheitsgefahren, Schutzmaßnahme n. Ecomed Verlag, Landsberg am Lech, 2004
- [2] A. Zinedine, J.M. Sorianoet et al., Food and Chemical Toxicology, 2007, 45, 1-18
- [3] M. Weidenbörner, Encyclopedia of Food Mycotoxins, Springer, Berlin, 2001
- [4] Naresh Magan; Monica Olsen (2004). Mycotoxins in Food: Detection and Control. Woodhead Publishing. pp. 356-. ISBN 978-1-85573-733-4.
- [5] G. S. Eriksen (1998). Fusarium Toxins in Cereals: A Risk Assessment. Nordic Council of Ministers. pp. 61-. ISBN 978-92-893-0149-7.
- [6] Dr. Marina Müller, Leibniz-Zentrum für Agrarlandschaftsforschung (ZALF) e.V.
- [7] <http://eur-lex.europa.eu/legal-content/EN/TXT/PDF/?uri=CELEX:32006R1881&from=DE>

## ADDITIONAL MATERIALS AND METHODS

**Tab. A1** Method parameters

Eluent A	Methanol:3 mM phosphoric acid 65:35 (v/v)		
Eluent B	Methanol		
Gradient	Volume [mL]	% A	% B
	0.0	100	0
	13.0	100	0
	13.5	65	35
	18.0	65	35
	18.5	100	0
	25.0	100	0
Flow rate	0.65 mL/min	System pressure	ca. 120 bar
Column temperature	25 °C	Run time	25 min
Injection volume	2-20 µL	Injection mode	Partial loop
Detection wavelength	Ex 274 nm / Em 456 nm	Data rate	100 Hz
		Time constant	0.01 s

**Tab. A2** System configuration

Instrument	Description	Article No.
Pump	AZURA P6.1L, isocratic	<a href="#">APH30EA</a>
Autosampler	AZURA AS 6.1L	<a href="#">AAA00AA</a>
Detector	RF 20Axs with CBM-20A	<a href="#">A59201</a>
Thermostat	AZURA CT 2.1	<a href="#">A05852</a>
Column	LiChrospher 100-5 RP 18, Vertex Plus 150 x 4 mm ID with precolumn	<a href="#">15WE189LSJ</a>
Software	Chromeleon 7.2	

## RELATED KNAUER APPLICATIONS

[VFD0159](#) - *Alternaria alternata* - determination of main metabolites

[VFD0152](#) - Determination of Aflatoxin in milk

# ***Alternaria alternata* - determination of main metabolites**

Juliane Böttcher, Marina Müller<sup>1</sup>, Kate Monks; applications@knauer.net  
KNAUER Wissenschaftliche Geräte GmbH, Hegauer Weg 38, 14163 Berlin; www.knauer.net  
<sup>1</sup>Leibniz-Zentrum für Agrarlandschaftsforschung e.V., Müncheberg, Germany



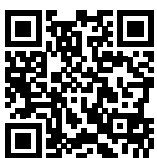
## **SUMMARY**

*Alternaria* toxins represent a possible health-endangering group of mycotoxins produced mainly by the *Alternaria* species. These are a widespread group of fungi contaminating mainly fruits and vegetables, but also other crop plants, during growth as well as storage. The most important mycotoxin-producing species is *Alternaria alternata* which occurs mainly on cereals and seeds [1].

## **INTRODUCTION**

Even though *Alternaria* toxins are normally associated with fruits and vegetables that are visibly infected by *Alternaria* species, they have also been found in cereals, such as wheat, rye, sorghum, rice, and even tobacco. *Alternaria* toxins have been shown to exhibit both acute and chronic effects and therefore represent a threat to animal and human health. The most studied mycotoxin in the group of toxins produced by the species *Alternaria* is tenuazonic acid. Its main function is

the inhibition of protein synthesis and results in anti-tumor, antiviral and antibacterial activity. Most of the other *Alternaria* toxins show cytotoxic activity in mammals, some of them are mutagenic like the altertoxins, while others are toxic to the unborn [1]. This application focusses on the determination of alternariol (AOH), alternariol monomethyl ether (AME), altenuene (ALT) and tenuazonic acid (TeA).



# Alternaria alternata – determination of main metabolites

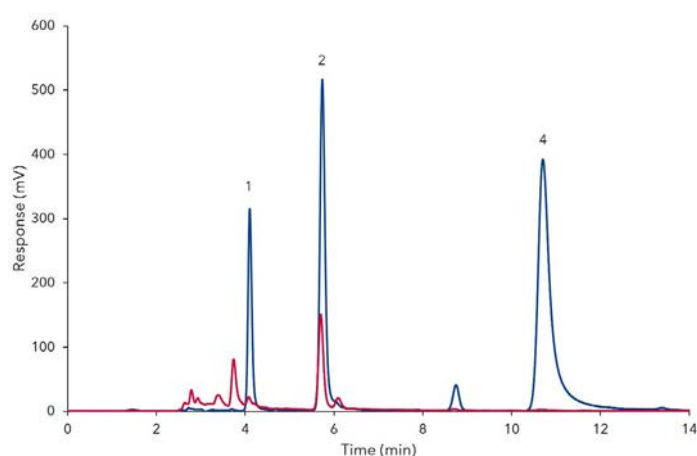
## RESULTS

All samples and standards were provided from the Leibniz-Zentrum für Agrarlandschaftsforschung (ZALF) e.V. [2]. First a calibration was made using the standard ZALF 5 with five different injection volumes. AOH was calibrated in a range from 0.5 ng up to 5.0 ng (absolute), ALT and AME from 1 ng up to 10 ng (absolute) and TeA from 2ng up to 20 ng (absolute). AOH, ALT and AME were detected with a fluorescence detector. TeA was determined using a UV detector. **Tab 1** gives a short summary of the retention times of the substances and achieved correlation coefficients of calibration. As sample an extracted nutrient

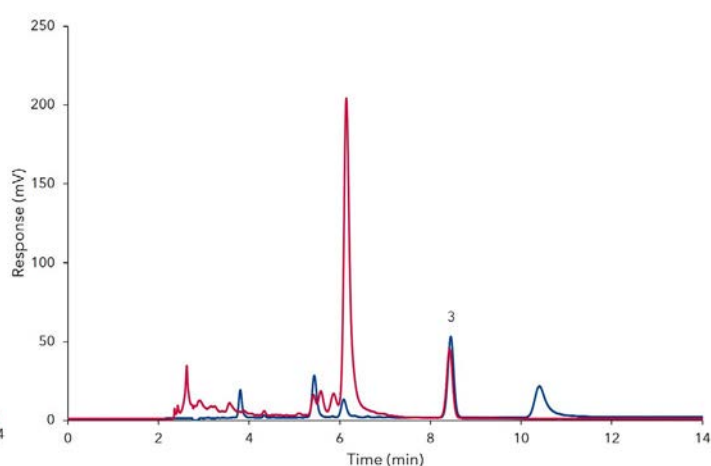
solution of an *Alternaria* strain was used. The extract was divided into two fractions. One for the TeA determination (ZALF 7, dilution 1:20) and one for the other metabolites (ZALF 6, without dilution). **Fig 1** shows an overlay of the fluorescence traces of the standard ZALF 5 and sample ZALF 6. For ALT, a concentration of 1.18 ng/μL was calculated, for AOH 2.74 ng/μL and 0.36 ng/μL for AME. **Fig 2** Shows the UV traces of standard ZALF 5 and sample ZALF 7 for determination of TeA. In the second fraction, a value of 3.44 ng/μL TeA was calculated.

Peak	Substance	Retention time	Correlation coefficient
1	ALT	4.063 min	0.99872
2	AOH	5.698 min	0.99853
3	TeA	8.424 min	0.99917
4	AME	10.664 min	0.99889

**Tab. 1** Retention times and correlation coefficients of altenuene, alternariol, alternariol monomethyl ether and tenuazonic acid calibration



**Fig. 1** Overlay of standard ZALF 5 (blue) and sample ZALF 6 (red), fluorescence detection, 1) ALT, 2) AOH, 3) TeA, 4) AME



**Fig. 2** Overlay of standard ZALF 5 (blue) and sample ZALF 7 (red), UV-detection, 3) TeA

## MATERIALS AND METHODS

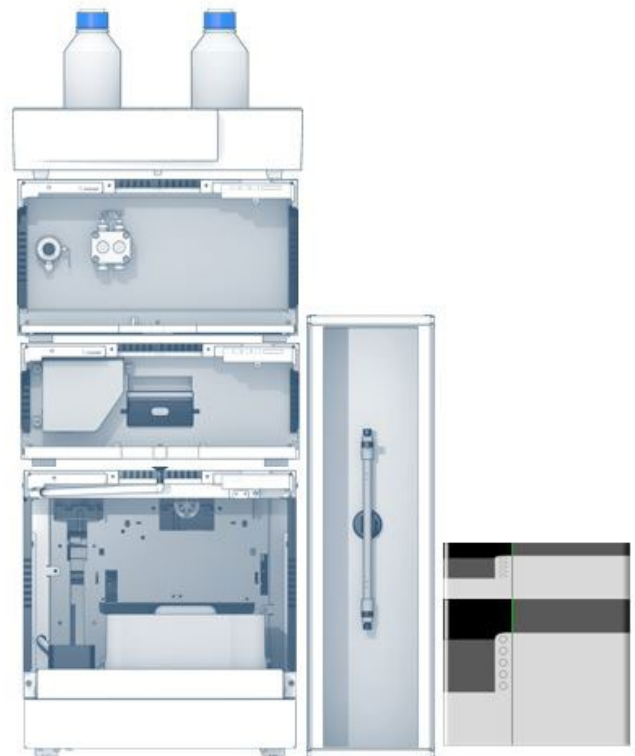
An AZURA® Analytical HPLC Plus system was used for this application. The system consisted of an isocratic AZURA P 6.1L pump, an AZURA AS 6.1L autosampler, an AZURA DAD 6.1L, an AZURA CT 2.1 column thermostat and a RF 20 Axs fluorescence detector in combination with CBM 20 A under the Chromeleon™ software. The isocratic method [2] was applied for 30 minutes at a flow rate of 1 mL/min with a mixture of methanol and water in a ratio 70:30 (v/v). Furthermore 300 mg/mL zinc sulfate were added to the mobile phase. The column temperature was set to 30 °C. The substances were measured with an excitation at 253 nm and emission at 415 nm. The UV detector was set 280 nm. The used column, in a dimension 250 x 4.6 mm ID with precolumn, was filled with Pronosil Hypersorb 120-5 ODS silica.

## REFERENCES

- [1] <https://www.romerlabs.com/en/knowledge-center/knowledge-library/articles/news/alternaria-toxins/>
- [2] Dr. Marina Müller, Leibniz-Zentrum für Agrarlandschaftsforschung (ZALF) e.V.
- [3] <http://www.micotoxinas.com.br/altertoxins.htm>

## CONCLUSION

It was possible to identify and quantify all *Alternaria alternata* metabolites with the described isocratic method. Using a fluorescence detector for enhanced sensitivity allows measurements of small amounts of mycotoxins even in a complex sample matrix. There are currently no statutory or guideline limits set for *Alternaria* mycotoxins because surveys to date have shown that their natural occurrence in foods is low and the possibility for human exposure is limited. The need for regulation is kept under review as new information becomes available [3].



## ADDITIONAL MATERIALS AND METHODS

**Tab. A1** Method parameters

Eluent A	Methanol:Water 70:30 (v/v) with 300 mg/L ZnSO <sub>4</sub> x 7 H <sub>2</sub> O		
Gradient	isocratic		
Flow rate	1 mL/min	System pressure	ca. 160 bar
Column temperature	30 °C	Run time	30 min
Injection volume	1-10 µL	Injection mode	Partial loop
Detection UV	280 nm	Data rate	50 Hz
		Time constant	0.02 s
Detection FLD	Ex 253 nm / Em 415 nm	Data rate	100 Hz
		Time constant	0.01 s

**Tab. A2** System configuration

Instrument	Description	Article No.
Pump	AZURA P6.1L, isocratic	<a href="#">APH30EA</a>
Autosampler	AZURA AS 6.1L	<a href="#">AAA00AA</a>
Detector	RF 20Axs with CBM-20A	<a href="#">A59201</a>
Detector	AZURA DAD 6.1L	<a href="#">ADC11</a>
Flow cell	LightGuide 50 mm, 6 µL	<a href="#">AMD59XA</a>
Thermostat	AZURA CT 2.1	<a href="#">A05852</a>
Column	Prontosil Hypersorb 120-5 ODS, VertexPlus Column 250 x 4.6 mm ID with precolumn	<a href="#">25VF180PYJ</a>
Software	Chromeleon 7.2	

## RELATED KNAUER APPLICATIONS

[VFD0158](#) - Zearalenone and its major metabolites - a simple isocratic method

[VFD0152](#) - Determination of Aflatoxin in milk



# Determination of sugars and natural sugar substitutes in different matrices

Juliane Böttcher, Hagen Schlicke, Kate Monks; applications@knauer.net  
KNAUER Wissenschaftliche Geräte GmbH, Hegauer Weg 38, 14163 Berlin; www.knauer.net



## SUMMARY

Nowadays sugar substitutes are used in many products, not only for diabetic purposes but to make products more attractive for customers. Furthermore, people are interested in a healthier lifestyle which includes consuming less sugar. Therefore, a quality control of sugar and sugar substitutes in food and beverages needs to be compulsory, to assure the correct composition of ingredients.

## INTRODUCTION

Sweet taste is favored by human beings. People instinctively desire the pleasure of sweetness, which resulted in a preference for sweet foods and beverages [1]. But sugar is rich in calories and that is why a lot of people are switching to light products containing sugar substitutes. These products contain less calories and are often obtained from natural crude materials. e.g. wood fibers of the birch. This application will

focus on the determination of commonly used sugars and natural sugar substitutes. Sucralose (E 955) is a high-intensity sweetener, about 600 times higher than saccharose. Mannitol (E 421) and sorbitol (E 420) have about half the intensity of saccharose and xylitol (E 967) has a quite equal intensity as commonly used sugar [2].



# Determination of sugars and natural sugar substitutes in different matrices

## RESULTS

A mixed standard of saccharose, sucralose, glucose, fructose, mannitol, xylitol, and sorbitol was used for calibration in a range from 0.25 mg/mL up to 2.0 mg/mL. Five different samples of caffeinated soft drinks as well as one sample of chewing gum and one sample of tooth paste were analyzed. Various compositions and contents of the analytes in the samples were determined (Tab A1, additional results).

Fig 1 shows a chromatogram of sample 5 compared to the standard mix. It reveals that this sample contains saccharose, glucose, and fructose exclusively. The analyzed chewing gum and tooth paste contain only mannitol, xylitol, and sorbitol. Additional peaks were observed in both chromatograms but are not related to the substances in the standard mix (Fig 2 & 3).

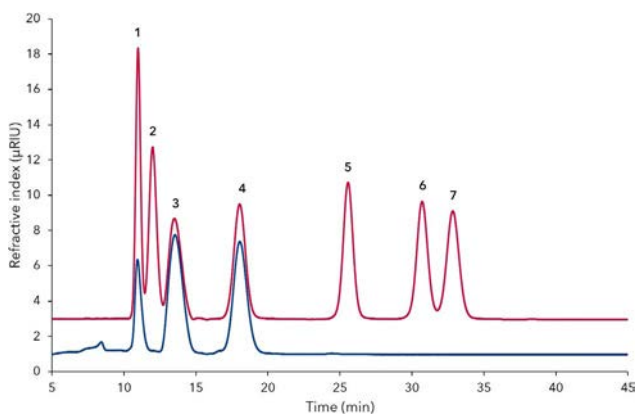


Fig.1 Overlay of mixed standard (red) and Guarana soft drink with sugar (dilution 1:30, blue), 1) saccharose, 2) sucralose, 3) glucose, 4) fructose, 5) mannitol, 6) xylitol, 7) sorbitol

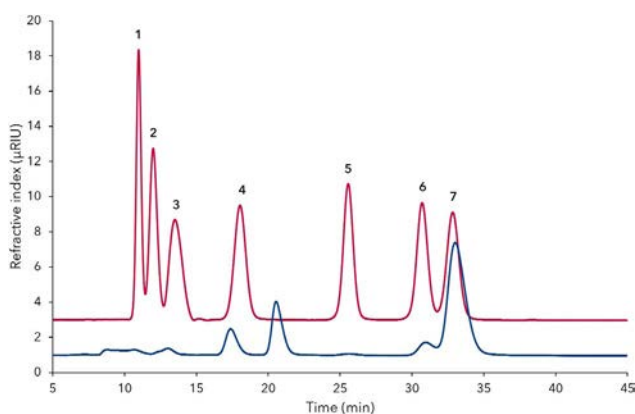


Fig.2 Overlay of mixed standard (red) and extracted tooth paste (blue), 1) saccharose, 2) sucralose, 3) glucose, 4) fructose, 5) mannitol, 6) xylitol, 7) sorbitol

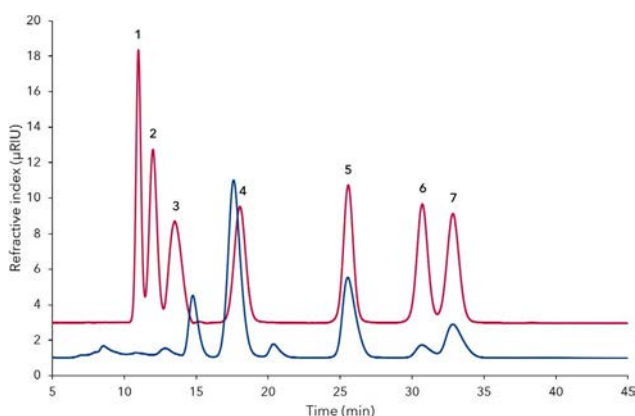


Fig.3 Overlay of mixed standard (red) and extracted chewing gum (blue), 1) saccharose, 2) sucralose, 3) glucose, 4) fructose, 5) mannitol, 6) xylitol, 7) sorbitol

## MATERIALS AND METHODS

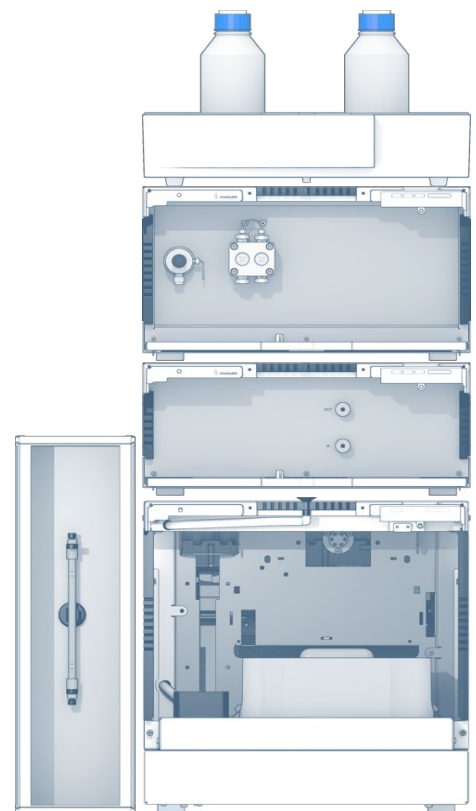
The AZURA® dedicated system for sugar analytics with an additional autosampler was used for this application. The system consisted of an isocratic AZURA P 6. 1L pump, an AZURA autosampler AS 6.1L, an AZURA CT 2.1 column thermostat, an AZURA RID 2.1L refractive index detector and an Eurokat Ca column in a dimension 300 x 8 mm ID with precolumn 30 x 8 mm ID filled with the same material. Eurokat Ca is a sulfonated cross-linked styrene-divinylbenzene copolymer. The isocratic method ran 45 minutes at a flow rate of 0.5 mL/min with 100 % aqueous eluent. The column thermostat was set to 60 °C and the data rate of the detector to 20 Hz. 20 µL of samples and standards were injected.

## REFERENCES

- [1] <https://www.ncbi.nlm.nih.gov/pmc/articles/PMC3098376/>
- [2] <https://www.bzfe.de/inhalt/kennzeichnung-von-zusatzstoffen-1881.html>

## CONCLUSION

The presence of natural sugar substitutes besides sugars in the same sample matrix is not prevalent but quite feasible. It can be seen, that the caffeinated soft drinks only contained sugar and no sugar substitutes. As expected the soft drinks which were declared to be "light" had no measurable amount of sugars. The extracted tooth paste and chewing gum were specified to be sugar-free but contain sugar substitutes. The detection of mannitol, xylitol or sorbitol was as expected. With the described method it is possible to identify the most commonly used sugars and natural sugar substitutes in one run. With little effort in sample preparation it is even contingent to determine these substances from solid samples such as chewing gum or tooth paste.



## ADDITIONAL RESULTS

Tab. A1 Results of sample measurements (n.d. = not detectable)

Peak	Substance	Sample 1 (with sugar) in mg/mL	Sample 2 (light) in mg/mL	Sample 3 (light) in mg/mL	Sample 4 (Bio, with sugar) in mg/mL	Sample 5 (Guarana with sugar) in mg/mL	Sample 6 (chewing gum) in g/100 g	Sample 7 (tooth paste) in g/100 g
1	Saccharose	47.84	n.d.	n.d.	n.d.	8.54	n.d.	n.d.
2	Sucralose	n.d.	n.d.	n.d.	n.d.	n.d.	n.d.	n.d.
3	Glucose	17.12	n.d.	n.d.	37.58	30.60	n.d.	n.d.
4	Fructose	15.60	n.d.	n.d.	34.82	26.52	n.d.	n.d.
5	Mannitol	n.d.	n.d.	n.d.	n.d.	n.d.	10.98	0.23
6	Xylitol	n.d.	n.d.	n.d.	n.d.	n.d.	5.84	2.11
7	Sorbitol	n.d.	n.d.	n.d.	n.d.	n.d.	5.84	19.71

## ADDITIONAL MATERIALS AND METHODS

Tab. A2 Method parameters

Eluent	Water		
Gradient	isocratic		
Flow rate	0.5 mL/min	System pressure	ca. 35 bar
Column temperature	60 °C	Run time	45 min
Injection volume	20 µL	Injection mode	Full loop
Detection	RI	Data rate	20 Hz
		Time constant	0.05 s

Tab. A3 System configuration

Instrument	Description	Article No.
Pump	AZURA P6.1L, isocratic	<a href="#">APH30EA</a>
Autosampler	AZURA AS 6.1L	<a href="#">AAA00AA</a>
Detector	AZURA RID 2.1L	<a href="#">ADD31</a>
Thermostat	AZURA CT 2.1	<a href="#">A05852</a>
Column	Vertex Plus Column, 300 x 8 mm, Eurokat Ca, 10 µm Vertex Plus Column, 30 x 8 mm, Eurokat Ca, 10 µm	<a href="#">30GX360EKN</a> <a href="#">03GX360EKN</a>
Software	ClarityChrom 7.2	<a href="#">A1670-11</a>



Dedicated AZURA® Sugar Analytical System

## RELATED KNAUER APPLICATIONS

[VFD0161](#) - Determination of sugars in honey using HILIC separation and RI detection

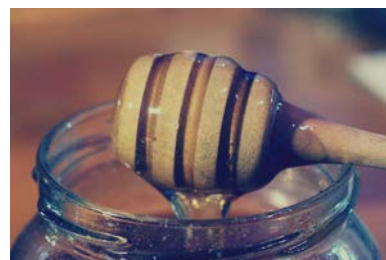
[VFD0155](#) - Semi preparative xylitol purification with dedicated sugar purification system

[VFD0150](#) - Alternative xylitol extraction via hplc purification from fermented biomass

[VSP0013](#) - Simplified scale up for sugars with the AZURA RID 2.1L extended dynamic range option

# Determination of sugars in honey using HILIC separation and RI detection

Hagen Schlicke, Kate Monks; [applications@knauer.net](mailto:applications@knauer.net)  
KNAUER Wissenschaftliche Geräte GmbH, Hegauer Weg 38, 14163 Berlin; [www.knauer.net](http://www.knauer.net)



## SUMMARY

Honey is one of the most popular natural foods and the consumption has grown in the last few decades. Hydrophilic-interaction chromatography was used for the separation of mono- and disaccharides to distinguish between honey and honey substitute products. The dedicated AZURA® Sugar Analytical System with autosampler upgrade is perfectly suitable for this application.

## INTRODUCTION

There are well over 50 different kinds of honey on the market, which differ in consistency, color, and taste. In Germany, the honey ordinance differentiates honey according to the origin, type of extraction, the form of supply or the intended use. Natural bee honey consists of approx. 39 % fructose and approx. 34 % glucose. [1] For example, blossom honey (Blütenhonig) must contain at least 60 % fructose and glucose [2]. In addition, small amounts of sucrose or maltose can be detected [1]. Internationally, products containing

more than 5 % sucrose or maltose must no longer be labeled as „pure“ honey [3]. The Association of Official Analytical Chemist (AOAC) designed a method for the analysis of sucrose, fructose, and glucose in honey (AOAC 977.20). Based on this method, we used an Eurospher II NH2 column for hydrophilic-interaction chromatography (HILIC). Two different commercially available honeys and two substitutes were analyzed to illustrate the differences between these products.



# Determination of sugars in honey using HILIC separation and RI detection

## RESULTS

The carbohydrates fructose, glucose, sucrose, and maltose were separated in 12 min with an isocratic method (Fig 1). All sugars could be quantified in a range of mg per 100 g standard sample. Thereby the lowest concentration measured in the standard mix used for the calibration was 0.39 mg/mL (Fig A1). All four sugars followed a linear calibration fit and had R2 coefficients >0.999 (n=6, data not shown). The composition of the sugars in the examined samples differed greatly between the honey and the substitute products (Fig 2). The agave nectar had a much

higher content of fructose whereas honey substitute had only 1.24 g fructose per 100 g sample. The content of maltose was greatly increased in the honey substitute compared to the honey and the agave nectar samples. The two honey samples each contained more fructose than glucose. The total sugar content of bee honey and blossom honey was around 77 % and 74 %, respectively. No detectable amounts of sucrose were found in bee honey and agave nectar which additionally contained no maltose (Tab. 1).

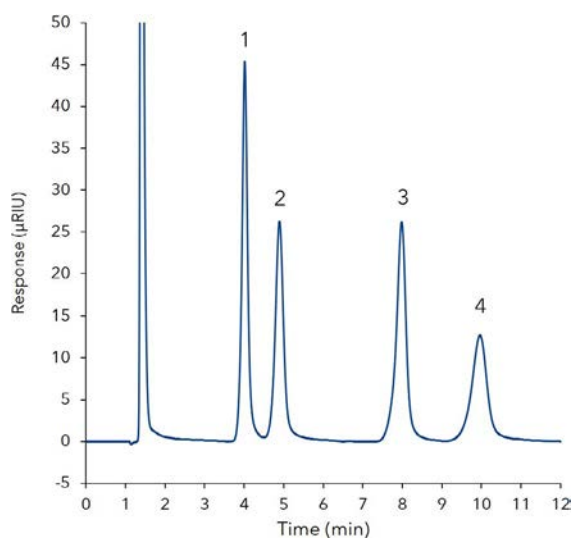


Fig. 1 Overlay of 12 replicates of the 12.5 mg/mL sugar standard containing 1) fructose, 2) glucose, 3) sucrose, 4) maltose

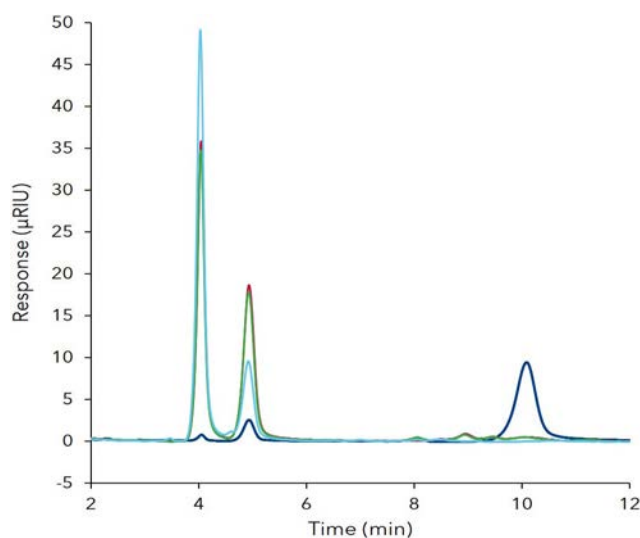


Fig. 2 Overlaid chromatograms of two honey and two honey substitute samples; blue - honey substitute, red - bee honey, green - blossom honey, light blue - agave nectar

Tab. 1 Quantitative results of two honeys and two honey substitutes

Sample	Fructose (g/100 g)	Glucose (g/100 g)	Sucrose (g/100 g)	Maltose (g/100 g)	Sugar content (%)
Honey substitute	1.24 ±0.04	5.18 ±0.21	1.17 ±0.07	35.15 ±0.73	42.74
Bee honey	39.09 ±0.13	35.32 ±0.67	0.00 ±0.00	2.98 ±0.22	77.39
Blossom honey	37.50 ±0.15	33.27 ±0.56	1.12 ±0.05	2.37 ±0.30	74.27
Agave nectar	53.98 ±0.12	18.98 ±0.73	0.00 ±0.00	0.00 ±0.00	72.96

## MATERIALS AND METHODS

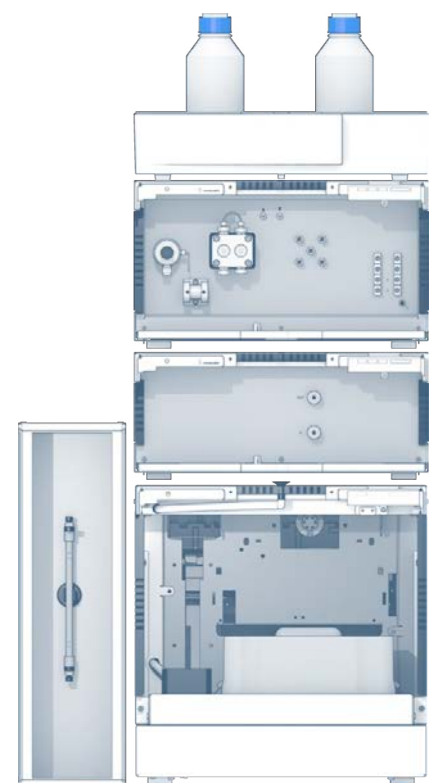
The AZURA® dedicated system for sugar analytics with an additional autosampler was used for this application. The system consisted of an isocratic AZURA P 6.1L pump, an AZURA AS 6.1L autosampler, an AZURA CT 2.1 column thermostat, an AZURA RID 2.1L refractive index detector, and an Eurospher II 100-3 NH2 150 x 4 mm column with pre-column. The isocratic method run for 12 min at a flow rate of 1.2 mL/min with 80 % acetonitrile used as eluent. The column thermostat was set to 35 °C, the data rate of the detector was set to 20 Hz, and 5 µL of sample and standards were injected. The four standards were first dissolved in water 1:40 (w/v), then mixed 1:1:1:1 (v/v/v/v), filtered (0.45 µm) and finally diluted 1:1 (v/v) with acetonitrile to achieve a 12.5 mg/mL stock solution. The samples were dissolved in water 1:20 (w/v), filtered (0.45 µm), and diluted 1:1 (v/v) with acetonitrile before injection.

## CONCLUSION

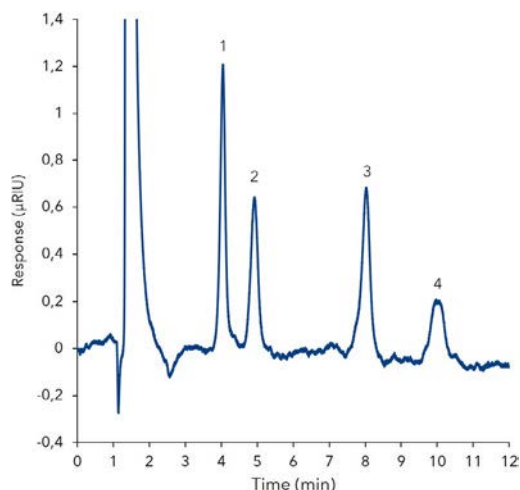
The honey samples contained more than 60% fructose and glucose, as expected. The ratio of fructose and glucose was also typical of honey. The more glucose a honey has, the faster it tends to crystallize. The examined honey substitute and agave nectar showed a different kind of sugar pattern. The high maltose content indicates that honey substitute is not a natural product such as honey. Natural honey normally contains high concentrations of glucose and fructose and, in proportion, substantially less maltose. The data demonstrated the effective chromatographic separation of fructose, glucose, sucrose, and maltose using the AZURA dedicated system and an excellent linearity and retention time repeatability. In addition to the determination of sugars this application can also be used to differentiate between natural products such as honey and possible substitutes of the food industry.

## REFERENCES

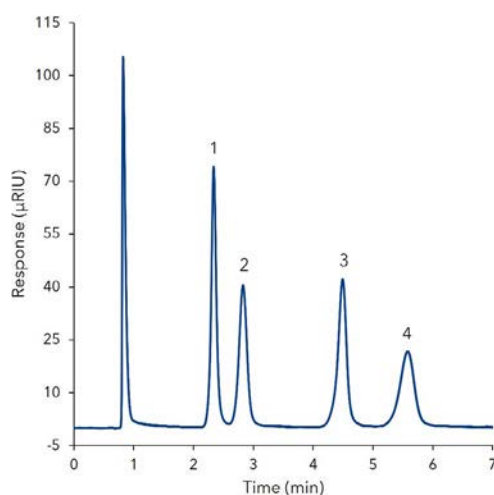
- [1] AID Zucker, Sirupe, Honig, Zuckeraustauschstoffe und Süßstoffe (Nr. 1157)
- [2] Honigverordnung vom 16. Januar 2004 (BGBl I S. 92)
- [3] Codex Alimentarius Commission, 2001; GB18796-2005, 2005



## ADDITIONAL RESULTS



**Fig. A1** Chromatogram of the 0.39 mg/mL sugar standard; 1) fructose, 2) glucose, 3) sucrose, 4) maltose



**Fig. A2** Overlaid chromatograms of sugar standard. 1) fructose, 2) glucose, 3) sucrose, 4) maltose; Increasing the flow rate to 2 mL min reduces the run time to 7 min. The overlay of the 6 runs shows that the method still has a high reproducibility. However, it should be noted that the lifetime of the column is shortened under these conditions and a regular calibration is recommended

## ADDITIONAL MATERIALS AND METHODS

**Tab. A1** Method parameters

Eluent	80% Acetonitrile gradient grade		
Gradient	isocratic		
Flow rate	1.2 mL/min	Run time	12 min
Column temperature	35 °C	Injection mode	Full loop
Injection volume	5 µL	Data rate	10 Hz
Detection	RI		

**Tab. A2** System configuration & data

Instrument	Description	Article No.
Pump	AZURA® P6.1L, LPG	<a href="#">APH39EA</a>
Autosampler	AZURA® AS 6.1L	<a href="#">AAA00AA</a>
Detector	AZURA® RID 2.1L	<a href="#">ADD31</a>
Column	Eurospher II 100-3 NH2 150 x 4 mm with precolumn	<a href="#">15WE190E2G</a>
Thermostat	AZURA® CT 2.1	<a href="#">A05852</a>
Software	ClarityChrom 7.2	<a href="#">A1670-11</a>



**Dedicated AZURA® Sugar Analytical System**

## RELATED KNAUER APPLICATIONS

[VFD0160](#) - Determination of sugars and natural sugar substitutes in different matrices

[VFD0155](#) - Semi preparative xylitol purification with dedicated sugar purification system

[VFD0150](#) - Alternative xylitol extraction via hplc purification from fermented biomass

[VSP0013](#) - Simplified scale up for sugars with the AZURA RID 2.1L extended dynamic range option



# Separation of ascorbic acid and vitamin B complexes - essentially required nutrients



Stefan Weiz, Juliane Böttcher, Kate Monks; applications@knauer.net  
KNAUER Wissenschaftliche Geräte GmbH, Hegauer Weg 38, 14163 Berlin; www.knauer.net

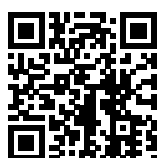
## SUMMARY

Vitamins can be divided into fat-soluble and water-soluble vitamins. Water-soluble vitamins dissolve in water, which means these vitamins and nutrients dissolve quickly in the body. Examples for water soluble vitamins are vitamin C and the vitamin B complex: thiamin (B1), riboflavin (B2), niacin (B3), pantothenic acid (B5), vitamin B6, biotin (B7), folic acid (B9), cyanocobalamin (vitamin B12). In this work, eight water-soluble vitamins were separated and quantified in less than 10 min.

## INTRODUCTION

Water-soluble vitamins are essential nutrients that an organism requires in limited amounts. All B-vitamins and C-vitamin are water-soluble vitamins. They are distributed in all watercontaining areas of the body, for example in blood or in cell interstices. Water-soluble vitamins are hardly stored in the body, only vitamin B12 can be stored in the liver. Therefore, a consistent intake is important, which can be achieved with one of the dietary supplement on the market. Vitamin B12 supplements are particularly important for individuals following a vegan diet. Qualitative and

quantitative analysis of vitamins in dietary supplements is a challenging task since vitamins are relatively unstable and vitamins are a mix of neutral, acidic and basic compounds. In the consecutively described results the separation of the vitamin B-complexes such as ascorbic acid, nicotinic acid, thiamine, pyridoxine, nicotinamide, cyanocobalamin (synthetic form of vitamin B12) and riboflavin is described. The method includes a wavelength switching step at 5.5 min to get the highest sensitivity for cyanocobalamin.



# Separation of ascorbic acid and vitamin B complexes - essentially required nutrients

## RESULTS

The absorption spectrum of cyanocobalamin shows a specific band at 360 nm, but at 220 nm the molar attenuation coefficient is higher (Fig 1). For the measurement of ascorbic acid and thiamine it is important, that the pH of the sample is set to a value of 3.0. It is recommended to use a 20 mmol potassium dihydrogenphosphate buffer adjusted to pH 3.0. In comparison, the eluent has a pH of 4.25. For ascorbic acid

the limit of quantification (LOQ, S/N=10) is 66 µg/L, for nicotinic acid 107 µg/L, for thiamine 1406 µg/L, for pyridoxine 2183 µg/L, for nicotinamide 162 µg/L, cyanocobalamin 145 µg/L and for riboflavin 462 µg/L. Fig 2 shows the chromatogram of a mixed vitamin B standard. The folic acid was not stable under the applied test conditions.

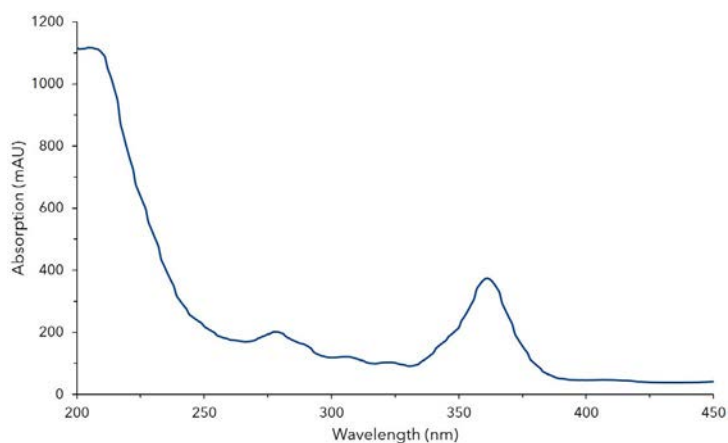


Fig. 1 Absorption spectrum of cyanocobalamin

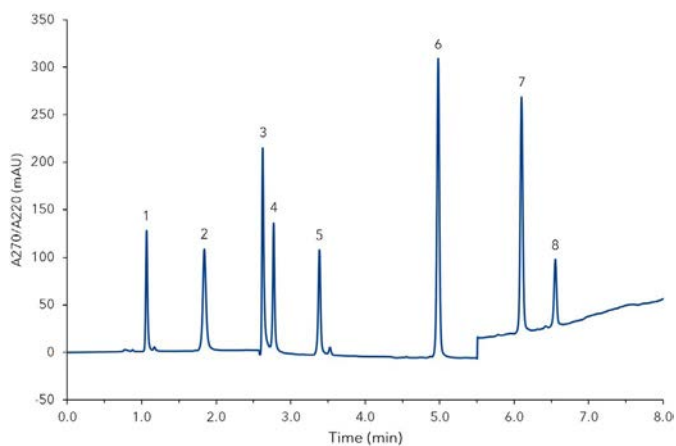


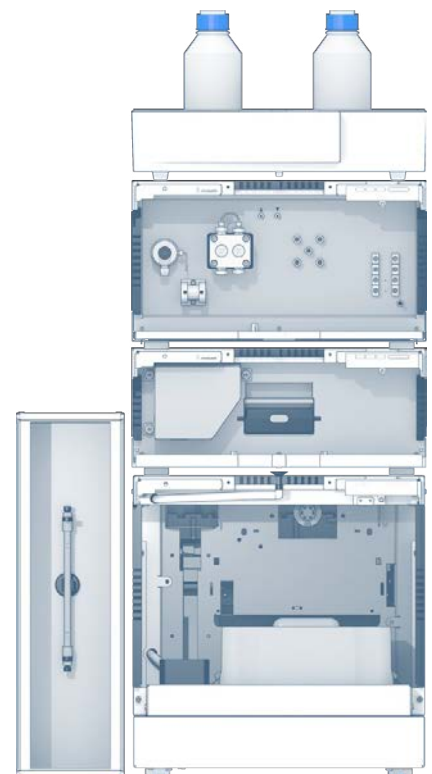
Fig. 2 Chromatogram of standard mix, 1) ascorbic acid, 2) nicotinic acid, 3) thiamine, 4) pyridoxine, 5) nicotinamide, 6) folic acid, 7) cyanocobalamin, 8) riboflavin

## MATERIALS AND METHODS

An AZURA® UHPLC system was used for this application. The system consisted of an AZURA P 6.1L LPG pump, an AZURA AS 6.1L autosampler, an AZURA DAD 6.1L with a High Sensitivity LightGuide flow cell and an AZURA CT 2.1 column thermostat. Analysis was performed using the OpenLAB EZChrom Edition chromatography software. The samples were diluted in 20 mmol potassium dihydrogenphosphate buffer pH 3.0 and filtered over 0.45 µm pore size syringe filter. 10 µL of each sample was injected onto a 150 x 3 mm ID column, filled with Eurospher II 100-3 C18 A silica. The samples were separated at 30 °C at a flow rate of 1 mL/min with a linear gradient of 20 mmol potassium dihydrogenphosphate pH 4.25 adjusted with phosphoric acid (A) and acetonitrile (B) (0 - 30 % B in 8.5 min). At the beginning the detection wavelength was set to 270 nm and then switched to 220 nm at 5.5 min.

## CONCLUSION

All components could be clearly be qualified and quantified. The wavelength switching increased the sensitivity of the method for the determination of cyanocobalamin (vitamin B12). This fast and sensitive method could be used for quality control of supplementary products.



## ADDITIONAL MATERIALS AND METHODS

Tab. A1 Method parameters

Eluent A	20 mmol potassium dihydrogenphosphate pH 4.25 (adjusted with phosphoric acid)		
Eluent B	Acetonitrile		
Gradient	Time (min)	% A	% B
	0.0	100	0
	0.5	100	0
	9.0	70	30
	12.0	70	30
	15.0	100	0
	20.0	100	0
Flow rate	1.0 mL/min	Run time	20 min
Column temperature	30°C	Injection mode	Full loop
Injection volume	10 µL	Data rate	20 Hz
		Time constant	0.05 sec
<b>Detection wavelength switching</b>			
<b>Time (min)</b>	<b>nm</b>		
0.0	270		
5.5	220		
19	270		

Tab. A2 System configuration

Instrument	Description	Article No.
Pump	AZURA® P6.1L, LPG 5 ml	<a href="#">APH34GA</a>
Autosampler	AZURA® AS 6.1L	<a href="#">AAA10AA</a>
Detector	AZURA® DAD 6.1L	<a href="#">ADC11</a>
Flow cell	LightGuide 50mm, 6µL	<a href="#">AMDS9XA</a>
Column	Eurospher II 100 3 C18 A , Vertex Plus Column 150 x 3 mm ID	<a href="#">15CE184E2G</a>
Thermostat	AZURA® CT 2.1	<a href="#">A05852</a>
Software	OpenLAB CDS EZChrom Edition	<a href="#">A2600-1</a>

## RELATED KNAUER APPLICATIONS

[VFD0172](#) - A D E K - Separation of fat-soluble vitamins using GPC/SE

[VFD0152](#) - Determination of Aflatoxin M1 in milk

[VFD0158](#) - Zearalenone and its major metabolites - a simple isocratic method

[VFD0159](#) - *Alternaria alternata* - determination of main metabolites

[VFD0160](#) - Determination of sugars and natural sugar substitutes in different matrices

[VFD0161](#) - Determination of sugars in honey using HILIC separation and RI detection

# Natural or artificial? - Determination of vanillin in vanilla products and associated marker substances

Juliane Böttcher, Kate Monks - applications@knauer.net  
KNAUER Wissenschaftliche Geräte GmbH,  
Hegauer Weg 38, 14163 Berlin - www.knauer.net



## SUMMARY

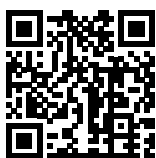
Vanillin is one of the most popular flavouring agents used in various food products, beverages, as well as in the pharma and perfume industry. With a high demand for the supply of vanilla pods and the continuous increase in price, artificial vanilla flavouring agents of synthetic origin are nowadays highly requested [1]. With this application the components of different vanilla products can be analysed. This is useful i.a. for the first screening concerning the authenticity.

## INTRODUCTION

The high demand for vanillin far exceeds the supply from all sources covered by vanilla orchids which are the only source for the "real" vanilla flavour called "Bourbon vanilla". The high price of natural vanillin, compared with that of synthetic vanillin, and the poor availability are the reasons to produce vanillin via chemical synthesis since the 1870s. These processes use coniferin, guaiacol, or eugenol as a precursor [2]. Biotechnological processes like fermentation that use ferulic acid and rice bran as precursors of vanillin are relatively new. Biotechnologically produced vanillin is much more cost intensive than chemically synthesized vanillin. However, but the biotechnically produced products are allowed to use the designation "natural vanilla flavour". Chemically synthesized flavours must use the name "vanilla flavour". Some substances from the chemical or biotechnological manufacturing processes are unwanted in food products due to negative health effects. This makes an analytical

control indispensable. These molecules as well as the precursors used in the chemical synthesis are appropriate markers for the differentiation between synthetic vanilla flavour and Bourbon vanilla extract. While an exact statement about the origin of vanilla flavour is only possible after complex analytical methods like isotopic analysis, a first statement about the origin of vanilla flavour is already possible by screening for marker substances using HPLC methods. Therefore, in this work ethanolic extracts of vanillin containing samples are analysed to find marker substances as an association for the origin of the flavour.

Here, 4-hydroxybenzoic acid, vanillic acid, and 4-hydroxybenzaldehyde were analysed in addition to vanillin as typically occurring substances in Bourbon vanilla extract. Furthermore, guaiacol, coumarin, and eugenol were analysed as markers for synthetic vanilla flavour and unwanted precursors [3].



# Natural or artificial? – Determination of vanillin in vanilla products and associated marker substances

## RESULTS

A mixed standard of the seven compounds was used for calibration. The separation of the standard was achieved in under 4 minutes. All calibration curves showed a good linearity with  $R^2 > 0.9999$ . The detailed concentrations for each level are summarized in **Tab. 1**.

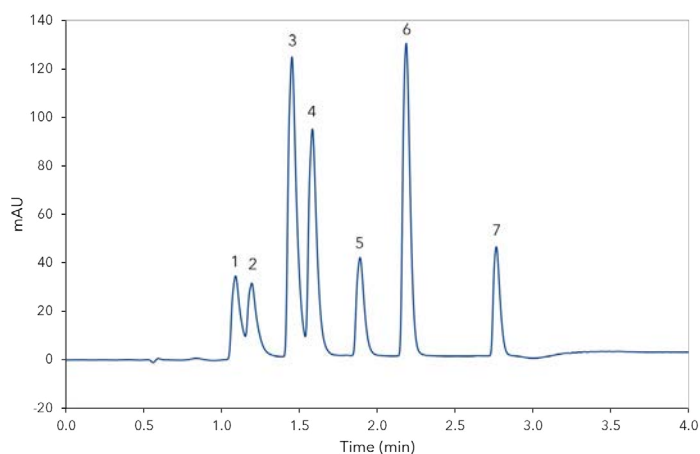
**Fig. 1** shows exemplarily the separation of the mixed standard at level 3. Four different samples were extracted and analysed: vanilla bean, bourbon vanilla sugar, vanillin sugar, and vanilla baking aroma. All samples were extracted with ethanol. The detailed sample preparation is described in the additional results section (**Tab. A2**).

**Fig. 2** shows the chromatogram of the extracted vanilla bean sample. The sample profile shows a high amount of vanillin and as expected the marker substances for Bourbon vanilla origin.

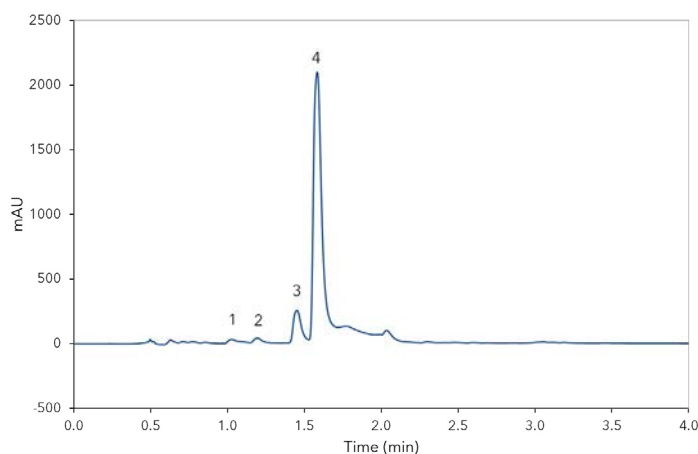
4-hydroxybenzoic acid, vanillic acid and 4-hydroxybenzaldehyde were also measured. The total amounts of vanilla compounds are summarized and calculated in **Tab. A1** (additional result section). **Tab. 1** shows the determined values for LOD ( $S/N=3$ ) and LOQ ( $S/N=10$ ) for this method. The chromatograms of the other analysed samples are also displayed in the additional section.

**Tab. 1** Concentration of calibration levels and calculated LOD and LOQ

Substance	Level 1 mg/mL	Level 2 mg/mL	Level 3 mg/mL	Level 4 mg/mL	Level 5 mg/mL	LOD S/N=3 in µg/mL	LOQ S/N=10 in µg/mL
4-hydroxybenzoic acid	0.014	0.028	0.056	0.070	0.140	0.860	2.860
4-hydroxybenzaldehyde	0.010	0.020	0.040	0.050	0.100	0.180	0.610
Vanillin	0.015	0.030	0.060	0.075	0.150	0.350	1.150
Guaiacol	0.023	0.046	0.092	0.115	0.230	1.310	4.380
Coumarin	0.014	0.028	0.056	0.070	0.140	0.240	0.800
Eugenol	0.022	0.044	0.088	0.110	0.220	1.010	3.350
Vanillic acid	0.010	0.020	0.040	0.050	0.100	0.630	2.100



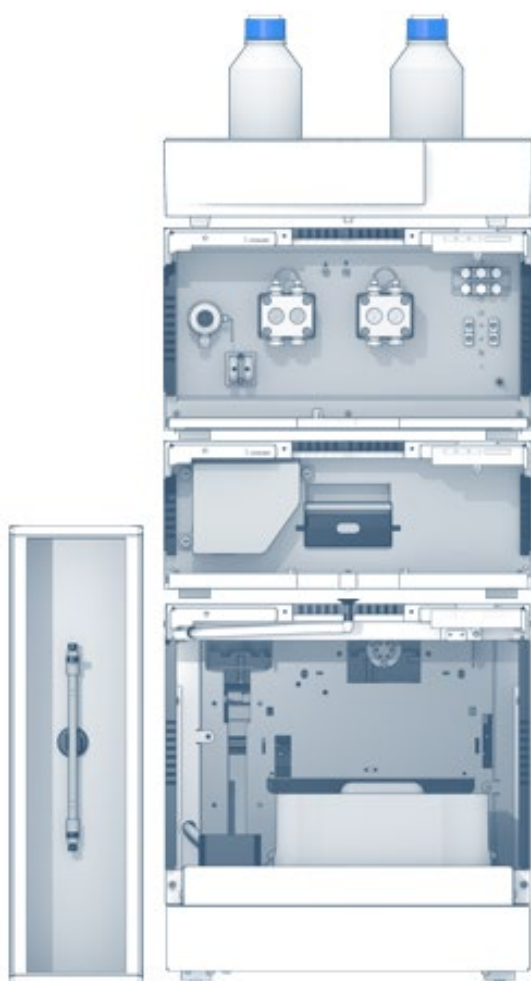
**Fig. 1** Mixed standard at concentration Level 3, 1) 4-hydroxybenzoic acid, 2) vanillic acid, 3) 4-hydroxybenzaldehyde, 4) vanillin, 5) guaiacol, 6) coumarin, 7) eugenol



**Fig. 2** Chromatogram of extracted vanilla bean, 1) 4-hydroxybenzoic acid, 2) vanillic acid, 3) 4-hydroxybenzaldehyde, 4) vanillin

## MATERIALS AND METHOD

Here, the AZURA® UHPLC system was used which consisted of an AZURA P 6.1L HPG pump, an autosampler AZURA AS 6.1L, a column thermostat CT 2.1, and an AZURA MWD 2.1L. The flow was set to 0.5 mL/min at a temperature of 40 °C. 1 µL of the samples and standards was injected. Detection took place at 280 nm. The mobile phase is a gradient composition of A: water with 0.05 % trifluoroacetic acid and B: acetonitrile with 0.1 % trifluoroacetic acid. The column was filled with Eurospher II 100-2 C18A silica in a dimension 100x2 mm ID.



## CONCLUSION

According to the BLL guidelines for vanilla sugar and vanillin sugar from 2007 [4], vanilla sugar is a mixture of saccharose and crushed vanilla beans. Vanillin sugar, however, is a composition of saccharose and vanillin. Due to the calculated amounts in **Tab. A1**, the analysed Bourbon vanilla sugar contains vanillin as well as 4-hydroxybenzaldehyde, a marker for a natural vanilla flavour. The vanillin sugar on the other hand contains more vanillin and also a high amount of guaiacol which indicates its artificial/synthetic origin. The vanilla baking aroma contained the highest amount of vanillin but also residues of all other compounds. Since for the analysed aroma no declaration of composition is necessary, it could contain natural vanilla as well as synthetic aroma ingredients [5]. The shown UHPLC method allows a first and fast quality control of vanilla products regarding the marker substances for synthetic or natural based extracts. Besides the isotopic analysis there are characteristic numbers, also for HPLC analysis, that can be pulled to make a more sophisticated statement about the vanilla origin, but these were not considered in this application [6].

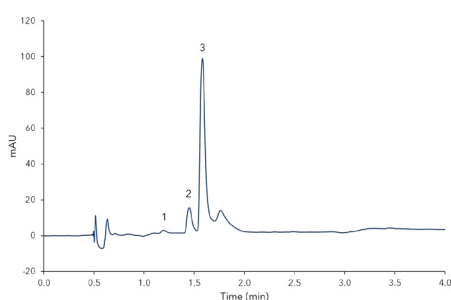
## REFERENCES

- [1] Krishna Veni et al, J Adv Sci Res, 2013, 4(1): 48-51: Analysis of Vanillin In Food Products By High Performance Thin Layer Chromatography
- [2] Jagerdeo et al., Journal of AOAC International Vol. 83, No. 1, 2000 Liquid Chromatographic Determination of Vanillin and Related Aromatic Compounds
- [3] Authenticity of vanilla and vanilla extracts, Elke Anklam, Joint Research Centre European Commission, Environment Institute Food & Drug Unit, 1993, EUR 15561 EN
- [4] Richtlinie für Vanille-Zucker und Vanillin-Zucker (2007) ([link](#))
- [5] Vanille und Vanillearomen, Vanille - die Königin der Gewürze ([link](#))
- [6] Grundlagenpapier der Arbeitsgruppen „Aromastoffe“ und „Stabilisotopenanalytik“ in der Lebensmittelchemischen Gesellschaft zum Thema Herkunft und Authentizität von Vanillearomen ([link](#))

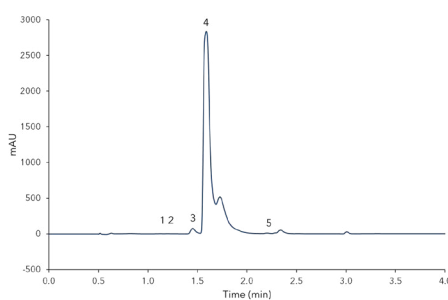
## ADDITIONAL RESULTS

**Tab. A1** Calculated amount of vanilla compounds (in mg/g)

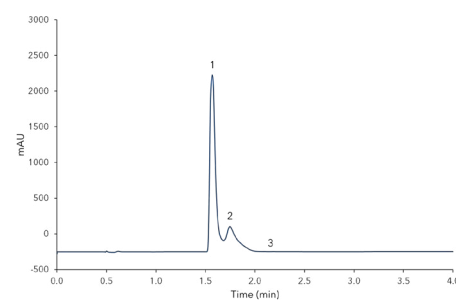
Sample	4-hydroxybenzoic acid	Vanillic acid	4-hydroxybenzaldehyde	Vanillin	Guaiacol	Coumarin	Eugenol
Vanilla bean	0.07	0.104	0.169	3.129	0	0.009	0.007
Bourbon vanilla sugar	0	0	0.015	0.195	0.205	0.003	0.01
Vanillin sugar	0	0	0	8.257	8.704	0.006	0
Vanilla baking aroma	0.017	0.005	0.123	16.533	0	0.019	0.017



**Fig. A1** Chromatogram of bourbon vanilla sugar, 1) vanillic acid, 2) 4-hydroxybenzaldehyde, 3) vanillin



**Fig. A2** Chromatogram of vanilla baking aroma, 1) 4-hydroxybenzoic acid, 2) vanillic acid, 3) 4-hydroxybenzaldehyde, 4) vanillin, 5) coumarin



**Fig. A3** Chromatogram of vanillin sugar, 1) vanillin, 2) guaiacol, 3) coumarin

## ADDITIONAL MATERIALS AND METHODS

**Tab. A2** Method parameters

Column temperature	40° C
Injection volume	1 µL
Injection mode	Partial loop
Detection wavelength	UV 250 nm
Data rate	100 Hz
Time constant	0.01 s

**Tab. A4** Pump parameters

Eluent A	H <sub>2</sub> O <sub>dd</sub> + 0.05 % TFA		
Eluent B	Acetonitrile + 0.1 % TFA		
Flow rate	0.5 mL/min		
Pump program	Time [min]	% A	% B
	0.00	75	25
	0.60	65	35
	2.20	25	75
	2.30	0	100
	3.50	0	100
	3.52	75	25
	8.00	75	25

**Tab. A3** Sample preparation

Vanilla bean	~2 g of crushed vanilla bean was extracted with 4 mL ethanol
Vanillin sugar	1 g of sugar is extracted with 6 mL ethanol
Bourbon vanilla sugar	1 g of sugar is extracted with 4 mL ethanol
Vanilla baking aroma	1 mL (~ 0.83 g) of baking aroma is extracted with 4 mL ethanol

All samples were filtered through a 0.45 µm syringe filter after extraction.

**Tab. A5** System configuration

Instrument	Description	Article No.
Pump	AZURA P 6.1L HPG	<a href="#">APH35GA</a>
Autosampler	AZURA AS 6.1L	<a href="#">AAA10AA</a>
Detector	AZURA MWD 2.1L	<a href="#">ADB01</a>
Flow cell	Standard KNAUER LightGuide UV Flow Cell Cartridge	<a href="#">AMC19XA</a>
Thermostat	AZURA CT 2.1	<a href="#">A05852</a>
Column	Eurospher II 100-2 C18A, 100 x 2 mm ID	<a href="#">10BE184E2F</a>
Software	ClarityChrom 7.4.2 - Workstation autosampler control included	<a href="#">A1670</a>
Software	ClarityChrom 7.4.2 - System suitability extension (SST)	<a href="#">A1677</a>

## RELATED KNAUER APPLICATIONS

[VFD0136N](#) - Comparison of compounds in Bourbon vanilla extract and vanilla flavor

[VFD0073J](#) - Determination of coumarin in cinnamon products



# LC-FLD analysis of 4 PAHs in olive oil samples using AZURA® GPC Cleanup System



Federica Massari\*\*, Juliane Boettcher\*, Kate Monks\*, Pietro Cotugno\*\*, Carlo Zambonin\*\*, applications@knauer.net

\*KNAUER Wissenschaftliche Geräte GmbH, Hegauer Weg 38, 14163 Berlin; www.knauer.net

\*\* Department of Chemistry, University of Bari "Aldo Moro", Via Orabona, 4, 70126 Bari, Italy.

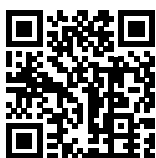
## SUMMARY

The aim of this work is to perform the cleanup of olive oil samples before HPLC analysis by means of the AZURA GPC Cleanup System. The GPC-LC-FLD method is very useful to identify and quantify Benzo(a)pyrene and the sum of four Polycyclic Aromatic Hydrocarbons, PAHs, in olive oils according to Commission Regulation (EU) No 835/2011.

## INTRODUCTION

Polycyclic aromatic hydrocarbons (PAHs) are environmental pollutants, characterized by their hazardous carcinogenic and mutagenic potential [1]. PAHs are ubiquitous compounds, since they can be found not only in all different environmental media (such as air, soil, and water), but also in various foods we encounter in our everyday life [2]. Humans are exposed to PAHs by various pathways. While for smokers the contribution from smoking may be significant, for non-smokers the major route of exposure is the consumption of food, so the dietary intake of PAHs poses the potential health hazards to the public. Food can be

contaminated from environmental sources, industrial food processing and from certain home cooking practices. The presence of PAHs in vegetable oils is generally explained by the combination of many factors and processes including the drying process of the oil seeds (with the combustion of gases), contamination during solvent extraction, packaging material, soil burn [1]. Due to their demonstrated carcinogenic and mutagenic activity, they have been largely investigated. A great effort has been devoted to the improvement of the analytical method to determine such compounds in complex samples, such as food.



# LC-FLD analysis of 4 PAHs in olive oil samples using AZURA® GPC Cleanup System

## RESULTS

To validate the analytical method correlation coefficient  $R^2$ , limit of detection and quantification were calculated. The limits of detection (LODs) and of quantification (LOQs) were calculated by the standard deviation of six calibration solutions at a concentration level equal to the lowest calibration level, an approach does not take into account the matrix effect, on the basis of Regulation (EU) No 836/2011. However they are lower than the limit values namely 2.0  $\mu\text{g}/\text{kg}$  and 10.0  $\mu\text{g}/\text{kg}$  for BaP and PAH4 respectively (Regulation (EU) No 835/2011). The precision of the method was investigated at 0.1  $\mu\text{g}/\text{L}$  (BaA, Chry, BaP), 0.2  $\mu\text{g}/\text{L}$  (BbF) by performing replicate measurements

( $n=3$ ) for 3 days, to estimate the within-day and between-days precision, which was found always lower than 5%. Recoveries were calculated by a spiked olive oil sample (sample 4, organic origin) at concentration levels of 3.3  $\mu\text{g}/\text{L}$  (BbF), 1.6  $\mu\text{g}/\text{L}$  (BaA, Chry, BaP). Good recoveries were obtained for 4 PAHs, according to Regulation (EU) No 836/2011 [5]. All these parameters are listed in (Tab A2 additional results). Fig 1 and Fig 2 show respectively LC-FLD chromatograms of a standard solution and of a spiked purified oil sample. Quantification results of LC-FLD analysis of the selected samples are reported in Tab. 1.

Tab. 1 Quantification results from LC-FLD analysis of four olive oil samples

Analyte	Cal range ( $\mu\text{g}/\text{L}$ )	$R^2$	LOD ( $\mu\text{g}/\text{L}$ )	LOQ ( $\mu\text{g}/\text{L}$ )	RSD %	% recovery mean
Benzo(a)anthracene	0.1 - 10.0	0.9994	0.01	0.04	2.98	100 $\pm$ 3
Chrysene	0.1 - 10.0	0.9995	0.02	0.06	4.13	100 $\pm$ 4
Benzo(b)fluoranthene	0.2 - 20.0	0.9995	0.04	0.13	3.15	60 $\pm$ 5
Benzo(a)pyrene	0.1 - 10.0	0.9989	0.02	0.06	4.63	60 $\pm$ 5

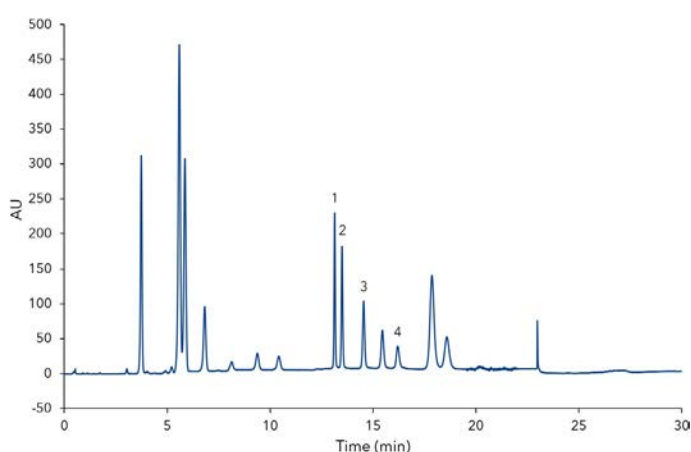


Fig. 1 LC-FLD chromatogram of a standard solution of PAHs at the concentration levels of 5  $\mu\text{g}/\text{L}$  (1) BaA, 2) Chry, 4) BaP) and 10  $\mu\text{g}/\text{L}$  (3) BbF), respectively

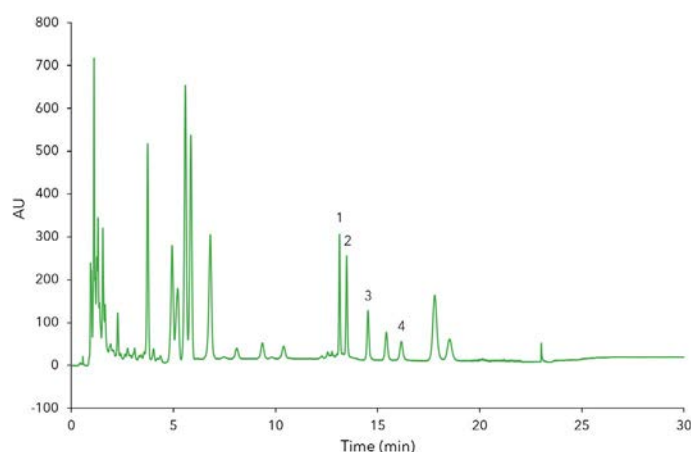


Fig. 2 LC-FLD chromatogram of a spiked and purified oil sample: 1) BaA; 2) Chry; 3) BbF; 4) BaP

## REFERENCES

- [1] Vasudha Bansal, Ki-Hyun Kim. Environment International 84 (2015) 26-38
- [2] Moon, H.B., Kannan, K., Lee, S.J., Ok, G., 2006. Arch. Environ. Contam. Toxicol. 51, 494-502

## MATERIALS AND METHODS

150 mg of each oil sample were diluted with the mobile phase for GPC, Cyclohexane:DCM, 70:30 (v/v), to a volume of 2 mL. Then the mixture was thoroughly mixed using an ultrasonic bath for few seconds. Filtration with a PTFE syringe filter with a pore size of 0.45 µm was necessary before GPC cleanup. After calibrating the system using GPC calibration mixture, the sample cleanup could be performed. 2 mL of each olive oil sample were loaded into the GPC loop with the following procedure: firstly the injection valve was set to load position and the column bypass valve to load position. Secondly, each loop was rinsed with GPC

mobile phase before sample loading and thereafter all tubings were emptied by injecting air with a syringe. Next, the sample was loaded through the injection port and the two sample loop valves were switched to the next position in order to close the loop. The procedure was repeated for each sample and finally the injection valve was set to inject position to start sequence running. Each purified sample is collected by switching of the fractionation valve automatically. After the cleanup, samples were concentrated under nitrogen stream, reconstituted in mobile phase for the HPLC analysis and fluorescence detection.

## CONCLUSION

AZURA® GPC Cleanup system is a useful tool for a fast sample pre-treatment of olive oil samples before LC analysis with fluorescence detection. The GPC clean-up method represents a very important preliminary step for the determination of 4 PAHs recognized for their demonstrated carcinogenic and mutagenic activity. Benzo(a)pyrene was not present in all analyzed samples. Moreover, all analyzed samples show a PAHs content lower than that required from the Reg. 835/2011 as the sum of the four PAHs results to be always lower than 10.0 µg/kg.

## REGULATIONS

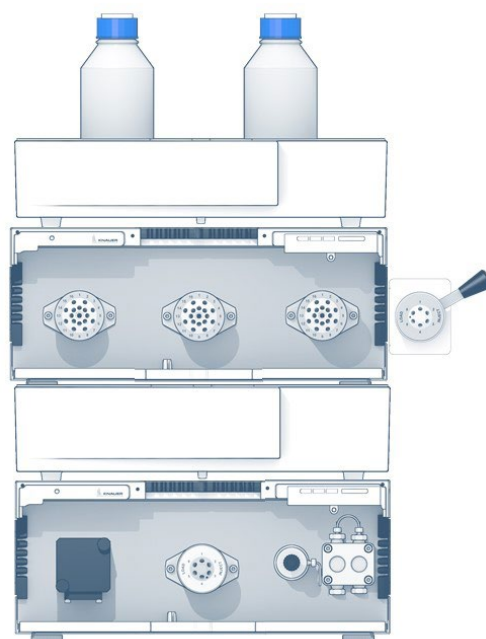
The Scientific Panel on Contaminants in the Food Chain (CONTAM Panel) of EFSA adopted an opinion on Polycyclic Aromatic Hydrocarbons in Food suggesting that benzo(a)pyrene is not a suitable marker for the occurrence of polycyclic aromatic hydrocarbons in food and that a system of four specific substances (PAH4) or eight specific substances (PAH8) would be the most suitable indicator of PAHs in food. Then, Commission Regulation (EU) No 835/2011 of 19 August 2011 amending Regulation (EC) No 1881/2006 required that new maximum levels for the sum of four substances, PAH4 (Benzo(a)pyrene, BaP, Benzo(a)anthracene, BaA, Benzo(b)-fluoranthene, BbF and Chrysene, Chry) should be introduced, whilst maintaining a separate maximum level for benzo(a)pyrene [3, 4]. The maximum levels for Benzo(a)pyrene and PAH4 are respectively 2.0 µg/kg and 10.0 µg/kg in oils and fats (excluding cocoa butter and coconut oil) intended for direct human consumption or use as an ingredient in food. Commission Regulation (EU) No 836/2011 of 19 August 2011 amending Regulation (EC) No 333/2007 established the sampling method and analysis for the official control of the levels of lead, cadmium, mercury, inorganic tin, 3-MCPD and benzo(a)pyrene in foodstuffs [5].

[3] Commission Regulation (EC) No 1881/2006 of 19 December 2006 setting maximum levels for certain contaminants in foodstuffs.

[4] Commission Regulation (EU) No 835/2011 of 19 August 2011 amending Regulation (EC) No 1881/2006 as regards maximum levels for polycyclic aromatic hydrocarbons in foodstuffs.

[5] Commission Regulation (EU) No 836/2011 of 19 August 2011 amending Regulation (EC)

No 333/2007 laying down the methods of sampling and analysis for the official control of the levels of lead, cadmium, mercury, inorganic tin, 3-MCPD and benzo(a)pyrene in foodstuffs.



## ADDITIONAL RESULTS

**Tab. A1** Different analytical parameters for the analytical method according to Regulation (EU) No 836/2011

Parameter	Criterion
LOD	≤ 0.30 µg/kg for each of the four substances
LOQ	≤ 0.90 µg/kg for each of the four substances
Recovery	50 - 120 %

**Tab. A2** R2, LOD and LOQ, RSD %, % recovery mean

Analyte	Concentration (µg/kg)			
	Sample 1	Sample 2	Sample 3	Sample 4
Benzo(a)anthracene	< LOD	2.7	< LOD	< LOD
Chrysene	4.3	6.1	2.3	1.3
Benzo(b)fluoranthene	< LOD	< LOD	< LOD	< LOD
Benzo(a)pyrene	< LOD	< LOD	< LOD	< LOD
PAH4	4.3	8.8	2.3	1.3

## ADDITIONAL MATERIALS AND METHODS

**Tab. A3** GPC Method parameters

Eluent			
Gradient	isocratic		
Flow rate	1 mL/min	System pressure	35 psi
Run temperature	RT	Run time	60 min
Injection volume	2 mL	Injection mode	Full loop
Detection wavelength	254 nm	Data rate	10 Hz
Collect time	18-48 min	Time constant	0.1 sec

**Tab. A5** System configuration & data

Instrument	Description	Article No.
AZURA GPC Cleanup System		<a href="#">771101114</a>
Pump	AZURA P 6.1L	<a href="#">APH35ED</a>
Autosampler	AZURA AS 6.1L	<a href="#">AAA01AA</a>
Detector	AZURA DAD 6.1L	<a href="#">ADC11</a>
Detector	Fluorescence Detector RF-20 A	<a href="#">A59200</a>
Thermostat	AZURA CT 2.1	<a href="#">A05852</a>
Column (GPC)	Glass column 450 mm length x 10 mm ID. Bio-Beads S-X3 resin	
Column (HPLC)	Nucleosil 100-5 C18 PAH, 150 x 4 mm ID with precolumn	<a href="#">15DE420NSJ</a>
Software (GPC)	Mobile Control Chrom with tablet	<a href="#">A9608</a>
Software (HPLC)	ClarityChrom 7.4.1 - Workstation, autosampler control included	<a href="#">A1670</a>

**Tab. A4** HPLC Method parameters and detection settings

Eluent A	Water		
Eluent B	Acetonitrile		
Gradient	Time (min)	% A	% B
	0	40	60
	11	25	75
	12	0	100
	22	0	100
	22.02	40	60
	30	40	60
Flow rate	1.2 mL/min	System pressure	150 bar
Column temperature	20°C	Run time	30 min
Injection volume	10 µL	Injection mode	Partial loop
<b>FLD Detection</b>	<b>Excitation and Emission wavelength settings</b>		
<b>Time</b>	<b>Ex. (nm)</b>	<b>Em. (nm)</b>	
0	270	330	
5.0	270	330	
6.0	250	370	
8.0	330	430	
12.0	270	390	
13.90	370	460	
16.50	290	405	
19.50	246	503	
22.0	270	330	
	Data rate (Hz)	5	
	Time constant	0.1	
UV Detection	Detection (nm)	254	
	Data rate (Hz)	20	
	Time constant (s)	0.05	

## RELATED KNAUER APPLICATIONS

[VFD0152](#) - GPC cleanup of olive oil samples

# Oh so sweet - Quantification of steviol glycosides in stevia samples with RP-HPLC



Johannes Menke<sup>2</sup>, Juliane Böttcher<sup>1</sup>, Kate Monks<sup>1</sup>; applications@knauer.net

<sup>1</sup>KNAUER Wissenschaftliche Geräte GmbH, Hegauer Weg 38, 14163 Berlin; www.knauer.net

<sup>2</sup>Staatliche Technikerschule Berlin, Bochumer Str. 8B, 10555 Berlin

## SUMMARY

Steviol glycosides are the main sweetening compounds in *Stevia rebaudiana* and can be used as natural sugar substitutes. This method provides a fast determination of six steviol glycosides using the AZURA® HPLC Plus System. With a fast separation under 10 min and an optimized gradient, the developed method is suitable for a fast quality control of stevia products. Furthermore, the robustness for this method was validated using DryLab simulation software.

## INTRODUCTION

Steviol glycosides are the main sweetening compounds in *Stevia rebaudiana* which have a far higher sweetening power than normal sucrose or glucose. The sweetness is estimated to be about 400 times higher. Stevia additives have been approved by the EU since 2011 as sweeteners for beverages and food. Good quality Stevia formulates usually do not have the bitter aftertaste as often other sweeteners do. Furthermore, due to their chemical structure they have no known harmful effect on overweight individuals or patients suffering from diabetes, making them an ideal substitute for household sugars. [1] [2]

A method as been developed able to quantify and qualify six of the 12 to 14 steviol glycosides that can be found in stevia plants. The substances determined are rebaudioside A, stevioside, rebaudioside C, dulcoside A, rebaudioside B, and steviolbioside. The method was optimized in terms of temperature and gradient slope using DryLab simulation software. Two different stevia samples were analyzed. Firstly, a sample obtained from dried *Stevia rebaudiana* leaves and secondly a sample obtained from a commonly sold Stevia sweetener.

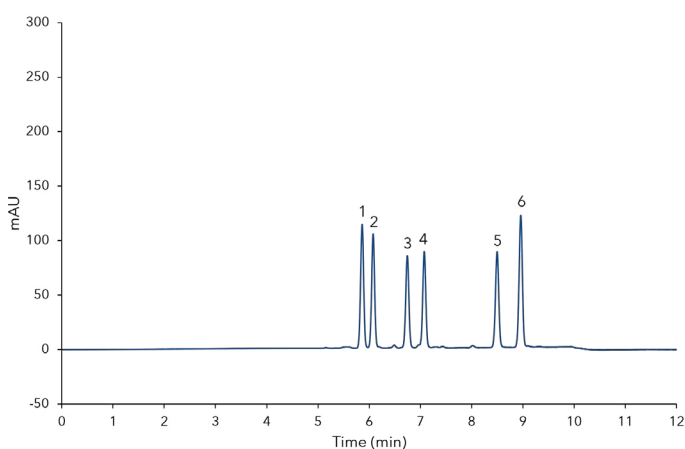


# Oh so sweet – Quantification of steviol glycosides in Stevia samples with RP-HPLC

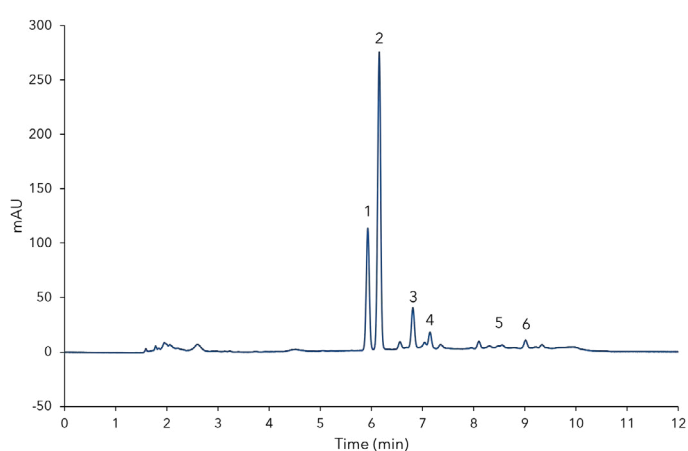
## RESULTS

In **Fig 1** the separation of the mixed standard of six steviol glycosides used for calibration at a level of 0.1 mg/mL for each compound is depicted. The resolution of the critical pair of peaks, namely, rebaudioside A and stevioside was very good and both components were baseline separated. All determined steviol glycosides were baseline separated from each other. The results of the sample measurement are displayed in **Fig 2 and 3**. The quantification of the compounds was achieved with high accuracy and precision. As shown in **Tab A1** (additional results section), several of the calibrated compounds could be determined in both samples. According to the manufacturer of the stevia sweetener it should only contain

rebaudioside A with a mass percentage of 3 %. The measurement shows that this is clearly not the case. Rebaudioside A was determined to be the main component with about 2.4 %, but also stevioside, rebaudioside C, and rebaudioside B were measured. The calculated amounts of steviol glycosides in the analyzed samples are summarized in **Tab A1** (additional results section). Furthermore, 3D-data was recorded showing that no impurities eluted at the same time with the analytes. The recorded continuous spectrum from 200 to 700 nm shows only maxima at the wavelength of 210 nm ensuring clean separation. No trace of sample matrix can be seen.

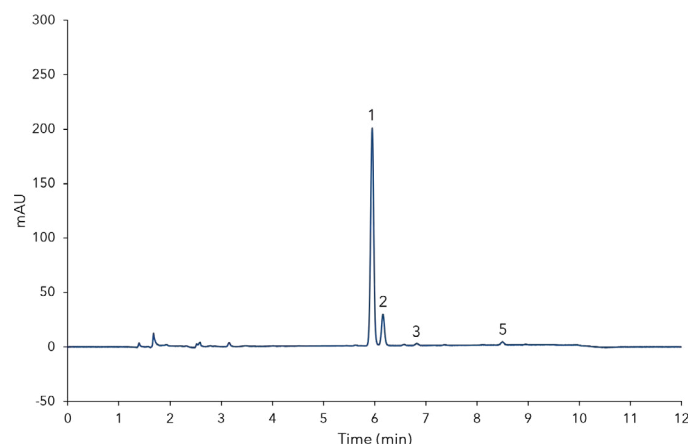


**Fig. 1** Chromatogram of calibration standard at a concentration of 0.1 mg/mL; 1) rebaudioside A, 2) stevioside, 3) rebaudioside C, 4) dulcoside A, 5) rebaudioside B, 6) steviolbioside



**Fig. 2** Chromatogram of dried Stevia leaves sample after SPE purification; 1) rebaudioside A, 2) stevioside, 3) rebaudioside C, 4) dulcoside A, 5) rebaudioside B, 6) steviolbioside

**Fig. 3** Chromatogram of Stevia sweetener sample; 1) rebaudioside A, 2) stevioside, 3) rebaudioside C, 4) dulcoside A, 5) rebaudioside B, 6) steviolbioside



## MATERIALS AND METHODS

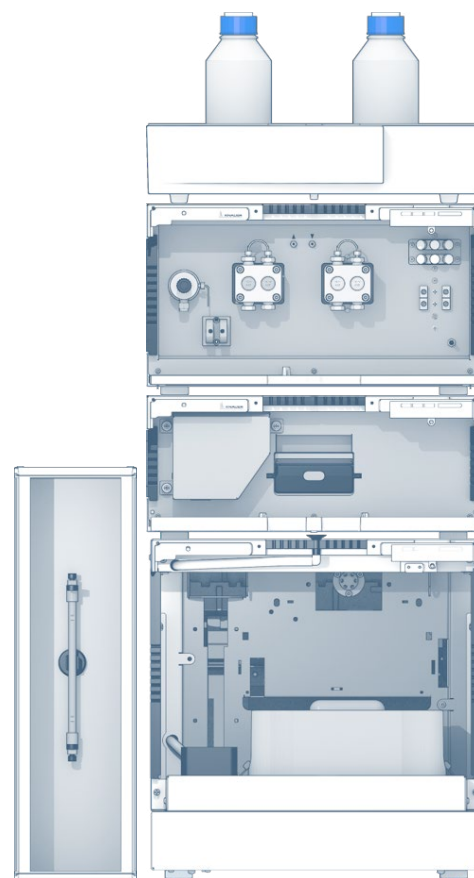
The determination of steviol glycosides was performed on a KNAUER AZURA HPLC Plus System equipped with an autosampler AZURA AS 6.1L, a binary high-pressure gradient pump AZURA P 6.1L with 10 mL pump head, an AZURA CT 2.1L column thermostat, and a diode array detector AZURA DAD 2.1L. The eluent was a composition of A: water and B: acetonitrile. A step gradient at a flow rate of 1.2 mL/min was used with a total run time of 12 minutes including equilibration time. The column temperature was set to 40 °C. Detection was carried out at 210 nm and additionally the spectrum was recorded in a range from 200 nm to 700 nm. The column used here had the dimensions 250 x 4.6 mm ID with precolumn was filled with Eurospher II 100-5 C18 silica. Injection volume was 20 µL for samples and standard solutions.

## CONCLUSION

The quantification of the compounds was achieved with high accuracy and precision again showing the robustness of this method. This method provides a fast and robust analysis for food samples containing steviol glycosides with a runtime of only 12 min per sample. Furthermore, with the optimized gradient and column temperature a baseline separation of the otherwise similarly eluting rebaudioside A and stevioside is achievable. The SPE sample preparation will diminish the matrix of plant extracts to a very low level preventing disturbances during sample analysis, which results in lower detection limits.

## REFERENCES

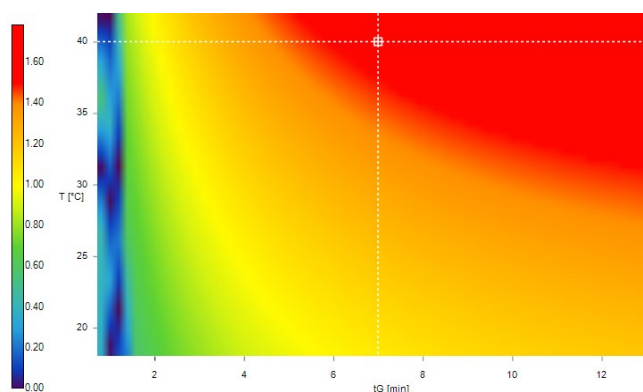
- [1] Steviolglycoside in Süßwaren Entwicklung und Validierung einer Analysenmethode mittels HPLC-UV. Teresa Brandes. Marion Raters and Reinhard Matissek. DLR. 2013 literature\steviolglycoside-in-suesswaren-dlr.pdf
- [2] Application Note - Fast online SPE purification of Stevia plant extracts. René Borstel. 2011 literature\vfd0093n\_online\_spe\_of\_steviol\_glycosides.pdf
- [3] Reversed-Phase HPLC Analysis of Steviol Glycosides Isolated from Stevia rebaudiana Bertoni. Venkata Sai Prakash Chaturvedula and Julian Zamora. Food and Nutrition Sciences. 2014. 5. 1711-1716 literature\Stevia\_RP.pdf



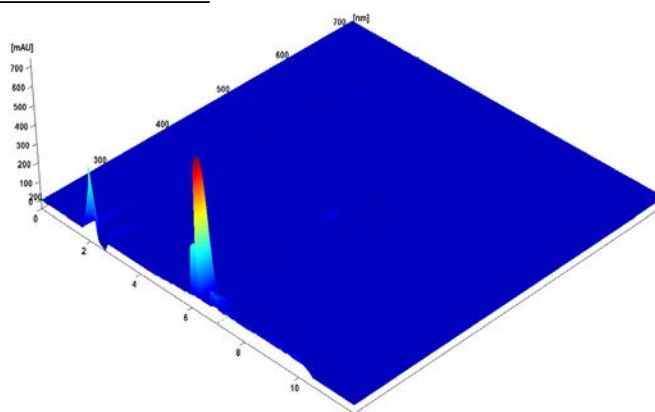
## ADDITIONAL RESULTS

Compound	Dried Stevia leaves			Stevia sweetener		
	Average amount (mg/mL)	Mass fraction w (mg/g)	Yield y (%)	Average amount (mg/mL)	Mass fraction w (mg/g)	Yield y (%)
Rebaudioside A	0.099	9.900	0.99	0.724	24.133	2.413
Stevioside	0.265	26.500	2.65	0.114	3.789	0.379
Rebaudioside C	0.045	4.500	0.45	0.002	0.056	0.006
Dulcoside A	0.014	1.400	0.14	-	-	-
Rebaudioside B	0.003	0.300	0.03	0.009	0.289	0.029
Steviolbioside	0.008	0.800	0.08	-	-	-

**Tab.A1** Average amount, mass fraction and yield for dried stevia leaves and stevia sweetener samples



**Fig.A1** Resolution map for optimized working point; red = good resolution, blue = poor resolution (Molnar Institute DryLab Version 4.3.1.1)



**Fig.A2** Acquired PDA 3D Data for Dried Stevia Leaves sample (200 - 700 nm)

## ADDITIONAL MATERIALS AND METHODS

**Sample extraction:** 1 g of dried Stevia rebaudiana leaves were extracted with 25 mL distilled water at 60 °C and sonicated in an ultrasonic bath for 10 min following 30 min of extraction at 60 °C in a water bath. The mixture was centrifuged at 10,000 xg for 20 min at room temperature. The supernatant was transferred to a volumetric flask and the pellet was extracted two more times. The volume was adjusted with water to 100 mL. The extract was then filtered using 0.45 µm hydrophilic filter. 300 mg of common stevia sweetener powder were dissolved in 10 mL distilled water and then a Iso filtered using a 0.45 µm hydrophilic filter. The solution was diluted 1:4 with water before analysis.

**Solid phase extraction:** The dried Stevia leaves extract was further purified using SPE-cartridges filled with 500 mg Eurospher II 100-20/45 µm C18

**Tab.A2** Method parameters

Eluent A	$\text{d}_d\text{H}_2\text{O}$		
Eluent B	Acetonitrile		
Gradient	Time [min]	% A	% B
	0.00	70	30
	1.00	70	30
	8.00	55	45
	8.02	70	30
12.00	70	30	
Flow rate	1.2 mL/min	System pressure	~150 bar
Run temperature	40 °C	Run time	12 min
Injection volume	20 µL	Injection mode	Full loop
Detection wavelength	210 nm	Data rate	20 Hz
		Time constant	0.05 s

material. The cartridge volume (CV) was 3 mL. It was conditioned with 3 CV methanol and then washed with 1 CV water using a vacuum chamber. 2 mL of stevia extract were applied using gravitational force only. The cartridge was washed with 1 CV water and afterwards with 5 mL of 20:80 acetonitrile:water (v/v). For elution 2 mL acetonitrile:water 30:70 (v/v) was used.

**Simulation:** Parameters temperature (T) and gradient slope (tG) were optimized using DryLab simulation software. Corner stones of the simulation were four experiments: (1) T=40 °C, tG=30 min; (2) T=40 °C, tG=10 min; (3) T=20 °C, tG=30 min; (4) T=20 °C, tG=10 min. As sample calibration standard Level 4 was used.

**Tab.A3** System configuration & data

Instrument	Description	Article No.
Pump	AZURA P6.1L. HPG	<a href="#">APH35GA</a>
Autosampler	AZURA AS 6.1L	<a href="#">AAA00AA</a>
Detector	AZURA DAD 2.1L	<a href="#">ADC01</a>
Flow cell	LightGuide UV Flow Cell Cartridge 10mm, 2µL, 50bar	<a href="#">AMC19XA</a>
Column thermostat	AZURA CT 2.1	<a href="#">A05852</a>
Colum	Vertex Plus Column. Eurospher II 100-5 C18, 250 x 4.6 mm ID with precolumn	<a href="#">25VE181E2J</a>
Software	ClarityChrom 7.4.2 - Workstation.	<a href="#">A1670</a>
	autosampler control included ClarityChrom 7.4.2 - PDA extension	<a href="#">A1676</a>



# Determination of sugars in honey – comparison of refractive index and light scattering detection



Juliane Böttcher, Kate Monks; [applications@knauer.net](mailto:applications@knauer.net)

KNAUER Wissenschaftliche Geräte GmbH, Hegauer Weg 38, 14163 Berlin; [www.knauer.net](http://www.knauer.net)

## SUMMARY

Determination of the sugar content and their composition in honey allows a prediction about the origin of honey and determines how it should be labelled. Because of honey being one of the most popular natural food stuffs and its growing consumption, it is necessary to carry out quality control. Here, the dedicated AZURA® Sugar Analytical System with autosampler upgrade was used for the analysis of sugar in honey. Moreover, refractive index and light scattering detection for this application were compared.

## INTRODUCTION

There are well over 50 different kinds of honey on the market, which differ in consistency, colour, and taste. In Germany, the honey ordinance differentiates honey according to the origin, type of extraction, the form of supply or the intended use. Natural bee honey consists of approx. 39 % fructose and approx. 34 % glucose. [1] For example, blossom honey (Blütenhonig) must contain at least 60 % fructose and glucose [2]. In addition, small amounts of sucrose or maltose can be detected [1]. Internationally, products containing more than 5 % sucrose or maltose must no longer be labeled as „pure“ honey [3]. The Association of Official

Analytical Chemist (AOAC) designed a method for the analysis of sucrose, fructose, and glucose in honey (AOAC 977.20). The method is originally performed in HILIC mode, here a KNAUER Eurokat Pb polymer column was used. Since KNAUER has produced its own honey from a bee colony located in the garden, this honey was taken as one of the samples. Furthermore, one commercially available honey and agave nectar were analysed. This application is also used to illustrate the difference between the detection with the AZURA RID 2.1L and the SEDEX LT100 ELSD.



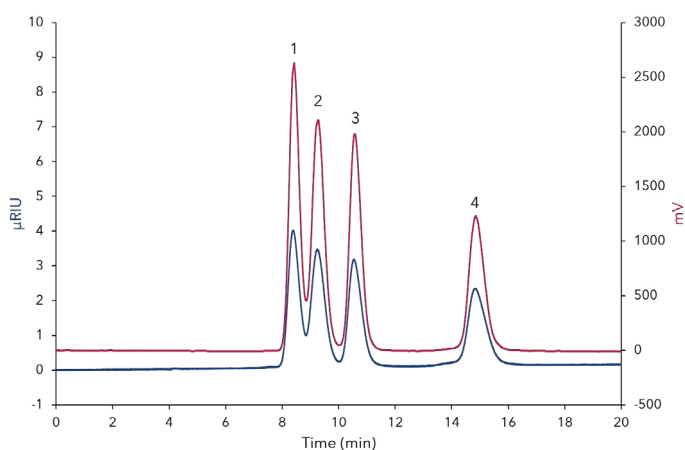
Additional Information

# Determination of sugars in honey – comparison of refractive index and light scattering detection

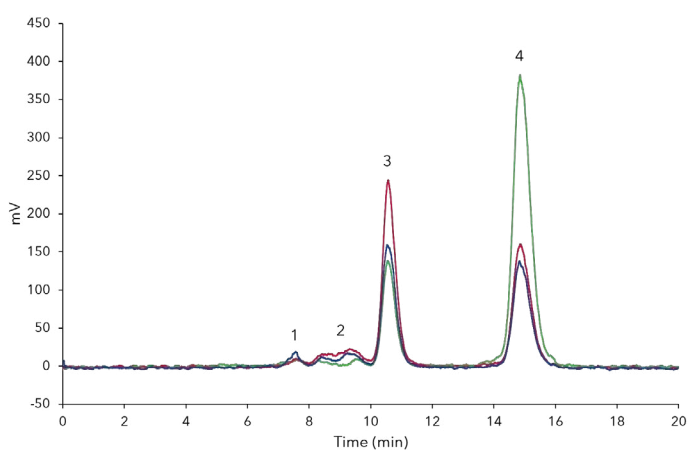
## RESULTS

The most important carbohydrates for the evaluation of honey: fructose, glucose, sucrose, and maltose were determined here. Sucrose and maltose were not baseline separated but the resolution was good enough to clearly identify and quantify them. A calibration in a range from 0.03 mg/mL to 1.50 mg/mL for the ELSD and from 0.30 mg/mL to 3.00 mg/mL for the RID was prepared. **Fig 1** shows the traces of a mixed standard at a level of 0.6 mg/mL for both detectors. **Fig 2 and 3** show an overlay of the three different samples measured with ELSD and RID. The KNAUER honey and the fruit blossom honey showed a similar profile. Both

contain more fructose than glucose. Residues of maltose and sucrose were detected. The agave nectar contains more fructose. In comparison its fructose amount is about 1.3 times higher than measured for the honey samples. **Tab A1** (additional results section) summarizes the calculated results for all samples. Calculated results of both detectors are similar. The deviation of certain values might occur due to different calibration functions and different sensitivities of the detectors. The total sugar content (averaged value from both detectors) of the KNAUER honey and fruit blossom honey was around 77% and 73%, respectively.

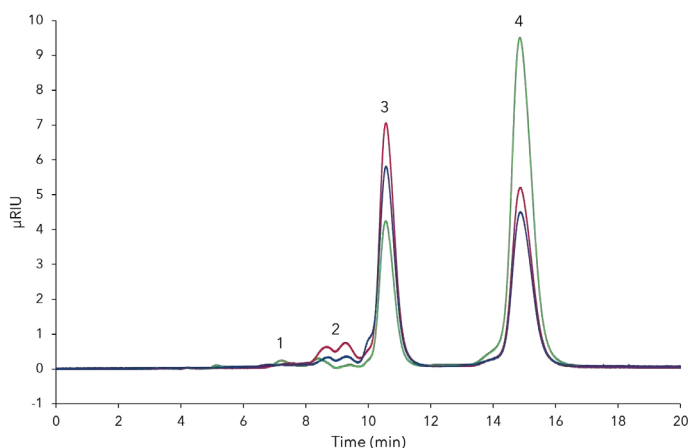


**Fig. 1** ELSD trace (red) and RID trace (blue) of a mixed standard at 0.60 mg/mL; 1) sucrose, 2) maltose, 3) glucose, 4) fructose



**Fig. 2** Overlay of measured samples; ELSD traces: Knauer honey - blue, blossom honey - red, agave nectar - green; 1) sucrose, 2) maltose, 3) glucose, 4) fructose

**Fig. 3** Overlay of measured samples; RID traces: Knauer honey - blue, blossom honey - red, agave nectar - green; 1) sucrose, 2) maltose, 3) glucose, 4) fructose



## MATERIALS AND METHODS

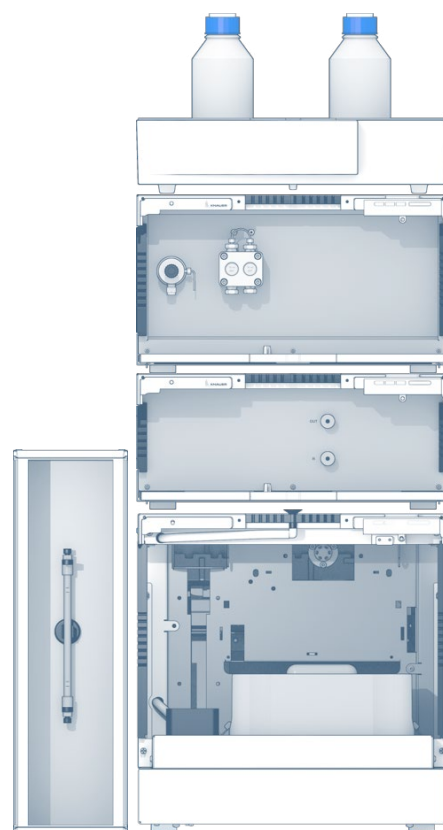
The AZURA® dedicated system for sugar analytics with an additional autosampler was used for this application. The system consisted of an isocratic AZURA P 6.1L pump, an AZURA AS 6.1L autosampler, an AZURA CT 2.1 column thermostat, and an AZURA RID 2.1L refractive index detector. For the comparison also a SEDEX LT100 ELSD was used. The isocratic method ran at a flow rate of 0.8 mL/min at a column temperature of 75 °C. Water was used as eluent. Detector settings of the RID 2.1L were set to 20 Hz. Nitrogen pressure of ELSD was 3.5 bar. Eluent goes through the nebulizer with a temperature of 65 °C, the filter was set to 10 s and the gain was dynamic. The samples were weighed, and 10 mL of water were added. Before injection a further dilution with water in a ratio 1:100 (ELSD) and 1:10 (RID) was carried out.

## REFERENCES

- [1] AID Zucker, Sirupe, Honig, Zuckeraustauschstoffe und Süßstoffe (Nr. 1157)
- [2] Honigverordnung vom 16. Januar 2004 (BGBl I S. 92)
- [3] Codex Alimentarius Commission, 2001; GB18796-2005, 2005

## CONCLUSION

Obviously, the ELSD provides a much higher sensitivity. A concentration of 0.03 mg/mL was also measured with the RID, but the peaks were too low in comparison to the ELSD and could therefore not be considered for calibration. Chromatograms of this concentration are displayed in the additional results section. The advantage of the RID 2.1L lies in its high linear range up to 1000 µRIU or more when using the extended dynamic range. It was no problem here to inject the undiluted samples but due to the chosen calibration range a dilution was necessary. The honey samples contained more than 60% fructose and glucose, as expected. The ratio of fructose and glucose was also typical for honey. The more glucose a honey has, the faster it tends to crystallize. The agave nectar showed a different kind of sugar pattern. [1] No matter which detector is chosen, besides the determination of sugars, this application can also be used to differentiate between natural products such as honey and possible substitutes.



## ADDITIONAL RESULTS

Tab. A1 Calculated amounts of sugar in samples

Detection	Sample	Description	Fructose (g/100 g)	Glucose (g/100 g)	Sucrose (g/100 g)	Maltose (g/100 g)	Sugar content (%)
ELSD	1	KNAUER honey	38.20	29.80	2.81	4.16	74.98
ELSD	2	fruit blossom honey	34.07	31.38	1.60	2.41	69.46
ELSD	3	agave nectar	51.34	15.57	0.82	0.94	68.68
RID	1	KNAUER honey	39.20	38.81	not detected	1.57	79.57
RID	2	fruit blossom honey	38.37	35.42	not detected	1.9	75.69
RID	3	agave nectar	52.04	16.3	1.14	0.78	70.25

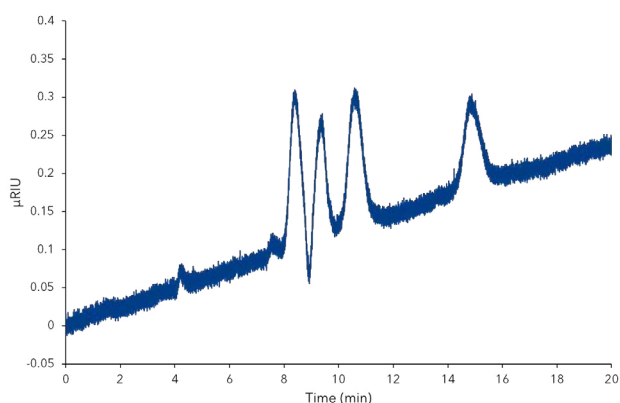


Fig. A1 RID trace of mixed standard at 0.03 mg/mL

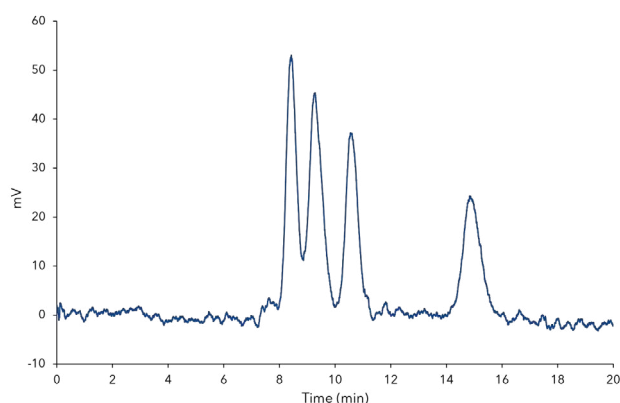


Fig. A2 ELSD trace of mixed standard at 0.03 mg/mL

## ADDITIONAL MATERIALS AND METHODS

Tab. A2 Method parameters

Eluent A	$\text{H}_2\text{O}$		
Gradient	isocratic		
Flow rate	0.8 mL/min	System pressure	~55 bar
Run temperature	75°C	Run time	20-25 min
Injection volume	20 $\mu\text{L}$	Injection mode	Full loop
Detection wavelength	RID	Data rate	20 Hz
		Time constant	0.05 s
Detection	ELSD	Temperature	65°C
		Filter	10 s
		Gain	Dynamic
		Nitrogen pressure	3.5 bar

Tab. A3 System configuration

Instrument	Description	Article No.
Pump	AZURA P6.1L, isocratic	<a href="#">APH30EA</a>
Autosampler	AZURA AS 6.1L	<a href="#">AAA10AA</a>
Detector	AZURA RID 2.1L	<a href="#">ADD31</a>
Detector	Light Scattering Detector Sedex 100LT	<a href="#">A0754-6</a>
Column thermostat	AZURA CT 2.1	<a href="#">A05852</a>
Column	Vertex Plus Column, Eurokat Pb, 10 $\mu\text{m}$ , 300 x 8 mm ID Vertex Plus Column, Eurokat Pb, 10 $\mu\text{m}$ , 30 x 8 mm ID	<a href="#">30GX350EKN</a> <a href="#">03GX350EKN</a>
Software	ClarityChrom 7.4.2 - Workstation, auto-sampler control included	<a href="#">A1670</a>

## RELATED KNAUER APPLICATIONS

[VFD0160](#) - Determination of sugars and natural sugar substitutes in different matrices

[VFD0161](#) - Determination of sugars in honey using HILIC separation and RI detection

[VFD0155](#) - Semi preparative xylitol purification with dedicated sugar purification system

[VSP0013](#) - Simplified scale up for sugars with the AZURA RID 2.1L extended dynamic range option

# Scale-up of an analytical HPLC method for steviol glycosides to a preparative approach

Johannes Menke, Yannick Krauke, Kate Monks; applications@knauer.net  
KNAUER Wissenschaftliche Geräte GmbH, Hegauer Weg 38, 14163 Berlin – www.knauer.net



## SUMMARY

Steviol glycosides are the main sweetening compounds in *Stevia rebaudiana* and can be used as natural sugar substitutes due to their far higher sweetening power than normal sucrose or glucose. The sweetness is estimated to be about 400 times higher. This application describes an easy transfer of an existing analytical HPLC method to a preparative HPLC using overload experiments together with the KNAUER Scale-Up converter. Furthermore, this approach of scale-up is also applicable for different analytes and thus provides a fast scale-up.

## INTRODUCTION

For several years research has been undertaken to find sugar substitutes that are calorie free but have the same taste and properties as classic sugar, for diabetics and as part of a calorie-controlled diet. One popular substitute is the so-called “Stevia” which is a mixture of steviol glycosides isolated from the plant *stevia rebaudiana* [1]. The steviol glycoside rebaudioside A is the main compound of interest as it is the

sweetest and less bitter compound of the extract. Often a mixture of rebaudioside A and stevioside is found in the “Stevia” products.

The development of a purification method with high yield of rebaudioside A, few stevioside impurities, and a high throughput would increase the economic output of stevia production.



# Scale-up of an analytical HPLC method for steviol glycosides to a preparative approach

## RESULTS

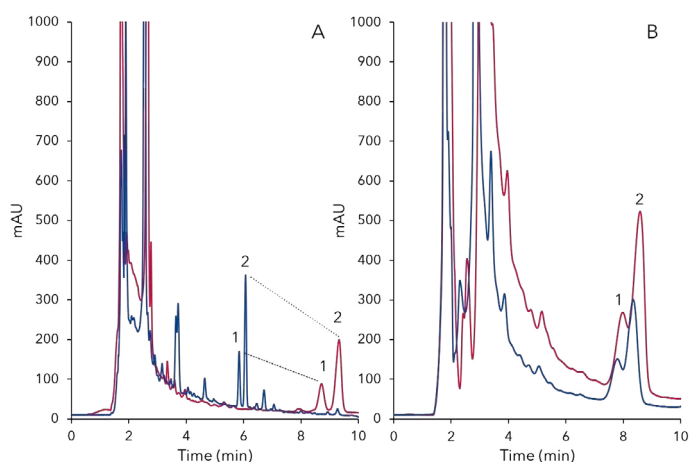
In analytical scale an isocratic method was developed for the purification of rebaudioside A and stevioside from stevia leaves. The previously described gradient method (application note VFD0168) was transferred to isocratic mode using the DryLab (Molnár-Institute, Germany) software. The isocratic method derived from the simulation was further developed for the gradient method. A concentration of 30:70 acetonitrile:water (v/v) showed the best performance (data not shown). A mix-standard of rebaudioside A, stevioside, rebaudioside C, dulcoside A, rebaudioside B, and steviolbioside with individual concentrations of 0.1 mg/mL was used as sample. Comparison of the gradient and isocratic method showed, that the two target peaks (rebaudioside A and stevioside) were nearly baseline separated but eluted later and were broader (Fig. 1A, 1 and 2). Hence, this isocratic method was transferred to an analytical column with 10  $\mu\text{m}$  particles. This

was done to ease the scale up to the preparative scale with a column with the same material.

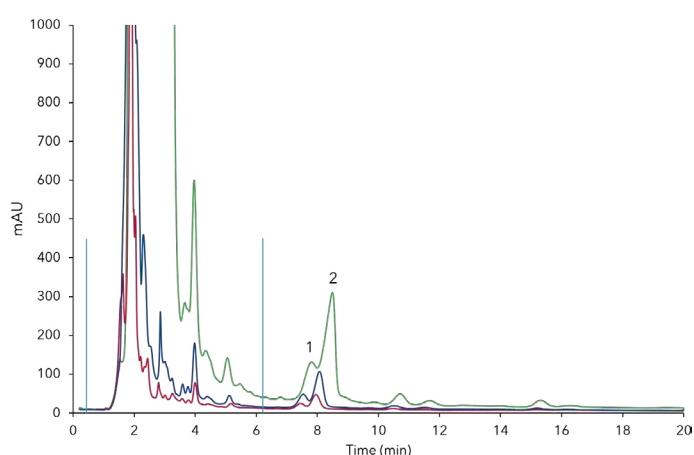
Overload experiments in the analytical scale showed that 100  $\mu\text{L}$  and 200  $\mu\text{L}$  injection volume lead to overlapping of the two main peaks (Fig. 1B). Stevia extract obtained from dried stevia leaves was used for the experiments, both analytical and preparative scale.

The method was scaled up with the KNAUER ScaleUp Converter from the original ID 4.6 mm to an ID 20 mm column maintaining the length of 250 mm and thus keeping the HETP constant. The flow rate was increased from 1.2 mL/min to 22 mL/min.

Injections of up to 2 mL sample still showed a minimal separation of both peaks (Fig. 2). The matrix peak (1-5 min) increased significantly (Fig. 2, blue bars).



**Fig. 1** A - Transfer gradient to isocratic method; 1) rebaudioside A, 2) stevioside; isocratic 30:70 acetonitrile/H<sub>2</sub>O, 20  $\mu\text{L}$  injections, C18, 5  $\mu\text{m}$  particle, 1.2 mL/min, 30°C B - Overlay chromatograms 100  $\mu\text{L}$  (blue) and 200  $\mu\text{L}$  (red) sample injection on analytical 10  $\mu\text{m}$  particle column; 1) rebaudioside A, 2) stevioside; 30:70 acetonitrile/H<sub>2</sub>O, C18, 1.2 mL/min, 30°C



**Fig. 2** Overload experiments on preparative column, 200  $\mu\text{L}$  (red), 500  $\mu\text{L}$  (blue), 2000  $\mu\text{L}$  (green); 1) rebaudioside A, 2) stevioside, blue bars - matrix, 25°C, 22 ml/min

## REFERENCES

- [4] "Stevia Leaf to Stevia Sweetener: Exploring Its Science, Benefits, and Future Potential" P. Samuel, K. T. Ayoob, B. A. Magnuson, et al. J Nutr, Volume 148, Issue 7, 1 July 2018, Pages 1186S-1205S.
- [5] KNAUER scale up converter ([link](#))

## MATERIALS AND METHODS

The AZURA HPLC Plus System was used for analysis as described in application note [VFD0168](#). A composition of A: water and B: acetonitrile was used as eluent. For the method transfer from gradient mode to isocratic a Vertex Plus column filled with Eurospher II 100-10 C18 silica in a dimension 250 x 4.6 mm ID with precolumn was used. The flow was set to 1.2 mL/min. The scale-up was calculated using the KNAUER ScaleUp Converter [2] ([Fig A1](#)).

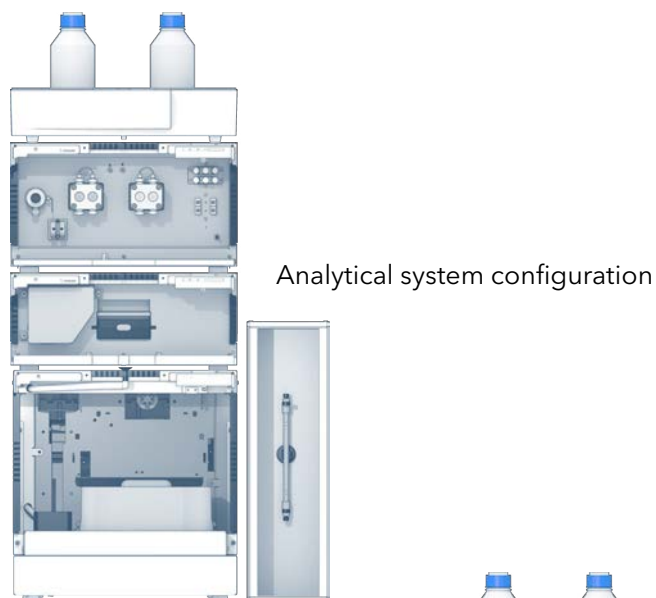
The AZURA Preparative HPLC system consisted of AZURA P 2.1L 100 mL sst pump with ternary LPG

module, AZURA UVD 2.1L detector with 3 mm, 2  $\mu$ l flow cell, an AZURA assistant module with a 12 port multi position 1/8" sst valve (solvent selection), a 6 port 2 position 1/16" sst injection valve, a P 4.1S 50 ml sst feed pump and a Labocol vario-4000 fraction collector. For the method transfer from analytical to preparative scale a KNAUER Vertex Plus AX column, Eurospher II 100-10 C18, 250 x 20 mm ID was used. The flow was scaled to a rate of 22 mL/min. Peaks were fractionated using 3 mL fractions and analyzed using an analytical HPLC as described in application note [VFD0168](#).

## CONCLUSION

Using simulation software provided a quick transfer from gradient elution to an isocratic method which could be established using the later preparative column material but in analytical column dimensions. In the following a fast method-transfer from an analytical to a preparative HPLC approach could be achieved using the KNAUER ScaleUp Converter. The isocratic HPLC method was successfully transferred to a preparative scale while keeping the elution characteristics of the target analytes rebaudioside A and stevioside. The overload experiments also showed a maximum column loading capacity both analytical and preparative. Thus, for following experiments an easy estimate concerning sample load is possible. In addition, the overload experiments depict the need for matrix reduction, as the matrix signal is close to overlay the target signal if not being decreased.

Concluding the derived preparative method was well suited as a starting point for follow up experiments as described in application note [VFD0171](#).



## ADDITIONAL RESULTS

The screenshot shows the 'Methods | Splitter | Chromatograms' window. It is divided into two main sections: 'Column 1' and 'Column 2'. Each section has 'Column Parameters' and 'Method Settings'.

**Column 1 Parameters:** Column Length: 250.0 mm, Column ID: 4.6 mm, Particle Size: 10.0 µm.

**Column 2 Parameters:** Column Length: 250.0 mm, Column ID: 20.0 mm, Particle Size: 10.0 µm.

**Method Settings (Column 1):** Flow Rate: 1.20 ml/min, Injection Volume: 200.0 µl, Mass load scaling: 50.0 mg, Run Time: 20.00 min, Column Void Volume: 2.82 ml.

**Method Settings (Column 2):** Flow Rate: 22.68 ml/min, Injection Volume: 3780.7 µl, Mass load scaling: 945.2 mg, Run Time: 20.00 min, Column Void Volume: 53.38 ml.

Both sections have a 'Gradient' section set to 'No Gradient'.

Fig. A1 Linear scale up with KNAUER Scale-up converter

## ADDITIONAL MATERIALS AND METHODS

Tab. A1 Sample preparation

For the analytical experiments 1 g of dried stevia leaves were extracted in water as described in application note VFD0168.

A highly concentrated sample of stevia extract was prepared for the preparative experiments. 15g of dried stevia leaves were extracted in 200 mL water, prepared as described in application note VFD0168 and adjusted to a final volume of 250 mL. Additional centrifugation steps were necessary to remove particles from the solution before and after filtration.

Tab. A2 Method parameters

	Analytical	Preparative
<b>Column temperature</b>	30 °C	RT
<b>Injection volume</b>	50 µL; 100 µL; 200 µL	500 µL; 1000 µL; 2000 µL
<b>Injection mode</b>	Full loop / Partial loop	Full loop
<b>Detection wavelength</b>	UV 210 nm	UV 210 nm
<b>Data rate</b>	20 Hz	2 Hz

Tab. A3 Pump parameters (analytical)

<b>Eluent A</b>	ACN:H <sub>2</sub> O 30:70 (v/v)
<b>Flow rate</b>	1.2 mL/min
<b>Pump program</b>	isocratic 30% B

Tab. A4 Pump parameters (preparative)

<b>Eluent A</b>	ACN:H <sub>2</sub> O 30:70 (v/v)
<b>Flow rate</b>	22 mL/min
<b>Pump program</b>	isocratic

Tab. A5 System configuration

Instrument	Description	Article No.
<b>Pump 1</b>	AZURA P 2.1L, 100 mL, sst	<a href="#">APE20KA</a>
<b>Pump 2</b>	AZURA LPG ternary module for Pump P 2.1L	<a href="#">AZZ00AB</a>
<b>Detector</b>	AZURA UVD 2.1L	<a href="#">APH30EA</a>
<b>Flow cell</b>	3 µl; 1/16"	
<b>Assistant</b>	AZURA ASM 2.1L Left: 12 Mpos, 1/8", sst Middle: 6 Port 2Pos, 1/16", sst Right: P4.1S, 50 mL, sst	<a href="#">AYEKEABR</a>
<b>Fraction collector</b>	Labocol Vario-4000	<a href="#">A591022</a>
<b>Column</b>	KNAUER Vertex Plus AX Eurospher II 100-10 C18, 250 x 20 mm ID	<a href="#">25PE181E2N</a>
<b>Software</b>	PurityChrom5 Basic KNAUER ScaleUp Converter	<a href="#">A2650</a> <a href="#">A1696</a>

## RELATED KNAUER APPLICATIONS

[VFD0168](#) - Oh so sweet - Quantification of steviol glycosides in Stevia samples with RP-HPLC

[VFD0171](#) - Advantages of preparative online SPE compared to batch LC for stevia purification

[VFD0174](#) - Determination of six steviol glycosides using reversed phased HPLC and online SPE



# Advantages of preparative online SPE compared to batch LC for stevia purification



Johannes Menke<sup>2</sup>, Yannick Krauke<sup>1</sup>, Juliane Böttcher<sup>1</sup>, Corinna Lippmann<sup>2</sup>, Kate Monks<sup>1</sup>; applications@knauer.net

<sup>1</sup>KNAUER Wissenschaftliche Geräte GmbH, Hegauer Weg 38, 14163 Berlin; www.knauer.net

<sup>2</sup>Staatliche Technikerschule Berlin, Bochumer Str. 8B, 10555 Berlin

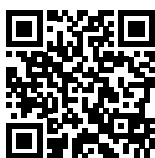
## SUMMARY

Steviol glycosides are the main sweetening compounds in *Stevia rebaudiana*. Due to their up to 400 times higher sweetening power compared to sucrose or glucose they are often used as natural sugar substitutes. To enable a commercial usage, the plant extracts need to be purified. In this work preparative online SPE (solid phase extraction) was investigated for improvement of overall purity due to reduction of matrix contamination.

## INTRODUCTION

For several years research has been undertaken to find sugar substitutes that are calorie-free but have the same taste and properties as classic sugar. Such substitutes are important especially in diets necessary for diabetics and increasingly as part of the so-called "low-carb" movement. One popular substitute is "Stevia" which is a mixture of steviol glycosides isolated from the plant *Stevia rebaudiana* [1]. The steviol

glycoside rebaudioside A is the main compound of interest as it is the sweetest and less bitter compound of the extract. Often Stevia products contain a mixture of rebaudioside A and stevioside. The development of a purification method with high yield of rebaudioside A, only few stevioside impurities, and high throughput would increase the economic output of Stevia production.

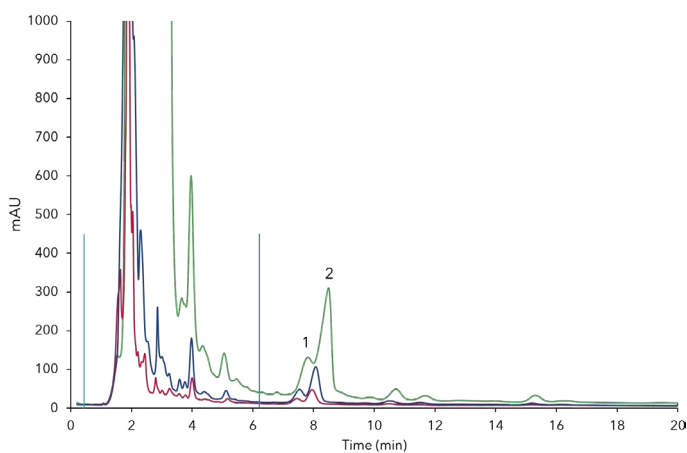


# Advantages of preparative online SPE compared to batch LC for stevia purification

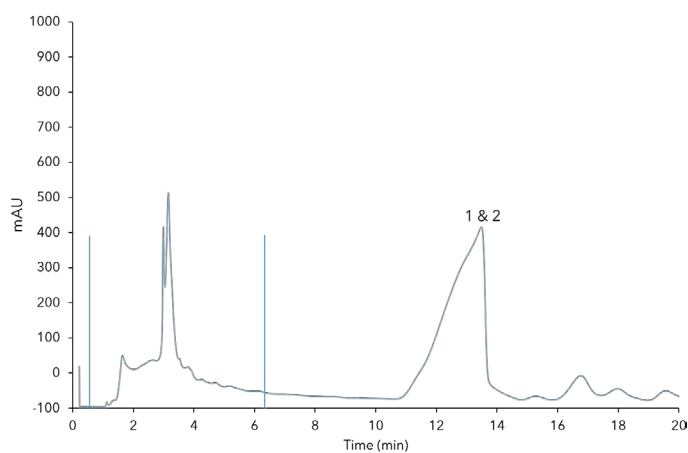
## RESULTS

For purification of rebaudioside A and stevioside from stevia leaves a gradient method for analysis of stevio glycosides was transferred to an isocratic method (VFD0170). The final method was up-scaled with the KNAUER up-scale converter [2] to an ID 20 mm column of same length as the analytical column, increasing the flow rate from 1.2 mL/min to 22 mL/min. Sample injections of up to 2 mL still showed a slight separation of the rebaudioside A and stevioside peaks (Fig 1). The matrix peak (1-5 min) increased significantly (Fig 1, blue). Large sample matrix can negatively affect the separation abilities and wear off the main column therefore elimination of matrix prior to the purification is desirable. An online-SPE method was developed with a short preparative column in front of the main

column. 10 mL of sample were loaded, the matrix washed away and then the target compounds were injected on the main column (Fig 2). Comparison of the chromatograms of the classical batch process (Fig 1) and the online-SPE process (Fig 2) showed that the automated SPE process significantly decreased the matrix. The fraction analysis revealed that only a small part of the overlapping peak contained nearly pure rebaudioside A; fractions 3-5 approx. 15 mL with >90 % rebaudioside A and <10 % stevioside (Fig 3, B). The later fractions contained high amounts of stevioside but also still rebaudioside A (Fig 3, C). The results showed that purification of highly pure rebaudioside A is possible by introducing an additional online-SPE step, however yield is sacrificed.

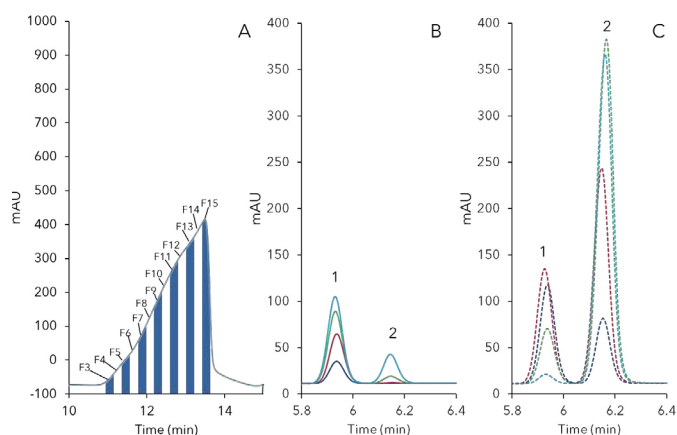


**Fig. 1** Overload experiments on preparative column, 200 µL (red), 500 µL (blue), 2000µL (green); 1) rebaudioside A, 2) stevioside, blue bars - matrix, 25°C, 22 ml/min



**Fig. 2** Preparative online SPE, 10 mL loading; 1) rebaudioside A, 2) stevioside, blue bars - matrix, 25°C, 22 mL/min

**Fig. 3** Fraction analysis of preparative online-SPE purification (Fig 2) of rebaudioside A (1) and stevioside (2); A) fractionation of target peak, 5 mL fractions B) F3 (blue), F4 (red), F5 (green), F6 (light blue); C) F7 (red dashed), F10 (blue dashed), F12 (green dashed), F15 (light blue dashed)



## MATERIALS AND METHODS

The AZURA Preparative HPLC system consisted of AZURA P 2.1L 100 mL sst pump with ternary LPG module, AZURA UVD2.1L detector with 3 mm, 2 µl flow cell, an AZURA assistant module with a 6 port multi position 1/8" sst valve (solvent selection), a 6 port 2 position 1/16" sst injection valve, a P 4.1S 50 ml sst feed pump and a Labocol vario-4000 fraction collector. Final purification method was divided into two phases: SPE loading and target purification. SPE loading: 1) Conditioning 1.5 min with 20 mL/min 100 % ACN; 2) Re-equilibration 2.5 min with 20 mL/min 20/80 ACN/H<sub>2</sub>O; 3) sample loading 1 min 5 mL/min 4) Washing 6.5 min with 20 mL/min; target purification: 20 min with 22 mL/min 30/70 ACN/H<sub>2</sub>O; at 210 nm and 25°C. Fraction analysis was performed with AZURA analytical HPLC system as described in application note [VFD0168](#).

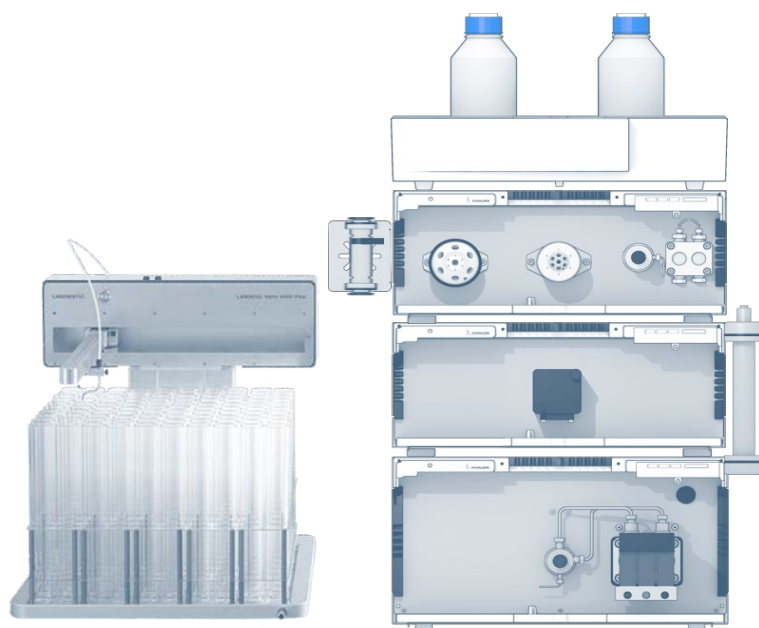
## REFERENCES

[1] "Stevia Leaf to Stevia Sweetener: Exploring Its Science, Benefits, and Future Potential" P. Samuel, K. T. Ayooob, B. A. Magnuson, et al. J Nutr, Volume 148, Issue 7, 1 July 2018, Pages 1186S-1205S

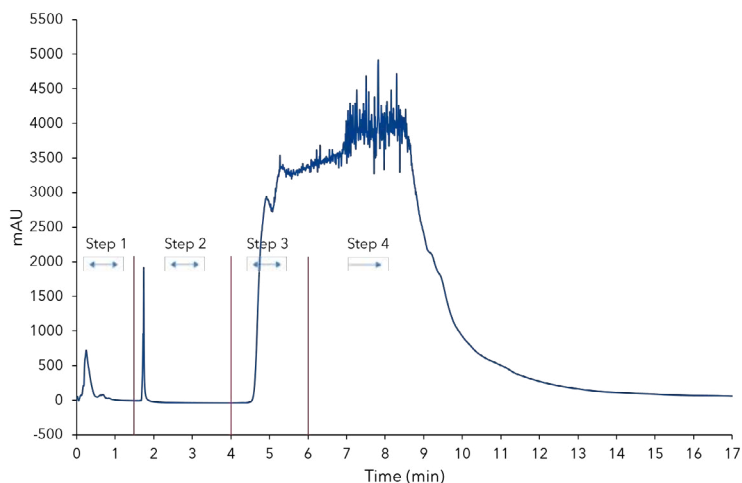
[2] Scale up converter:  
<https://www.knauer.net/en/knauer-scaleup-converter/p14082>

## CONCLUSION

A preparative HPLC approach for the purification of the most preferred steviol glycoside rebaudioside A from dried stevia leaves was investigated. During the method development an automatic online-SPE method was established thus reducing significantly the matrix in the sample. That should protect the main column from contamination and increases the loading with the main compounds. Nevertheless, the two components rebaudioside A and stevioside are coeluting and a clean separation is not possible under tested conditions. Pure rebaudioside A can be purified but with low yield.



## ADDITIONAL RESULTS



**Fig. A1** Sample loading on SPE column, 10 mL sample, step 1 - conditioning, step 2 - re-equilibration, step 3 - sample loading, step 4 - washing

## ADDITIONAL MATERIALS AND METHODS

**Tab. A1** Method parameters (preparative online-SPE)

Eluent A	100 % ACN				
Eluent B	20 %/80 % ACN/H <sub>2</sub> O				
Sample	Concentrated stevia extract				
Step	Flow rate	Time (min)	% A	% B	Sample (%)
Conditioning	20 mL/min	1.5	100	0	0
Re-equilibration	20 mL/min	2.5	0	100	0
Sample loading	5 mL/min	2	0	0	100
Washing	20 mL/min	9.5	0	100	0
Run temperature	25°C	Run time	15.5 min		
Injection volume	10 mL	Injection mode	Feed pump		
Detection wavelength	210 nm	Data rate	2 Hz		
		Time constant	0.05 s		

**Tab. A2** Method parameters (preparative method)

Eluent A	30 %/70 % ACN/H <sub>2</sub> O		
Eluent B	-		
Gradient	isocratic		
Flow rate	22 mL/min	System pressure	80 bar
Run temperature	25°C	Run time	20 min
Injection volume	From above	Injection mode	-
Detection wavelength	210 nm	Data rate	2 Hz
		Time constant	0.05 s

**Tab. A3** System configuration

Instrument	Description	Article No.
Pump	AZURA P 2.1L, 100 mL, SST AZURA ternary module for P 2.1L	<a href="#">APE20KA</a> <a href="#">AZZ00AB</a>
Detector	AZURA UVD 2.1L	<a href="#">ADA01XA</a>
Assistant	Left: 6 Mpos, 1/8", sst Middle: 6Port2Pos, 1/16", sst Right: P4.1S, 50ml, sst	<a href="#">AYEKEABR</a>
Flow cell	3 mm, 2 µL; 1/16"	<a href="#">A4069</a>
Column	Eurospheer II 100-10 C18 250x4.6 mm Eurospheer II 100-10 C18 250x20 mm Eurospheer II 100-5 C18 30x20 mm	<a href="#">25VE181E2N</a> <a href="#">25PE181E2N</a> <a href="#">03PE181E2J</a>
Fraction collector	Labocol Vario-4000	<a href="#">A591022</a>
Software	PurityChrom5 Basic	<a href="#">A2650</a>

## RELATED KNAUER APPLICATIONS

[VFD0168](#) - Oh so sweet - Quantification of steviol glycosides in Stevia samples with RP-HPLC

[VFD0155](#) - Sensitive online SPE determination of Bisphenol A in water samples

# A D E K - Easy separation of fat-soluble vitamins using GPC/SEC

Juliane Boettcher, Jan Wendrich, Kate Monks; applications@knauer.net  
KNAUER Wissenschaftliche Geräte GmbH, Hegauer Weg 38, 14163 Berlin;  
www.knauer.net

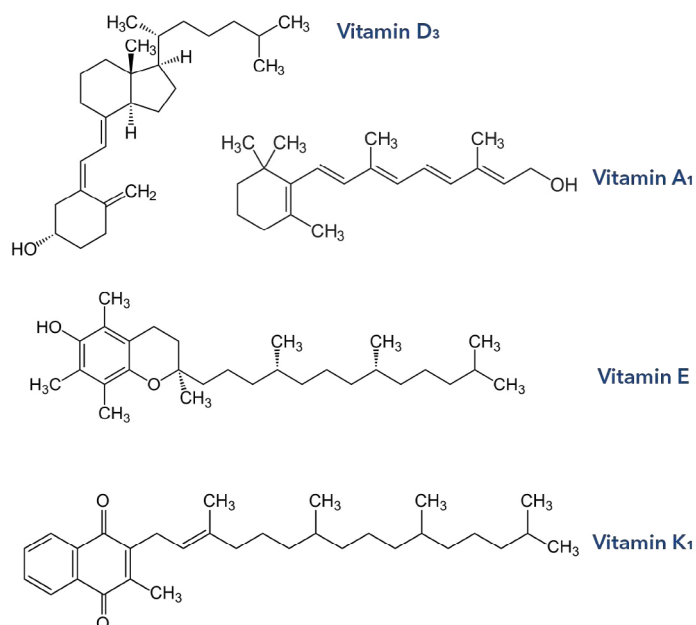


## SUMMARY

Vitamins are essential micronutrients that are needed in small amounts for various roles throughout the human body. Vitamins are divided into two groups: water-soluble (B-complex vitamins and C vitamins) and fat-soluble vitamins (A, D, E, and K). The fat-soluble vitamins are stored in the body for long periods of time and generally pose a greater risk for toxicity when consumed in excess than water-soluble vitamins [1]. Here, an analytical HPLC method based on size exclusion chromatography is described.

## INTRODUCTION

Fat-soluble vitamins are required for a wide variety of physiological functions. They are absorbed in the intestine in the presence of fat. Classical deficiencies of these vitamins can manifest clinically as night blindness (vitamin A), osteomalacia (vitamin D), increased oxidative cell stress (vitamin E), and haemorrhage (vitamin K) [2]. Since megadoses of vitamins A, D, E, or K can be toxic and may lead to health problems, it is necessary to provide quality control of dietary supplement products to guarantee the right indication of vitamin concentration. Therefore, a HPLC method for the analysis of fat-soluble vitamins was developed based on the separation principle of size exclusion.



Structural formulas of typical fat-soluble vitamins

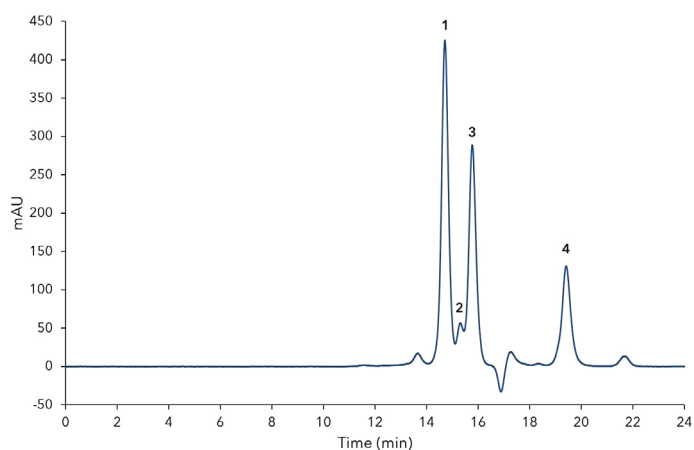


# A D E K - Separation of fat-soluble vitamins using GPC/SEC

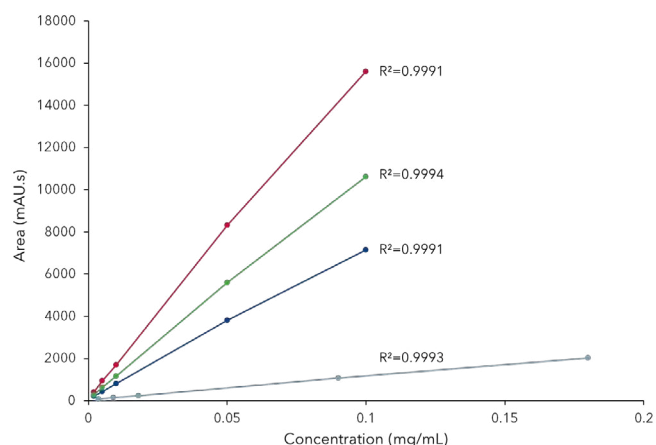
## RESULTS

A mixed standard of the fat-soluble vitamins was prepared and dissolved in tetrahydrofuran. For quantification, calibration curves for the four vitamins in ranges from 0.002 mg/mL to 0.1 mg/mL for vitamins A, D, K and from 0.0045 mg/mL to 0.18 mg/mL for vitamin E were determined. **Fig. 1** shows the mixed vitamin standard at a concentration of 0.05 mg/mL (A, D, K) and 0.09 mg/mL (E). The calibration showed a good

linearity and for all compounds  $R^2 > 0.999$  was achieved (**Fig. 2**). **Tab. 1** summarizes the calculated LOD (S/N=3) and LOQ (S/N=10) values for the separation. Vitamin E showed the least sensitivity but nevertheless LOD and LOQ values reside in an appropriate range e.g. the analysis of dietary supplement products, where high amounts of vitamins are expected.



**Fig. 1** Chromatogram of a mixed standard of fat-soluble vitamins at 0.05 mg/mL (A, D, K) and 0.09 mg/mL (E), 1) vitamin A palmitate, 2) vitamin E, 3) vitamin D3, 4) vitamin K



**Fig. 2** Calibration curves for vitamin D3 (red), vitamin A (green), vitamin K (blue), and vitamin E (grey); corresponding linearity values are indicated

**Tab. 1** Calculated LOD and LOQ values

Substance	LOD (S/N=3) in $\mu\text{g/mL}$	LOQ (S/N=10) in $\mu\text{g/mL}$
Vitamin A palmitate	0.10	0.34
Vitamin E	2.00	6.40
Vitamin D3	0.16	0.54
Vitamin K	0.40	1.33

## MATERIALS AND METHODS

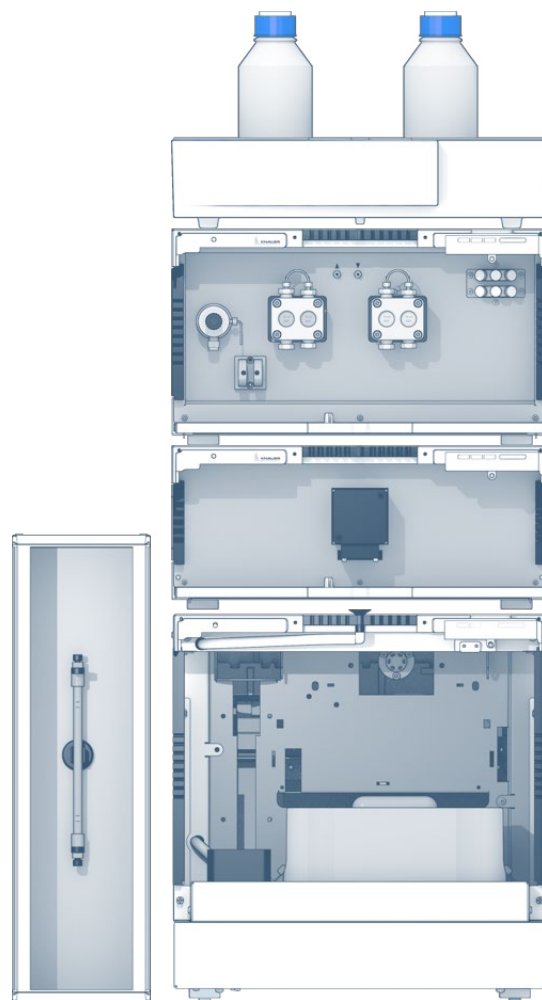
The used AZURA® analytical system was equipped with an AZURA P 6.1L pump suitable for normal phase applications. Furthermore a 2 channel GPC degasser was used. Acquisition was performed with an AZURA UVD 2.1L and an analytical flow cell. For injection, an AZURA autosampler AS 6.1L was used. The column thermostat CT 2.1 was part of the system. The isocratic method ran at a flow rate of 1 mL/min for 25 minutes. Stabilized tetrahydrofuran was used as eluent. The column temperature was set to 40 °C and vitamins were detected at 280 nm. A column tandem was used of two times AppliChrom ABOA StyDiViBe, with a pore size of 35 Å, covering a molecular weight range from 100 to 2500 Da in a dimension 300 x 8 mm ID.

## CONCLUSION

The isocratic method based on size exclusion separation mechanism is an easy possibility for the determination of the four fat-soluble vitamins and a valuable addition to commonly used reversed phase gradient methods. Although, the peaks are not completely baseline separated it is possible to perform quantification. The method can be used for the quality control of dietary supplement products. To obtain a better resolution for vitamin E, the extension of the separation distance would be reasonable. This could be achieved by adding a third column with the same pore size.

## REFERENCES

- [3] Fat-Soluble Vitamins: A, D, E, and K; Fact Sheet No. 9.315, Food and Nutrition Series/Health, <http://extension.colostate.edu/topic-areas/nutrition-food-safety-health/fat-soluble-vitamins-a-d-e-and-k-9-315/>
- [4] Fat-Soluble Vitamins: Clinical Indications and Current Challenges for Chromatographic Measurement, Ali A. Albahrani and Ronda F. Greaves; <https://www.ncbi.nlm.nih.gov/pmc/articles/PMC4810759/>



## ADDITIONAL MATERIALS AND METHODS

**Tab. A1** Method parameters

Column temperature	40°C
Injection volume	100 µL
Injection mode	Full loop
Detection	UV 280 nm
Data rate	20 Hz
Time constant	0.05 s

**Tab. A2** Pump parameters

Eluent A	Tetrahydrofuran (stabilized)
Flow rate	1 mL/min
Pump program	isocratic
Run time	25 min

**Tab. A3** System configuration

Instrument	Description	Article No.
Pump	AZURA P 6.1L, HPG for normal Phase	<a href="#">APH38ED</a>
Degasser	2 channel GPC degasser	<a href="#">A5335</a>
Autosampler	AZURA AS 6.1L	<a href="#">AAA00AA</a>
Detector	AZURA UVD 2.1L	<a href="#">ADA01XA</a>
Flow cell	Analytical UV Flow Cell	<a href="#">A4061XB</a>
Thermostat	AZURA CT 2.1	<a href="#">A05852</a>
Column	2 x AppliChrom ABOA StyDiViBe, 35 Å (100 - 2500 Da), 5 µm, 300 x 8 mm ID	<a href="#">30GA470ABJ</a>
Software	ClarityChrom 7.4.2 - Workstation, autosampler control included	<a href="#">A1670</a>

## RELATED KNAUER APPLICATIONS

[VFD0162](#) - Separation of ascorbic acid and vitamin B complexes - essentially required nutrients



# Be(e) wary - determination of neonicotinoid insecticides in honey

Juliane Böttcher, Kate Monks; applications@knauer.net  
KNAUER Wissenschaftliche Geräte GmbH, Hegauer Weg 38, 14163 Berlin; www.knauer.net



## SUMMARY

Neonicotinoids are active substances used in plant protection products to control harmful insects. They are systemic pesticides, which means that they are taken up by the plant and transported through its leaves, flowers, roots, and stems, as well as pollen and nectar. Neonicotinoids affect the central nerve system of insects, leading to eventual paralysis and death [1]. Three honey samples from different sources were analysed for neonicotinoid content according to current regulating guidelines via a fast and simple HPLC method.

## INTRODUCTION

Neonicotinoids are one of the most widely used classes of pesticides [2]. Five neonicotinoid insecticides are approved as active substances in the EU for the use in plant protection products, namely clothianidin, imidacloprid, thiamethoxam, acetamiprid, and thiacloprid [1]. They are closely monitored by the European Commission. Because of the potential risk for bees, the use of three of the substances (imidacloprid, clothianidin, thiamethoxam) was restricted in 2013 (see Regulation (EU) No 485/2013) [3]. In April 2018, the European Commission banned these three neonicotinoids for the outdoor use and only the permit for usage in permanent greenhouse remains [4]. For acetamiprid the EFSA established a low risk to bees.

A ban or further restrictions of this substance are neither scientifically nor legally appropriate. The fifth neonicotinoid, thiacloprid, is a candidate for substitution based on its endocrine disrupting properties [3]. In this application clothianidin, thiamethoxam, imidacloprid, and acetamiprid in honey samples are determined referring to the maximum residue levels which are specified in Commission Reg. (EU) 2017/671 [5], Commission Reg. (EU) 491/2014 [6] and Commission Reg. (EU) 2017/626 [7]. Three different honey samples have been tested. One of the samples was the KNAUER honey, produced from a bee colony located in the KNAUER garden. The other ones were commercially available canola honey and fruit blossom honey.

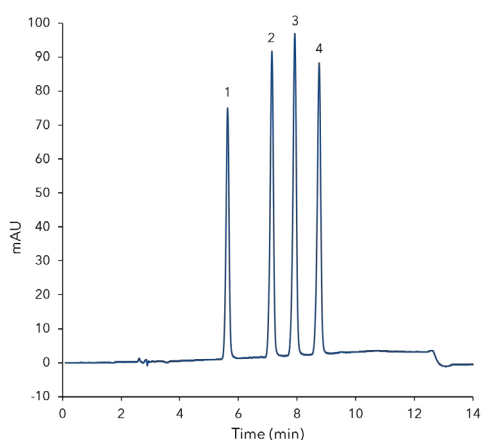


# Be(e) wary – determination of neonicotinoid insecticides in honey

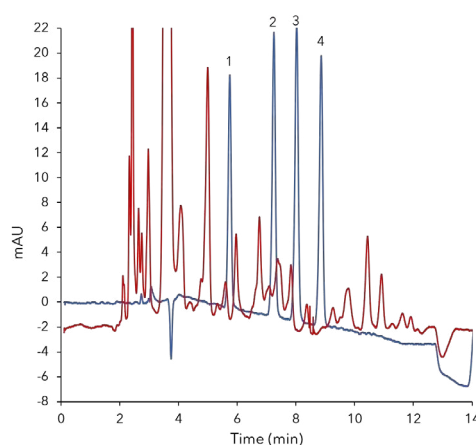
## RESULTS

A reversed phase method was developed where the four neonicotinoids are baseline separated. The method was optimized regarding temperature and gradient slope using DryLab simulation software. A calibration in a range from 0.5 µg/mL to 10 µg/mL was prepared. **Fig 1** shows the separation of a mixed standard at a concentration of 10 µg/mL. The calibration showed a good linearity and all correlation coefficients are calculated as  $R^2 > 0.9996$ . Based on the measurement at a concentration of 0.5 µg/mL the LOD and LOQ were calculated. The calculated values for the single compounds are summarized in **Tab A1** (additional information). Sample preparation was carried out using a citrate-buffered QuEChERS

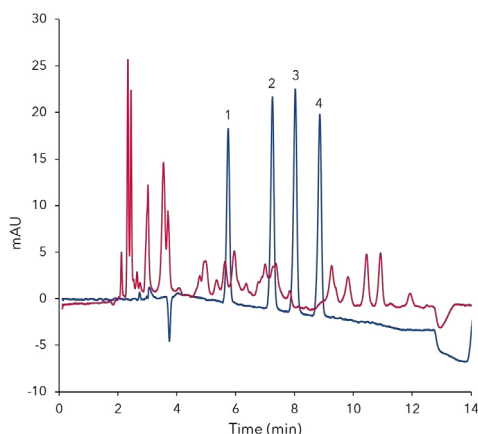
extraction. The recovery rate including sample preparation was determined at three different levels: LOQ, 2 x LOQ, upper end of calibration. For the compounds following recovery rates were calculated (averaged values over all levels): clothianidin 87 %, thiamethoxam 91 %, imidacloprid 92% and acetamiprid 95 %. Furthermore, three different honey samples were analyzed regarding neonicotinoids. **Fig 2 to 4** show the chromatograms of the QuEChERS extracted and cleaned samples. In one of three samples residues of clothianidin were detected but they were in the range of limit of detection and hence far below the maximum residue level of 0.05 mg/kg for honey and other apiculture products [8].



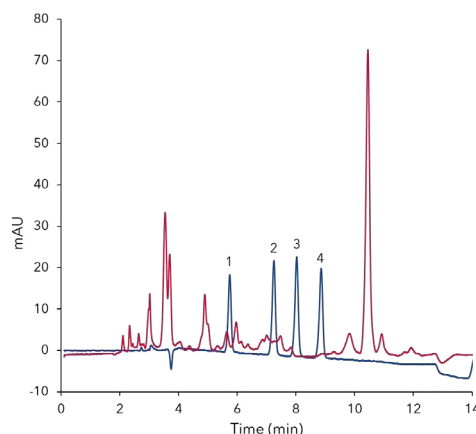
**Fig. 1** Chromatogram of mixed standard at 10 µg/mL, 1) thiamethoxam, 2) clothianidin, 3) imidacloprid, 4) acetamiprid



**Fig. 2** Overlay of standard at 2.5 µg/mL (blue) and cleaned sample of fruit blossom honey (red)



**Fig. 3** Overlay of standard at 2.5 µg/mL (blue) and cleaned sample of KNAUER honey (red)



**Fig. 4** Overlay of standard at 2.5 µg/mL (blue) and cleaned sample of fruit blossom

## MATERIALS AND METHODS

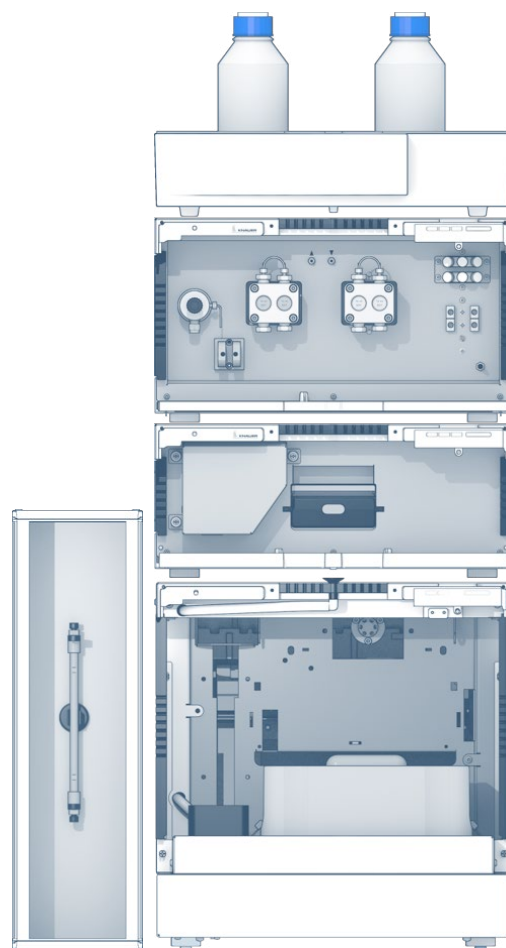
The application was performed on an AZURA HPLC Plus System equipped with an AZURA P 6.1L HPG pump, AZURA CT 2.1 column thermostat, AZURA autosampler AS 6.1L and AZURA DAD 6.1L detector. The mobile phase was a composition of acetonitrile and water, both containing 0.1 % formic acid. The gradient method has a total run time of 15 minutes including equilibration. The flow rate was set to 1 mL/min. Temperature was set to 30 °C and detection was carried out at 260 nm with a data rate of 20 Hz. For the sample preparation BEKOlut QuEChERS Citrate-Kit-01 and PSA-Kit-02 were used. The QuEChERS extraction protocol is described in the additional results section. The used column in a dimension 250 x 4.6 mm ID was filled with Eurospher II 100 5 C18P silica.

## REFERENCES

- [1] [https://ec.europa.eu/food/plant/pesticides/approval\\_active\\_substances/approval\\_renewal/neonicotinoids\\_en](https://ec.europa.eu/food/plant/pesticides/approval_active_substances/approval_renewal/neonicotinoids_en)
- [2] Codling, G., et al. Concentrations of neonicotinoid insecticides in honey, pollen and honey bees (*Apis mellifera* L.) in central Saskatchewan, Canada, *Chemosphere*, Volume 144, 2016, Pages 2321-2328, ISSN 0045-6535, <https://doi.org/10.1016/j.chemosphere.2015.10.135>.
- [3] [https://ec.europa.eu/food/plant/pesticides/approval\\_active\\_substances/approval\\_renewal/neonicotinoids\\_en](https://ec.europa.eu/food/plant/pesticides/approval_active_substances/approval_renewal/neonicotinoids_en)
- [4] Official Journal of the European Union, L 132, 30 May 2018, <https://eur-lex.europa.eu/legal-content/EN/TXT/?uri=OJ:L:2018:132:TOC>
- [5] Commission Regulation (EU) 2017/671 of 7 April 2017 amending Annex II to Regulation (EC) No 396/2005, <http://data.europa.eu/eli/reg/2017/671/oj>
- [6] Commission Regulation (EU) No 491/2014 of 5 May 2014 amending Annexes II and III to Regulation (EC) No 396/2005, <http://data.europa.eu/eli/reg/2014/491/oj>
- [7] Commission Regulation (EU) 2017/626 of 31 March 2017 amending Annexes II and III to Regulation (EC) No 396/2005, <http://data.europa.eu/eli/reg/2017/626/oj>
- [8] Regulation (EC) No 396/2005 of the European Parliament and of the Council of 23 February 2005, <http://data.europa.eu/eli/reg/2005/396/oj>

## CONCLUSION

Using QuEChERS extraction for sample preparation makes the handling of samples very easy and reduces time compared to e.g. solid phase extraction. Fortunately, neither the KNAUER honey nor the other tested samples were contaminated with neonicotinoids. Although banning neonicotinoids for the outside use, monitoring them is still mandatory. The developed method is suitable for quality control of honey or other apiculture products.



## ADDITIONAL RESULTS

**Tab. A1** LOD and LOQ values for single compounds

Compound	LOD (S/N=3) in ng/mL	LOQ (S/N=10) in ng/mL
Thiamthoxam	52.5	<a href="#">175.1</a>
Clothianidin	48.2	<a href="#">160.6</a>
Imidacloprid	45.8	<a href="#">152.5</a>
Acetamiprid	49.6	<a href="#">165.3</a>

## ADDITIONAL MATERIALS AND METHODS

**Tab. A2** Method parameters

Eluent A	$d_d$ H <sub>2</sub> O + 0.1 % formic acid		
Eluent B	Acetonitrile + 0.1 % formic acid		
Flow rate	1 mL/min		
Pump program	Time (min)	% A	% B
	0	75	25
	8	65	35
	10	65	35
	10.02	75	25
	15	75	25
Column temperature	30°C	Injection volume	5 µL
Injection mode	Partial loop	Detection	UV 260 nm
Data rate	20 Hz	Time constant	0.05 s

**Tab. A3** Sample preparation

Extraction	
Step 1	Weigh 10 g of honey sample into a 50 ml falcon tube
Step 2	Add 10 mL of deionized water, shake until honey is dissolved
Step 3	Add 10 mL of acetonitrile
Step 4	Add the contents of the BEKOLut Citrate-Kit-01 and shake for 1 minute
Step 5	Centrifuge samples at 4000 x g for 5 minutes
Clean-up	
Step 1	Transfer 3 mL of supernatant into a BEKOLut PSA-Kit-02 dispersive SPE tube
Step 2	Vortex the samples for 30 seconds
Step 3	Centrifuge samples at 4000 x g for 5 minutes
Step 4	Transfer purified supernatant into an appropriate vessel/vial

**Tab. A4** System configuration

Instrument	Description	Article No.
Pump	AZURA P6.1L, HPG	<a href="#">APH35EA</a>
Autosampler	AZURA AS 6.1L	<a href="#">AAA00AA</a>
Detector	AZURA DAD 6.1L	<a href="#">ADC11</a>
Flow cell	High Sensitivity KNAUER LightGuide UV Flow Cell Cartridge	<a href="#">AMD59XA</a>
Column thermostat	AZURA CT 2.1	<a href="#">A05852</a>
Column	KNAUER Vertex Plus column, Eurospher II 100-5 C18P, 250 x 4.6 mm ID	<a href="#">25EE182E2J</a>
Software	ClarityChrom 7.4.2 - Workstation, autosampler control included ClarityChrom 7.4.2 - PDA extension	<a href="#">A1670</a> <a href="#">A1676</a>

## RELATED KNAUER APPLICATIONS

[VFD0161](#) - Determination of sugars in honey using HILIC separation and RI detection

[VFD0169](#) - Determination of sugars in honey - comparison of refractive index and light scattering detection

[VEV0012J](#) - Determination of Carbamate Insecticides by HPLC with post-column derivatization

# Determination of six steviol glycosides using reversed phased HPLC and online SPE

Johannes Menke, Yannick Krauke, Juliane Böttcher, Kate Monks; applications@knauer.net  
KNAUER Wissenschaftliche Geräte GmbH, Hegauer Weg 38, 14163 Berlin; www.knauer.net



## SUMMARY

Steviol glycosides are the main sweetening compounds in *Stevia rebaudiana* and can be used as natural sugar substitutes, because they have a far higher sweetening power than normal sucrose or glucose. The sweetness is estimated to be about 400 times higher. This gradient method provides a fast determination of six steviol glycosides using reversed phase HPLC and UV detection. Furthermore, an automated matrix reduction is achieved by online SPE (solid phase extraction), speeding up sample preparation and guaranteeing a high sample throughput.

## INTRODUCTION

For several years research has been undertaken to find sugar substitutes that are calorie free but have the same taste and properties as classic sugar, for diabetics and as part of a calorie-controlled diet. One popular substitute is the so-called "Stevia" which is a mixture of steviol glycosides isolated from the plant *Stevia Rebaudiana* (REF1). The steviol glycoside rebaudioside A is the main compound of interest as it is the sweetest and less bitter compound of the extract but often a mixture of rebaudioside A and stevioside is

found in the "Stevia" products. In addition, also other steviol glycosides like rebaudioside B, rebaudioside C, dulcoside A and steviolbioside are commonly present in stevia mixtures and were therefore also analytes of interest in the developed method, as they are not desired in finished products. A determination method for steviol glycosides in stevia samples, with partly automated sample preparation and matrix reduction could thus be used for an easy quality control of stevia food products.



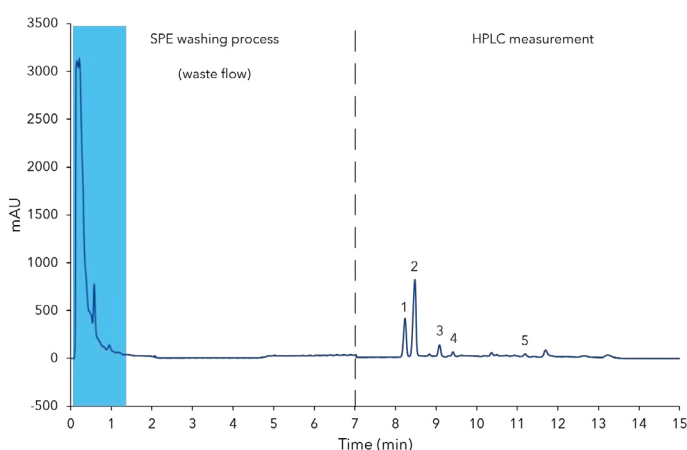
# Determination of six steviol glycosides using reversed phased HPLC and online SPE

## RESULTS

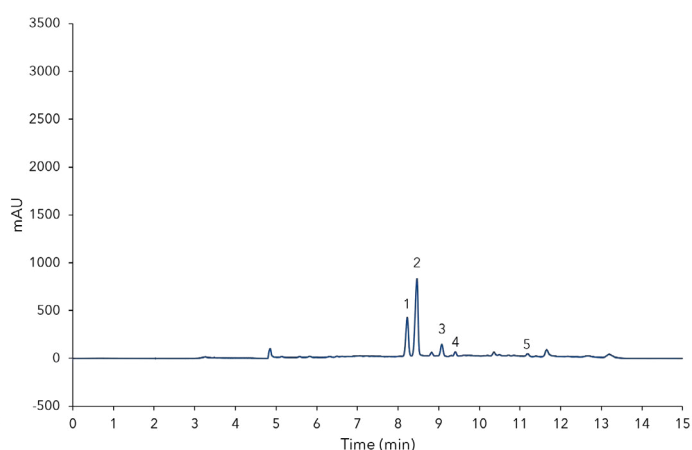
A gradient method for six steviol glycosides was developed beforehand (application note [VFD0168](#)). For this method a manual SPE protocol was used which was then transferred to the online SPE approach. The online SPE method was previously applied in preparative HPLC (application note [VFD0171](#)). For the analytical method valve switching sequences, as well as washing and conditioning solutions, were adopted from the preparative method. An extract of dried stevia leaves was used as sample. The extraction was performed as described in the application note for the original analytical method ([VFD0168](#)) as

well as the 5-point calibration with mix-standard solutions of rebaudioside A, stevioside, rebaudioside C, dulcoside A, rebaudioside B and steviolbioside. The calibration was set for a range from 0.01 mg/mL to 0.15 mg/mL of each individual compound. The injection volume was 20  $\mu$ L in full loop mode.

The flow passing the SPE column was monitored to see the effect of the washing procedure (**Fig 1**). After 7 min the main column flow was directed to the detector by swit



**Fig. 1** Measurement of washing process; blue area: matrix; 1) rebaudioside A, 2) stevioside, 3) rebaudioside C, 4) dulcoside A, 5) steviolbioside; 20  $\mu$ L injection of Stevia extract; 0-7 min) measuring of SPE washing process, 7-15 min) measuring of HPLC



**Fig. 2** Measurement of sample only; 1) rebaudioside A, 2) stevioside, 3) rebaudioside C, 4) dulcoside A, 5) steviolbioside; 20  $\mu$ L injection of Stevia extract

## MATERIALS AND METHODS

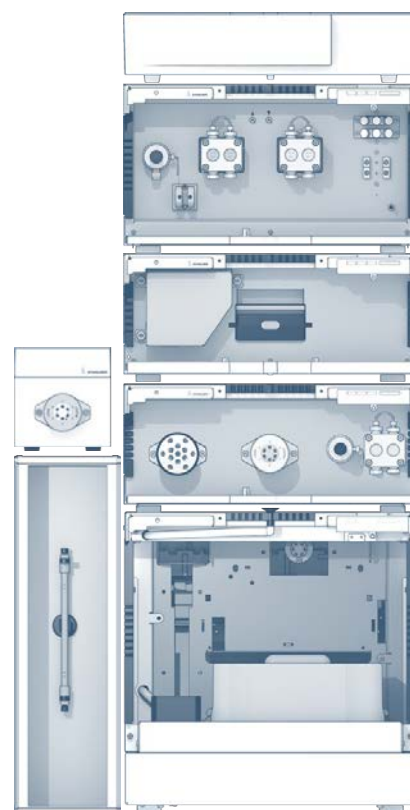
As analytical system an AZURA Online SPE System equipped with an autosampler AS 6.1L, a binary high-pressure gradient pump P 6.1L with 10 mL pump head, a CT 2.1L column thermostat and a diode array detector DAD 2.1L was used as described in application note VFD0168. The SPE module of the system consists of an AZURA assistant ASM 2.1L equipped with a 12 port multi position 1/8" sst valve (solvent selection), a 6 port 2 position 1/16" sst injection valve, a P4.1S 50 ml sst feed pump. Injection was automated using an autosampler AZURA AS 6.1L. The eluent was a composition of A: water and B: acetonitrile and was also used to elute the analytes from the SPE column. As washing solution a premixed composition of 20:80 acetonitrile:water (v/v) was used. Conditioning of the column was performed with acetonitrile. A Vertex Plus column filled with Eurospher II 100-5 C18 silica in a dimension 250 x 4.6 mm ID with precolumn was used. For the SPE a column with the same material, but with dimension 30 x 4.6 mm ID was chosen. The sample was applied to an already conditioned and equilibrated SPE column, followed by a washing procedure. Next, elution on the SPE column is started by introduction of the water:acetonitrile gradient in reverse flow. Subsequently, the flow is then directed to the main column. Meanwhile the SPE column is conditioned and reequilibrated with washing solution using the feed pump.

## REFERENCES

[1] "Stevia Leaf to Stevia Sweetener: Exploring Its Science, Benefits, and Future Potential" P. Samuel, K. T. Ayoob, B. A. Magnuson, et al. J Nutr, Volume 148, Issue 7, 1 July 2018, Pages 1186S-1205S

## CONCLUSION

This method enhances the already fast and robust analysis of steviol glycosides provided by the previous HPLC method keeping all its advantages but adding the capabilities of online SPE. Thus, an easy matrix reduction can be achieved very fast only adding 3 minutes to the original runtime of 12 minutes. This automated matrix reduction saves up time otherwise needed for manual solid phase extraction and allows a high sample throughput. In addition, the analytical main column is spared from being exposed to high concentrations of matrix, enhancing the columns longevity. The monitoring of the washing process also easily allows an optimization of the process. Although the method is now extended to a runtime of 15 min, the overall process of stevia analysis was shortened by a great deal. Additionally, since the SPE column is conditioned for the next run meanwhile sample analysis thus saving even more time.



## ADDITIONAL MATERIALS AND METHODS

**Tab. A1** Method parameters (analytical method)

Column temperature	40 °C
Injection volume	20 µL
Injection mode	Full loop
Detection	UV 210 nm
Data rate	20 Hz

**Tab. A2** Pump parameters (main pump)

Eluent A	ddH <sub>2</sub> O		
Eluent B	Acetonitrile		
Flow rate	1.2 mL/min		
<b>Pump program</b>			
<b>Time (min)</b>	<b>A [%]</b>	<b>B [%]</b>	<b>Flow [mL/min]</b>
0	70.0	30.0	1.2
3	70.0	30.0	1.2
10	55.0	45.0	1.2
11	55.0	45.0	1.2
11.02	70.0	30.0	1.2
15	70.0	30.0	1.2

**Tab. A3** Pump parameters (SPE assistant feed pump)

Eluent A	20:80 ACN:Water (v/v)
<b>Pump program</b>	
<b>Time (min)</b>	<b>flow [mL/min]</b>
0	2
2	2
2.02	0.5
9.98	0.5
10	2
15	2

**Tab. A4** SPE assistant valve program

<b>Time (min)</b>	<b>Valve left (Solvent selection)</b>	<b>Valve middle (Injection)</b>
0	Pos 2: 20:80 ACN:Water (v/v)	Load
2	Pos 1: ACN	Inject
10	Pos 1: ACN	Load
12	Pos 2: 20:80 ACN:Water (v/v)	Load
15	Pos 2: 20:80 ACN:Water (v/v)	Load

**Tab. A5** System configuration & data

Instrument	Description	Article No.
Pump	AZURA P6.1L (HPG) with 10 mL pump head sst	<a href="#">APH35EA</a>
Autosampler	AZURA AS 6.1L	<a href="#">AAA00AA</a>
Detector	AZURA DAD 2.1L	<a href="#">ADC01</a>
Flow cell	Standard KNAUER LightGuide UV Flow Cell Cartridge 10mm, 2µL	<a href="#">AMC19XA</a>
Thermostat	AZURA CT 2.1	<a href="#">A05852</a>
Assistant	AZURA ASM 2.1L Left: 12 Mpos, 1/8", sst Middle: 6 Port 2Pos, 1/16", sst Right: P4.1S, 50 mL, sst	<a href="#">AYEKEABR</a>
Valve Drive	AZURA Valve drive V 2.1S 6 Port 2Pos, 1/16", sst	<a href="#">AWA10AA</a>
Column	Vertex Plus Column, Eurospher II 100 5 C18, 250 x 4.6 mm ID with precolumn Vertex Plus Column, Eurospher II 100 5 C18, 30 x 4.6 mm ID	<a href="#">25VE181E2N</a> <a href="#">03EE181E2J</a>
Software	ClarityChrom 7.4.2 - Workstation. autosampler control included ClarityChrom 7.4.2 - PDA extension	<a href="#">A1670</a> <a href="#">A1676</a>

## RELATED KNAUER APPLICATIONS

[VFD0168](#) - Oh so sweet - Quantification of steviol glycosides in Stevia samples with RP-HPLC

[VFD0170](#) - Scale-Up of an analytical HPLC method for steviol glycosides to a preparative approach

[VFD0171](#) - Advantages of preparative online SPE compared to batch LC for stevia purification

[VFD0155](#) - Sensitive online SPE determination of Bisphenol A in water samples



# Verification of the mycotoxin patulin from apple juice with isocratic HPLC

Kristin Folmert, Kate Monks; applications@knauer.net  
KNAUER Wissenschaftliche Geräte GmbH, Hegauer Weg 38, 14163 Berlin; www.knauer.net



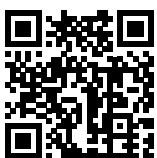
## SUMMARY

The deleterious and mutagenic mould fungus product patulin can form during wrong cidermaking process of fruits like apple. The permitted daily exposure for patulin was declared as 0.05 µg/mL in apple juice by the scientific committee for foodstuffs of the European Commission. [1] The specified determination routines have to be performed with HPLC according to official guidelines. Here, a fast protocol for the determination of patulin from apple juice with AZURA® HPLC plus and a Eurospher II column is described.

## INTRODUCTION

The lactone patulin belongs to the chemical group of polyketides. It is soluble in acidic water and many organic solvents like methanol. Different species of fungi, such as aspergillus, byssochlamys, and penicillium, growing on rotting parts of fruits including apples, cherries, plums, strawberries, blueberries and pears can produce the mycotoxin patulin. [2] Juices can be contaminated with patulin if affected fruits are used for the cidermaking process. As a result of its thermal stability, patulin cannot be destroyed by pasteurization or thermal denaturation. Next to its antibiotic qualities, patulin is implicated as a possible carcinogen but the toxicity of patulin is primarily

through its affinity to sulfhydryl groups which results in inhibition of enzymes. [3] Major acute toxicity findings include gastrointestinal problems, neurotoxicity, pulmonary congestion, and edema. [3] To protect customers from patulin in juices like apple juice, the FDA and the European Commission (EU) recommend a maximum daily ingestion concentration of 0.4 µg/kg body weight for humans according to 93/5/EWG and 0.05 µg/mL in apple juice per day. Furthermore, the EU has set a limit of 25 µg/kg in solid apple products and 10 µg/kg in baby food (2003/598/EG). [1]

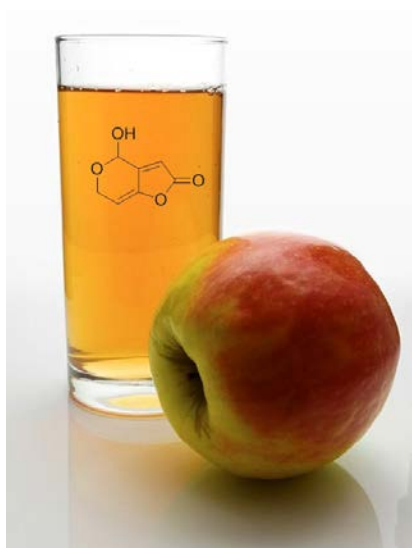


# Verification of the mycotoxin patulin from apple juice with isocratic HPLC

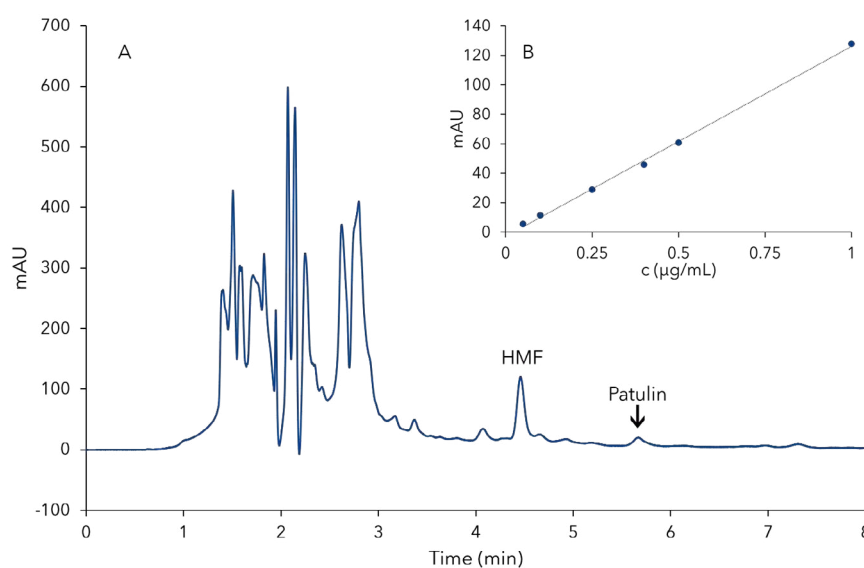
## RESULTS

The very fast and robust method with AZURA HPLC plus for the identification of patulin in juices like apple juice enables the validation of the concentration according to the regulation of the EU and FDA and at lower concentrations. The minimum concentration, which was measured with a 50  $\mu\text{L}$  injection was 0.05  $\mu\text{g}/\text{mL}$  apple juice with a signal to noise ratio (S/N) of 216.4. The low noise value of 50  $\mu\text{Au}$  enables a detection of

patulin at the limit of quantification (LOQ) with a concentration of 0.003  $\mu\text{g}/\text{mL}$ . The short retention times of hydroxymethylfurfural (HMF) and patulin enable a high efficiency for the analysis. A good separation from all matrix peaks ( $R_s > 1.5$ ) comfortably assures the quality of the measurements, as shown in **Fig 2 A** for the concentration of 0.25  $\mu\text{g}/\text{mL}$  patulin and HMF.



**Fig. 1** Patulin contamination in apple juice



**Fig. 2** Chromatogram of 50  $\mu\text{L}$  injections from apple juice concentrate spiked with 0.25  $\mu\text{g}/\text{mL}$  patulin and HMF (A) and an concentration curve of patulin with the same injection volume (B). Concentrations of 1.00  $\mu\text{g}/\text{mL}$ , 0.50  $\mu\text{g}/\text{mL}$ , 0.40  $\mu\text{g}/\text{mL}$ , 0.25  $\mu\text{g}/\text{mL}$ , 0.10  $\mu\text{g}/\text{mL}$  and 0.05  $\mu\text{g}/\text{mL}$  patulin ( $n=3$ ) for the concentration curve

## MATERIALS AND METHODS

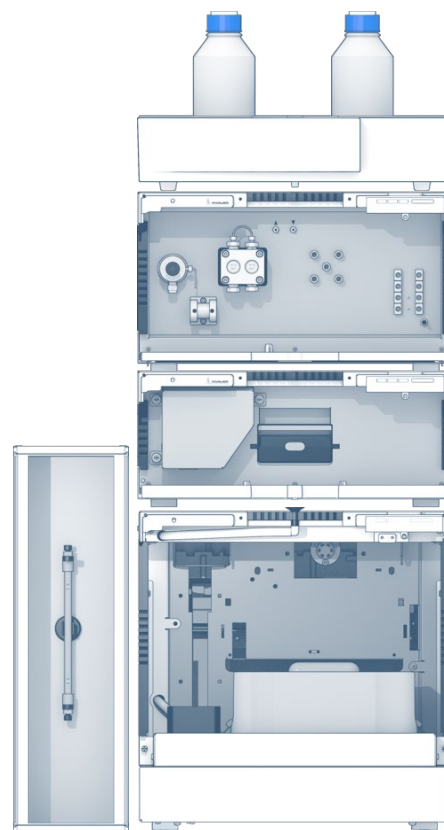
An AZURA HPLC plus system with the possibility to cool the autosampler rack to restore the quality of the food samples and a DAD detector with booster flow cell to monitor impurities at different wavelength was used to develop a simple and fast isocratic method. The eluent was a mixture of 10 % acetonitrile in water. The separation was realized within 7 minutes and with a phenyl endcapped Eurospher II 100-5 Phenyl column at an ambient temperature of 40°C. Therefore, 10 mL of gravy juice were mixed with 600 µL Pectinase enzyme and incubated at 37°C for 3 h before centrifuged at 3500 U/min for 10 min. After removing the centrifugate, the liquid was centrifuged again with the same conditions. The now concentrated apple juice is prepared for HPLC analysis. For the measurements in **Fig 2 A**, the concentrated juice was mixed with a standard solution of HMF and patulin to gain a concentration of 0.25 µg/mL. To evaluate the concentration in apple juice a concentration curve between 0.05 µg/mL to 1 µg/mL of patulin was measured using a standard of patulin in water (**Fig 2 B**).

## REFERENCES

- [1] 2003/598/EG, Amtsblatt der Europäischen Union zur Prävention und Reduzierung der Patulinkonzentration in Apfelsaft und Apfelsaftzutaten in anderen Getränken, 2003, L203/54. <https://eur-lex.europa.eu/legal-content/DE/TXT/PDF/?uri=CELEX:32003H0598&from=EN>
- [2] G. C. Llewellyn, J. A. McCay, R. D. Brown, D. L. Musgrove, L. F. Butterworth, A. E. Munson, Jr. K. L. White, Immunological evaluation of the mycotoxin patulin in female B6C3F1 mice. *Food Chem. Toxicol.* 1998, 36, 1107-1111.
- [3] O. Puel, P. Galtier, I. P. Oswald, Biosynthesis and Toxicological Effects of Patulin, *Toxins*, 2010, 2 (4): 613-631.

## CONCLUSION

A fast and efficient HPLC method was realized with AZURA HPLC plus and an isocratic method in only 7 minutes retention time. The cooling possibility of the autosampler elongates the life time of sensitive food samples and a column thermostat enables a continuous separation atmosphere above room temperature, which is crucial for the high robustness of the method. With these advantages the identification of patulin from apple juice can be realized down to the very low concentration of 0.003 µg/mL, which is 16 times less than the recommended maximum daily ingestion concentration for humans according to 2003/598/EG of the EU.



## ADDITIONAL MATERIALS AND METHODS

Tab. A1 Method parameters

Eluent	ACN: <sub>dd</sub> H <sub>2</sub> O/1:9 (v:v)		
Flow rate	1 mL/min		
Column temperature	40°C	Injection volume	50 µL
Autosampler temperature	4°C	Injection mode	Full loop
Detection	275 nm	Data rate	10 Hz
		Time constant	0.1 s

Tab. A2 Instrument set up

Instrument	Description	Article No.
Pump	AZURA P6.1L, LPG	<a href="#">APH34EA</a>
Autosampler	AZURA AS 6.1L	<a href="#">AAA01AA</a>
Detector	AZURA DAD 6.1L	<a href="#">ADC11</a>
Flow cell	LuightGuide 50 mm	<a href="#">AMD59XA</a>
Column thermostat	AZURA CT 2.1	<a href="#">A05852</a>
Column	KNAUER Vertex Plus column, Eurospher II 100-5 Phenyl, 150 x 4.6 mm	<a href="#">15VE050E2J</a>
Software	ClarityChrom 7.4.2 - Workstation, autosampler control included ClarityChrom 7.4.2 - PDA extension	<a href="#">A1670</a> <a href="#">A1676</a>

## RELATED KNAUER APPLICATIONS

[VFD0042J](#) - Analysis of Flavonoids in Fruit Juice

[VFD0002J](#) - Determination of Naringine and Hesperidine in Fruit Juices

[VFD0152](#) - Determination of Aflatoxin M1 in Milk

# Purification of epigallocatechin gallate and other related polyphenols from green tea by mass-triggered fractionation

Jan Wendrich, Maria Glanz, Kate Monks - applications@knauer.net  
KNAUER Wissenschaftliche Geräte GmbH,  
Hegauer Weg 38, 14163 Berlin - www.knauer.net



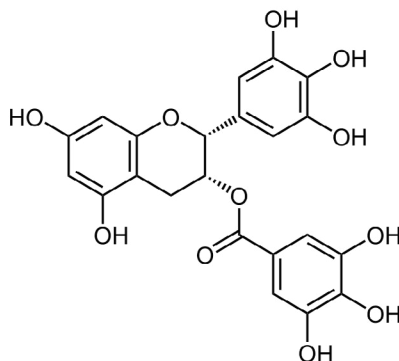
## SUMMARY

Epigallocatechin gallate is one of the major metabolites in green tea material and has shown positive effects on human health in several studies. This target molecule was isolated together with three other polyphenolic compounds in a short time with an AZURA® Preparative HPLC system using mass-triggered fractionation. The number of fractions was reduced to a minimum by this technique leading to a significant decrease in past analysis time showing that mass-directed purification is the ideal method in the isolation of natural products.

## INTRODUCTION

Catechins are polyphenolic metabolites that appear in plants. These molecules from the group of flavonoids gained a lot of interest over the past decades due to their antioxidant properties. Especially, epigallocatechin gallate was subjected to intensive research regarding its positive effects on human health. It

can be purchased as a dietary supplement but is also available in high amounts in green tea leaves. Here, we present an easy and time-saving method for the isolation of epigallocatechin gallate and other related catechins from a green tea extract based on the technique of mass-triggered fractionation.



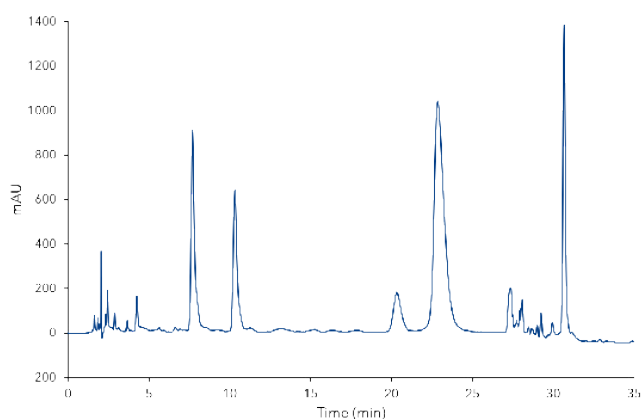
Structure of Epigallocatechin gallate (Catechin)

# Purification of epigallocatechin gallate and other related polyphenols from green tea by mass-triggered fractionation

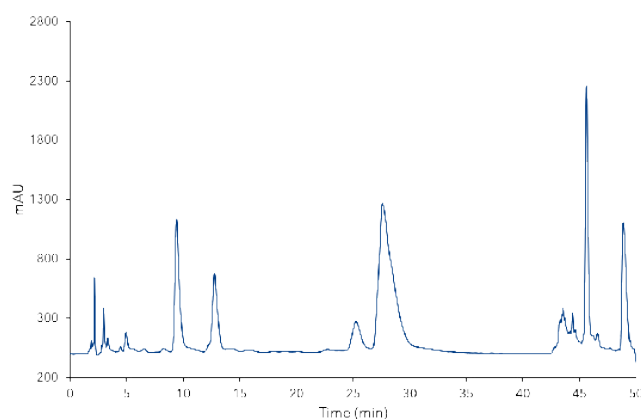
## RESULTS

A method for the isolation of epigallocatechin gallate from green tea extract was developed on analytical scale using an AZURA Analytical HPLC plus system and an Eurospher II C18 column (Fig. 1). The developed method was then transferred to the AZURA Preparative system with the ability to fractionate via molecular mass (Fig. 2). One fraction with the desired mass for epigallocatechin gallate ( $m/z$  457.4;  $[M-H]^-$ ) was collected (Fig. 3). In addition to this fraction, three further

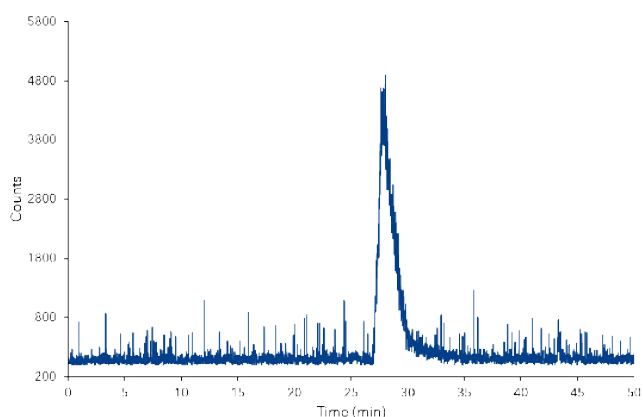
fractions corresponding to epicatechin, epicatechin gallate and epigallocatechin ( $m/z$  289.2;  $m/z$  305.2;  $m/z$  441.4;  $[M-H]^-$ ) were collected. The following HPLC analysis of the target fraction showed that it was possible to isolate epigallocatechin gallate with the technique of mass-triggered fractionation with a purity of >95 % (Fig. 4). Also, three other catechins were isolated by this method in the purity of >90 % (Fig. A1-A3).



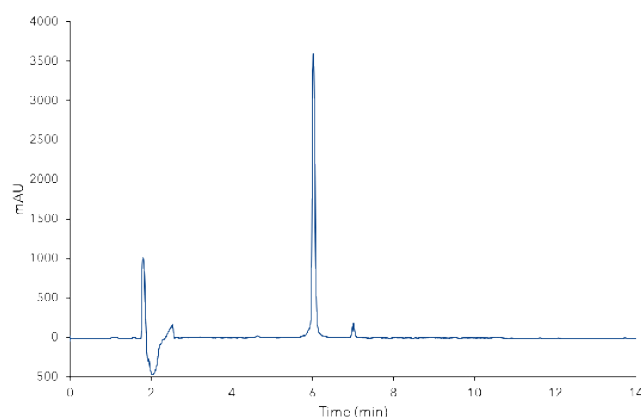
**Fig. 1** Analytical chromatogram of the crude green tea extract at 220 nm; step gradient separation 10 % acetonitrile until 26 min, then 15 % acetonitrile



**Fig. 2** UV chromatogram of a purification run for the crude green tea extract at 220 nm



**Fig. 3** SIM (single ion monitoring) chromatogram of a purification run for the target mass of  $m/z$  457.4



**Fig. 4** Analytical chromatogram of the third fraction containing epigallocatechin gallate ( $m/z$  457.4;  $[M-H]^-$ ); linear gradient separation 5 %-50 % acetonitrile

## MATERIALS AND METHOD

AZURA Analytical HPLC Plus system was used for the method development. Method optimization on this analytical system led to a step gradient, which was used for the isolation of polyphenols from green tea.

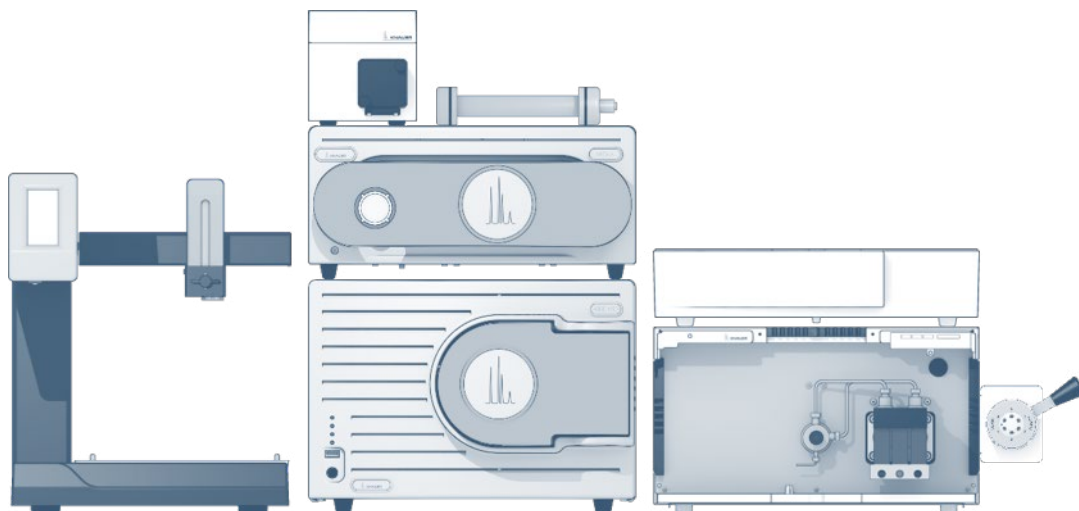
AZURA Preparative HPLC system was used for the mass-directed purification of epigallocatechin gallate. The system consisted of an AZURA P 2.1L pump equipped with a 250 mL pump head and a three channel low pressure gradient (LPG) ternary module, a manual injection valve (1/8", 6 port 2 position) equipped with a 5 mL sample loop, an AZURA UVD 2.1S detector equipped with a 3 mm flow cell, a 4000 MiD mass spectrometer with the MiDas sampling unit, a Foxy R1 fraction collector and an Eurospher II 100-5

C18 150 x 20 mm column. The step gradient method run for 50 min at a flow rate of 18.9 ml/min with the following composition: 0 min 10%B, 40 min 10%B, 40.1 15%B, 50 min 15%B, with 0.1% formic acid in water (A) and acetonitrile (B) as eluents. The wavelength of the detector was set to 220 nm at a data rate of 10 Hz, while the mass selective detector was set to negative SIM mode monitoring the masses of m/z 289.2, 305.2, 441.4, 457.4.

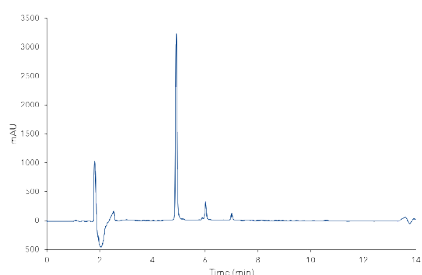
The green tea extract was prepared by sonification of ground green tea leaves with 75% ethanol for 60 min, followed by filtration and the dilution in a ration of 1:1 with water.

## CONCLUSION

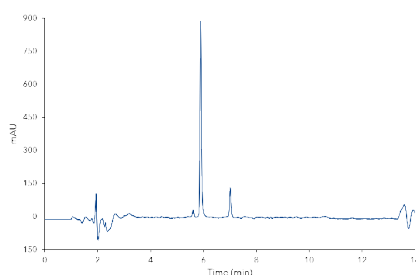
Epigallocatechin gallate is one of the major metabolites in green tea. This target molecule was isolated together with three other polyphenolic compounds in a short time with an AZURA Preparative HPLC system using the technique of mass-triggered fractionation. The number of fractions was reduced to a minimum by this technique leading to a significant decrease in past analysis time.



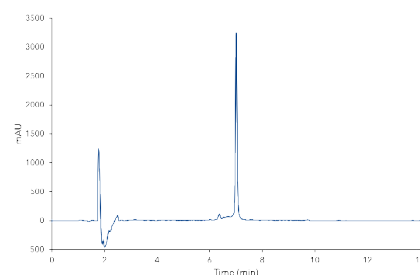
## ADDITIONAL RESULTS



**Fig. A1** Analytical chromatogram of the first fraction containing epigallocatechin (m/z 305.2; [M-H]); linear gradient separation 5%-50% acetonitrile.



**Fig. A2** Analytical chromatogram of the second fraction containing epicatechin (m/z 289.2; [M-H]); linear gradient separation 5%-50% acetonitrile.



**Fig. A3** Analytical chromatogram of the fourth fraction containing epicatechin gallate (m/z 441.4; [M-H]); linear gradient separation 5%-50% acetonitrile.

## ADDITIONAL MATERIALS AND METHODS

**Tab. A1** Method parameters (preparative)

Eluent A	Water + 0.1% formic acid		
Eluent B	Acetonitrile		
Gradient	Time (min)	%A	%B
	0	90	10
	40	90	10
	40.1	85	15
	50	85	15
Flow rate	18.9 mL/min	System pressure	120 bar
Column temperature	RT	Run time	50 min
Injection volume	500 µL	Injection mode	-
Detection wavelength	220 nm	Data rate	10 Hz
		Time constant	0.1 sec

**Tab. A3** System configuration & data (analytical system)

Instrument	Description	Article No.
Pump	AZURA P 6.1L	<a href="#">APH34GA</a>
Autosampler	AZURA AS 6.1L	<a href="#">AAA00AA</a>
Detector	AZURA DAD 2.1L	<a href="#">ADC01</a>
Flow cell	PressureProof flow cell 10 mm, 10 µl	<a href="#">AMC38</a>
Column	Eurospher II 100-5 C18 with precolumn, Vertex Plus Column 150 x 4.6 mm	<a href="#">15VE181E2J</a>
Software	ClarityChrom	<a href="#">A1670</a>
	ClarityChrom 8.1 - PDA extension	<a href="#">A1676</a>

**Tab. A2** Method parameters (mass spectrometer)

Scan mode	SIM (Single Ion Monitoring)
Scan rate	1 Hz
Step	0.2
SIM	289.2 m/z, 305.2 m/z, 441.4 m/z, 457.4 m/z
Ion mode	Negative
Gas flow	2.5 l/min

**Tab. A4** System configuration & data (preparative system)

Instrument	Description	Article No.
Pump	AZURA P 2.1L	<a href="#">APE20LA</a>
	AZURA LPG module for Pump P 2.1L	<a href="#">AZZ00AB</a>
Injection	AZURA V 2.1	<a href="#">A1359</a>
Sample loop	5 ml sample loop	<a href="#">A0586-2</a>
Detector	AZURA UVD 2.1S	<a href="#">ADA00</a>
Flow cell	Semi-preparative UV flow cell 3 mm, 2 µl	<a href="#">A4042</a>
Mass spectrometer	4000 MiD with MiDas	<a href="#">A66900</a>
Fractionation	Fraction collector Foxy R1	<a href="#">A59100</a>
Column	Eurospher II 100-5 C18, Column 150x20 mm	<a href="#">15JE181E2J</a>
Software	PurityChrom 5.9.69	<a href="#">A2650</a>
	PurityChrom Upgrade to full version	<a href="#">A2652</a>
	PurityChrom MS license	<a href="#">A2655</a>

## RELATED KNAUER APPLICATIONS

[VPH0067](#) - Easy and fast isolation of rosmarinic acid from lemon balm with mass-directed purification



# Quick and easy determination of aflatoxins in food matrices with photochemical post column derivatization

Kristin Folmert, Mareike Margraf, Kate Monks - applications@knauer.net  
KNAUER Wissenschaftliche Geräte GmbH,  
Hegauer Weg 38, 14163 Berlin - www.knauer.net



## SUMMARY

One of the 10 most dangerous chemicals in the world is the aflatoxin B1. For both, humans and animals the consumption of the toxic aflatoxins can lead to serious health damage. They are produced by mold fungi on food and feed products. Herewith, a simple, robust and highly sensitive method for the analysis of aflatoxins in food and feed is provided to ensure consumer safety.

## INTRODUCTION

Aflatoxins are the best known group of mycotoxins produced as secondary metabolites by fungi, mainly by *Aspergillus flavus* and *Aspergillus parasiticus*, but to a smaller extent also by other strains. [1] Aflatoxins can be produced on crops in the field or during storage of agricultural products, especially under warm conditions and high humidity. Aflatoxins also pose a significant economic burden, causing an estimated 25 % or more of the world's food crops to be destroyed annually. [2] Unfortunately, these substances can persist long after the fungi have been killed and thereby contaminate foods. Most mycotoxins are stable compounds that are also not destroyed during food processing or cooking. Although a large number of aflatoxins exist only a limited number is important in analytical practice. Aflatoxin B1 is most widespread and can be found in food and feed products such as peanuts, pistachios, corn and cottonseed, dried fruits, and all processed products. It is highly toxic and the WHO classified it as a group 1 carcinogen. [2] The aflatoxins B2, G1, and G2 are usually found accompanying B1 in lower concentrations in the contaminated

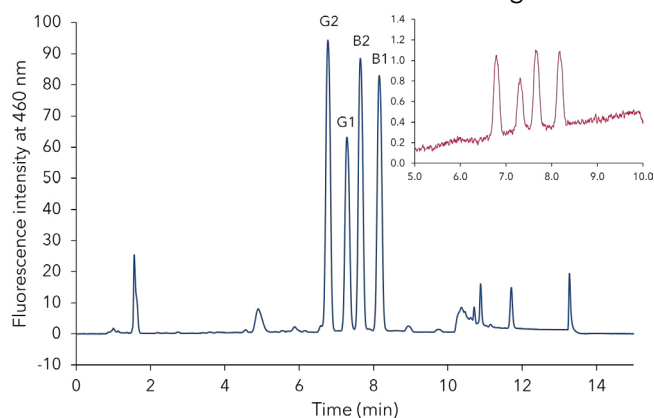
samples (**Fig. 1**). Governmental institutions and health protection agencies like FDA, WHO and European Commission apply these methods on a large scale to control marketed food products and animal feed. [2, 3, 4] Additionally, the presence of aflatoxins B1, B2, G1, and G2 in a variety of processed and unprocessed foods is controlled in countries around the world. 0.1 µg/kg processed cereal-based foods and all kinds of dietary foods for special medical purpose, both for babies, infants and young children is the lowest maximum aflatoxin level set by the European Commission according to regulation EG 1881/2006. [5] The required verification method is HPLC with fluorescence detection and preliminary sample extraction described in the KNAUER application notes VFD0179-VFD0182. Unfortunately, Aflatoxins B1 and G1 show only minimal fluorescence and are thus difficult to detect. Irradiating the aflatoxin mixture with UV light of 254 nm, the aflatoxins B1 and G1 undergo photo-induced hydroxylation and can then be measured through fluorescence spectrometry more sensitively.



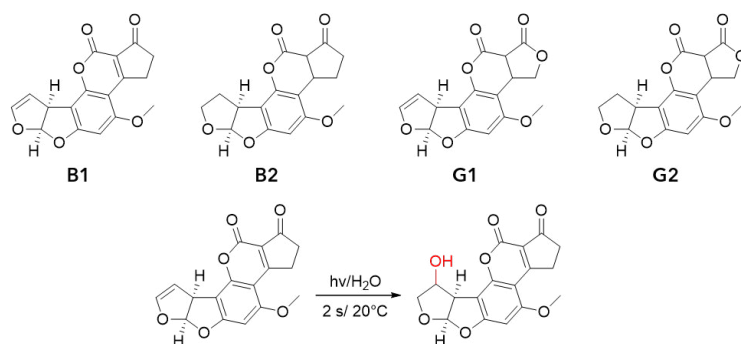
# Quick and easy determination of aflatoxins in food matrices with photochemical post column derivatization

## RESULTS

For the method development of an universally usable aflatoxin HPLC method an equal mixture of food extracts was produced. The mixture contained extracts from different nuts, dried fruits, and cereal baby food products. Nuts are the most often affected source of aflatoxins, while dried fruits are the most difficult matrix for the analysis. Cereal puree and rusk for babies are prominent examples for the food group with lowest accepted action levels defined by the European Commission. The resulting gradient method takes 9 minutes followed by a 6 minute long column cleaning and equilibration step (Fig. 2). The resulting peak resolution for the aflatoxin peaks was higher than 1.5 and all matrix peaks could be separated. The determined limits of detection (LOD) were 0.05 ng/mL for aflatoxins B1/G1 and 0.015 ng/mL for B2/G2 (Fig. 3). These values are 3.4 and 11.3 times lower than requested by the European Commission [5]. To evaluate the quality of the developed method, the recovery (W), the standard deviation (RSD), and the robustness were established. The recovery ratios were determined with three repetitions at three concentration levels. The used limits were the limit of qualification (LOQ), twice the LOQ and 20 ng/mL. The results in Tab. 1 are an average of the three concentration limits. At the high level the

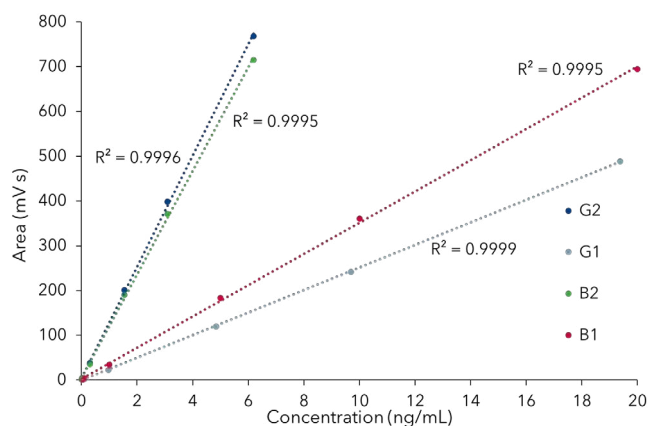


**Fig. 2** Chromatogram of a mixture including equal parts of extraction products from peanuts, pistachios, cereal puree and rusk for babies and dried fruits (cherries, cranberries, raisins, aronia, and plums) spiked with 20 ng/mL of the aflatoxins B1/G1 and 6 ng/mL B2/G2 (blue). Zoom into a chromatogram of a standard mixture of the four aflatoxins at the LOQ (red).

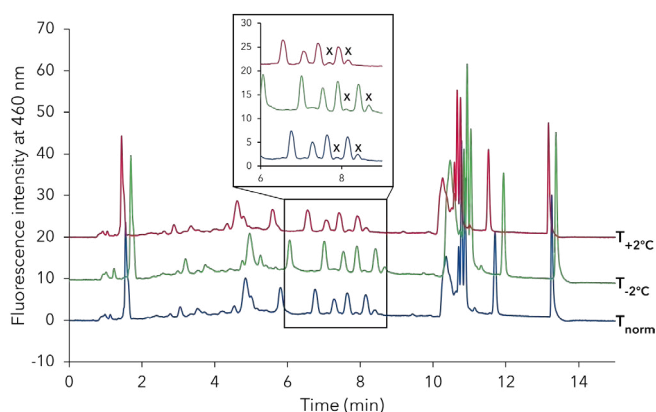


**Fig. 1** Chemical structures of the four aflatoxins and the reaction mechanism of the photochemical activation

recovery was around 100 % with decreasing quality for the very low concentrations, which is reasonable due to the volume of the derivatization reaction coil. For the standard deviation 8 identical repetitions with 1 ng/mL of an aflatoxine standard mixture were measured (Tab. 2). The RSD was lower 0.1 % for the retention times and lower 0.5 % for the peak area and height. For robustness evaluation a variation of the method parameters was performed (Tab. 3). The method was assumed to be robust if all matrix peaks and the four aflatoxin peaks were baseline separated from each other. The developed aflatoxin method resulted to be very robust against changes in temperature, flow rate and the eluent mixture during the gradient.



**Fig. 3** Concentration curves for the four aflatoxins with correlation coefficient. The empiric determined LOD for the aflatoxins B1/G1 was 0.05 ng/mL and for B2/G2 0.015 ng/mL.



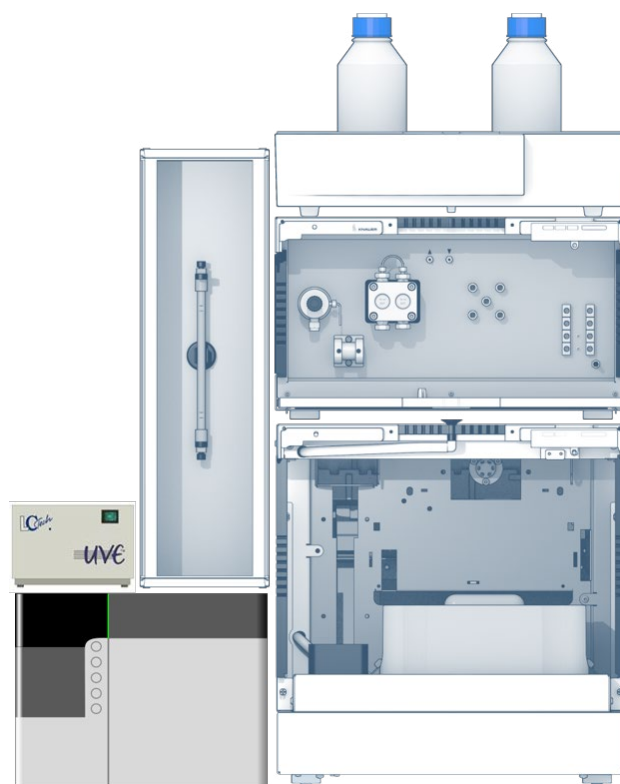
**Fig. 4** Example of three chromatograms with 1.0 ng/mL aflatoxin B1/G1 and 0.3 ng/mL B2/G2 measured for robustness validation. The method was robust if the two labeled matrix peaks were baseline separated from the aflatoxin peaks.

## MATERIALS & METHODS

The dedicated AZURA® Aflatoxin system consisted of a low pressure gradient AZURA P 6.1L pump, an AZURA autosampler AS 6.1L, an AZURA CT 2.1 column thermostat, and an RF-20A fluorescence detector with coupled photochemical post column derivatization module. The photochemical post column derivatization enables a non-toxic and fast derivatization at room temperature. In comparison to previous methods, using saturated iodine reaction coils or with electrochemical generated bromine in a KOBRA cell, no toxic halogenic reagents were used for derivatization. Thus, no halogenic solvent waste was produced. The column was a temperature and mechanical robust Eurospher II C18 100-3 column. The sample preparation was performed with liquid-liquid and solid phase extraction as described in the KNAUER application notes [VFD0179](#), [VFD0180](#), [VFD0181](#), and [VFD0182](#).

## REFERENCES

- [4] M.T. Hedayati, A.C. Pasqualotto, P. Bowyer, D.W. Denning, *Microbiology* 2007 (153) 6, 1677-1692. doi: 10.1099/mic.0.2007/007641-0
- [5] World Health Organization, Food Safety Digest - Aflatoxins, Department of Food Safety and Zoonoses 2018, Ref. No.: WHO/NHM/FOS/RAM/18.1.
- [6] U.S. Department of Health and Human Services, Food and Drug Administration, Sec.683.100 Action Levels for Aflatoxins in Animal Food 2019.
- [7] Die Europäische Gemeinschaft, Verordnung (EG) Nr. 401/2006 Der Kommission - Zur Festlegung der Probennahmeverfahren und Analysemethoden für die amtliche Kontrolle des Mykotoxingehalts von Lebensmitteln 2016.
- [8] The European Commission, Commission Regulation (EC) No 1881/2006 of 19 December 2016 - Setting maximum levels for certain contaminants in foodstuffs, *Official Journal of the European Union*, 2006, L 364/5 - L 364/24.



## DISCUSSION

Using the UVE photochemical reactor for post column derivatization in combination with the AZURA Analytical HPLC system and Eurospher II C18 column, it was possible to detect the four aflatoxins B1, B2, G1 and G2 in one chromatographic run with the very low LOD of 0.05 ng/mL for B1/G1 and 0.15 ng/mL for B2/G2. The high robustness and reproducibility of the method were confirmed by empirical quality control. Furthermore, the handling of the photochemical reactor was very easy because no further chemicals were required for derivatization.

## ADDITIONAL RESULTS

**Tab. A1** Averaged recovery ratios measured at LOQ, twice LOQ and 20 ng/mL aflatoxin

Aflatoxin	W (%)
B1	80 ± 6
B2	78 ± 5
G1	87 ± 7
G2	84 ± 6

**Tab. A2** Standard deviation (RSD) of 8 repetitions at the same conditions

Parameter	RSD (%)
Retention time	< 0.1
Peak area	< 0.5
Peak height	< 0.5

**Tab. A3** Robustness of the method

Parameter	Robust range
Temperature	± 2°C
Flow rate	± 0.2 mL/min
tG ACN	± 2%
tG MeOH	± 2%
tG H <sub>2</sub> O	± 2%

## ADDITIONAL MATERIALS AND METHODS

**Tab. A4** Instrument setup

Column temperature	60°C	Time constant	0.1 s
Injection volume	10 µL	Excitation	365 nm
Injection mode	Full Loop	Emission	460 nm
Detection	FLD	Post column derivatization	254 nm
Data rate	50 Hz	Flow rate	2.4 mL/min

**Tab. A5** Pump program

Time (min)	Water (%)	ACN (%)	MeOH (%)
0	83.0	5.0	12.0
0.5	83.0	5.0	12.0
9.0	54.0	34.0	12.0
9.1	0.0	100.0	0
12.0	0.0	100.0	0
12.1	83.0	5.0	12.0
15.0	83.0	5.0	12.0

**Tab. A6** System configuration

Instrument	Description	Article No.
Pump	AZURA P6.1L, LPG	<a href="#">APH39EA</a>
Autosampler	AZURA AS 6.1L	<a href="#">AAA00AA</a>
Fluorescence detector	RF-20A	<a href="#">A59200</a>
Thermostat	AZURA CT 2.1	<a href="#">A05852</a>
Column	Eurospher II C18 100-3 150-4.6 mm	<a href="#">15EE181E2G</a>
Post column derivatization	UVE Box, 50 Hz	<a href="#">A07547</a>
Interface box	IFU 2.1 Lan	<a href="#">AZB00XA</a>
Software	ClarityChrom 8.1	<a href="#">A1670</a>

## RELATED APPLICATIONS

[VFD0179](#) - Determination of Aflatoxines in Peanut Samples - From Extraction to High Efficient Detection

[VFD0180](#) - Determination of Aflatoxines in Pistachio Samples - From Extraction to High Efficient Detection

[VFD0181](#) - Determination of Aflatoxines in Dried Fruit Samples - From Extraction to High Efficient Detection

[VFD0182](#) - Determination of Aflatoxines in Cereal Baby Food Samples - From Extraction to High Efficient Detection

# Determination of aflatoxins in peanut samples - from extraction to high efficient detection



Kristin Folmert, Kate Monks; applications@knauer.net

KNAUER Wissenschaftliche Geräte GmbH, Hegauer Weg 38, 14163 Berlin; www.knauer.net.

In Kooperation mit Macherey Nagel, LCTech GmbH

## SUMMARY

Cultivation, drying and storage of peanuts may contribute to the spread of molds, which produce mycotoxins – toxic secondary metabolites. Their consumption can lead to serious health damage. To ensure consumer safety it is inevitable to provide a simple, robust and exact method for the analysis of mycotoxins in food, especially the most often occurring aflatoxins. In this application note the sample extraction for peanuts as preparation for a highly sensitive HPLC method is described.

## INTRODUCTION

Aflatoxins are the best known group of mycotoxins produced as secondary metabolites by fungi, mainly by *Aspergillus flavus* and *Aspergillus parasiticus*, but to a smaller extent also by other strains<sup>1</sup>. Aflatoxins can be produced on legumes like peanuts in the field or during storage, especially under warm conditions and high humidity. Thus, the infection with *Aspergillus* species most often occurs during the dehydration process. Since peanuts are mostly cultivated and consumed in countries of the developing world with lower hygiene standards in the south of Africa and South America, the dehydration is often realized on bare mats in the sun causing an *Aspergillus flavus/parasiticus* contamination in a range of 3-20% of all produced kernels<sup>2</sup>. Aflatoxins are stable compounds that are not destroyed during food processing like the typical roasting of the peanuts or cooking. As a consequence, also products made from peanuts can contain aflatoxins. In 2014 91% of all tested peanut butter samples produced

in Zimbabwe where contaminated with aflatoxins<sup>2</sup>. Although many aflatoxins exist, only a limited number is important in analytical practice. Aflatoxin B1 is most widespread and can be found in food and feed products such as peanuts, pistachios, corn and cottonseed, dried fruits and all processed products. It is highly toxic and the WHO classified it as a group 1 carcinogen<sup>3</sup>. The aflatoxins B2, G1, and G2 are usually found accompanying B1, in lower concentrations in the contaminated samples (Fig. 1). Governmental institutions and health protection agencies like FDA, WHO and European Commission apply these methods on a large scale to control marketed food products and animal feed<sup>3,4,5</sup>. Additionally, the presence of aflatoxins B1, B2, G1, and G2 in a variety of processed and unprocessed foods is controlled in countries around the world. The lowest maximum aflatoxin level of 0.1 µg/kg for processed cereal-based foods and all kinds of dietary foods for special medical purpose, both for babies, infants and young children are set by



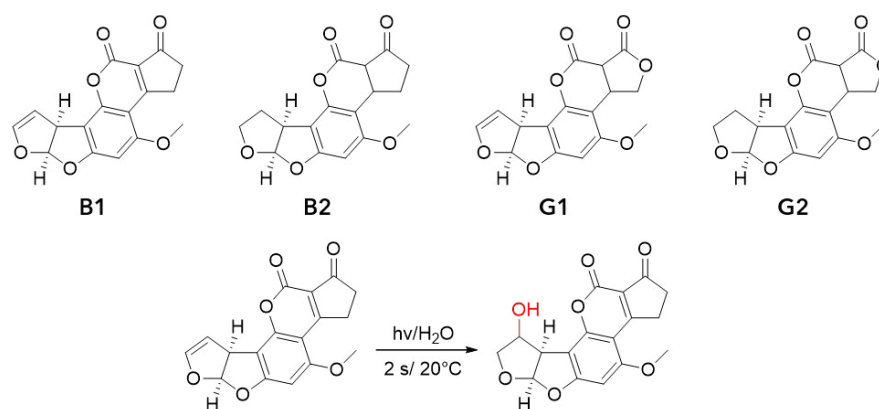
Additional Information

# Determination of aflatoxins in peanut samples - from extraction to high efficient detection

## INTRODUCTION

the European Commission according to regulation EG 1881/2006<sup>6</sup>. The required verification method is HPLC with fluorescence detection and preliminary sample extraction. Unfortunately, aflatoxins B1 and G1 show only minimal fluorescence and are thus difficult to detect. Irradiating the aflatoxins mixture with UV light of 254 nm, the aflatoxins B1 and G1 undergo photo-induced hydroxylation and can then be measured through fluorescence spectrometry more sensitively. The dedicated AZURA® Aflatoxin system consists of a fluorescence detector with coupled photochemical post column derivatization module. The photochemical post column derivatization enables a non-toxic and

fast derivatization at room temperature. In comparison to previous methods, using saturated iodine reaction coils or with electrochemical generated bromine in a KOBRA cell, no toxic halogenic reagents were used for derivatization. Thus, no halogenic solvent waste was produced. The complete analytical method, including recovery, standard deviation and robustness evaluation, is described in AppNote [VFD0178](#)<sup>7</sup>. The sample preparation for the analytical method described in this AppNote is suitable to reduce intensive matrix effects to enable a highly reproducible and sensitive quantification of the aflatoxins.



**Fig. 1** Chemical structures of the four aflatoxins and the reaction mechanism of the photochemical activation.

## RESULTS

The sample preparation for the analytical aflatoxin study is based on three different extraction steps. During the first solid-liquid extraction aflatoxins can be extracted together with many other soluble compounds, removing most of the solid peanut material. The extracts contain a high concentration of matrix with fluorescence intensity up to 900 counts (Fig. 2A). During the liquid-liquid extraction most fatty and hydrophobic compounds could be removed leaving fluorescence matrix peaks up to 8 counts (Fig. 2B). Most of the resulting matrix peaks, especially in the critical time between 6 and 9 minutes where the aflatoxins can be detected, could be removed

during SPE extraction (Fig. 2C). The two resulting peaks with higher fluorescence intensity up to 25 counts correspond to the solvents chloroform and acetone. With almost all matrix peaks removed, a highly sensitive and robust aflatoxin analysis can be assured. In Fig. 3 a various mixture of different food sample extractions spiked with 20 ng/mL of the aflatoxins B1/G1 and 6 ng/mL B2/G2 was analyzed (blue). The determined limits of detection (LOD) were 0.05 ng/mL for aflatoxins B1/G1 and 0.015 ng/mL for B2/G2 (Fig. 3, red). These values are 3.4 and 11.3 times lower than requested from the European Commission<sup>6</sup>.

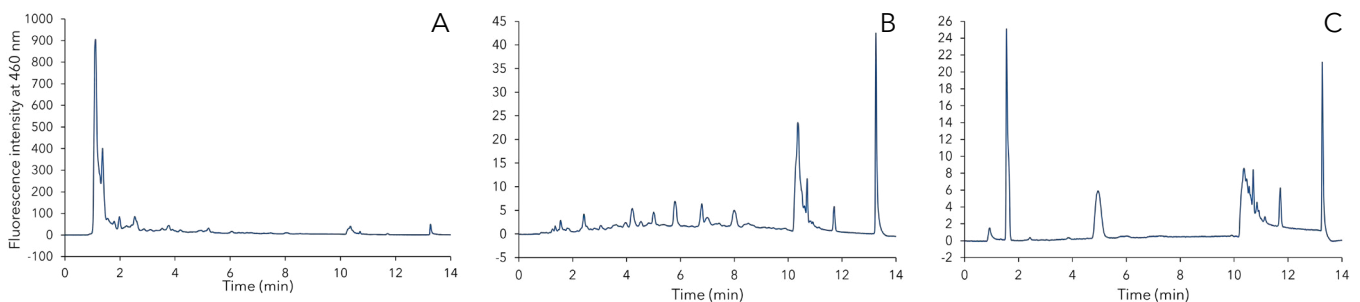


Fig. 2 Three different samples during extraction process. After the extraction with MeOH/H<sub>2</sub>O (A), before SPE (B) and after the SPE extraction (C).

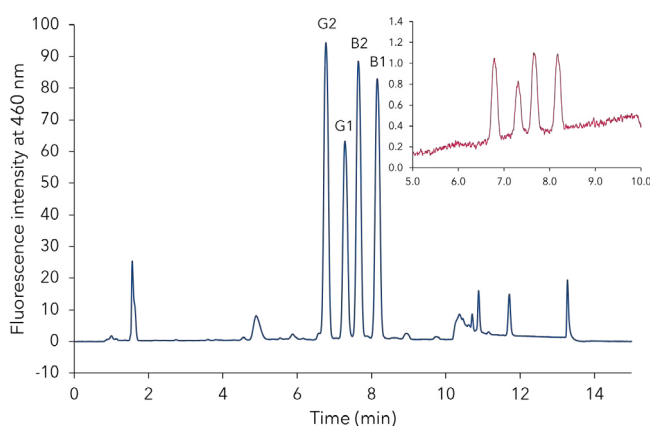


Fig. 3 Chromatogram of a mixture including equal parts of extraction products from peanuts, pistachios, cereal puree for babies and dried fruits (cherries, cranberries, raisins, aronia and plums) spiked with 20 ng/mL of the aflatoxins B1/G1 and 6 ng/mL B2/G2 (blue). Zoom into a chromatogram of a standard mixture of the four aflatoxins at the LOQ (red).

# Determination of aflatoxins in peanut samples - from extraction to high efficient detection

## SAMPLE PREPARATIONS

For sample preparation 50 g of commercially available peanuts without shell were grinded to a fine powder before suspending them with 20 mL MeOH:H<sub>2</sub>O (17:3, v/v) for 30 minutes. The suspension was filtered, and 40 mL of the extract were filled into an extraction funnel. The extract was degreased two times with 25 mL *n*-hexane and the aqueous phase was extracted two times with 25 mL chloroform. The organic extract was evaporated to 3 mL before SPE extraction. The SPE cartridges were provided by Macherey Nagel and filled with 3 mL SiOH with a specific loading capacity of 500 mg. The SPE cartridge was conditioned with 3 mL *n*-hexane followed by 3 mL chloroform before the

extract was added. The bounded compounds from the extract, including the aflatoxins, were washed with *n*-hexane, diethyl ether and chloroform, 3 mL each. After washing, the collecting template was changed and the bounded compounds were removed by rinsing the SPE cartridge with 6 mL chloroform:acetone (9:1, v/v). The final extract was stored in a gas tight glass flask. The sample preparation was performed in three identical replicates to evaluate the reproducibility of the method. During sample preparation an analytical sample was collected after the extraction with MeOH/H<sub>2</sub>O, before and after the SPE extraction to verify the success of the extraction step.

## CONCLUSION

The described sample preparation for the extraction of aflatoxins from peanuts can be used for all kind of food and animal feed which could be affected by aflatoxins. Analytical control samples after every extraction step could verify that the sample preparation is very efficient for the reduction of matrix peaks. Additionally, using the UVE photochemical reactor for post column derivatization in combination with the AZURA Analytical HPLC system and Eurospher II C18 column, it was possible to detect the four aflatoxins B1, B2, G1 and G2 in one chromatographic run of a spiked sample with the very low LOD of 0.05 ng/mL for B1/G1 and 0.015 ng/mL for B2/G2.



## MATERIALS AND METHODS

**Tab. 1** Instrument setup

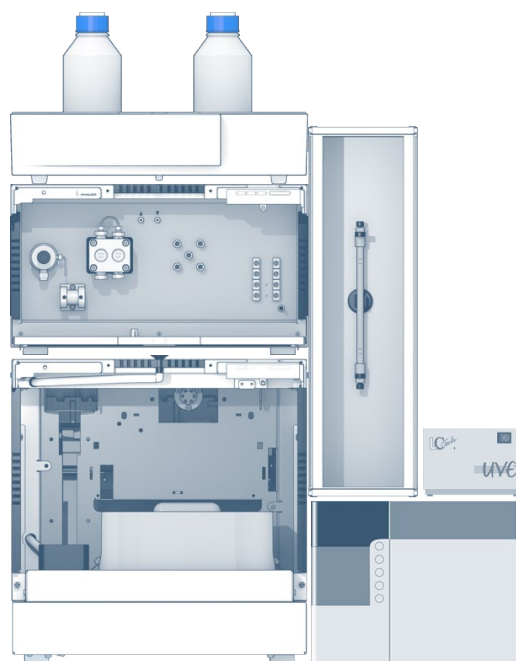
Column temperature	60 °C	Time constant	0.2 s
Injection volume	10 µL	Excitation	365 nm
Injection mode	Full Loop	Emission	460 nm
Detection	FLD	Post column derivatization	254 nm
Data rate	50 Hz	Flow rate	2.4 mL/min

**Tab. 2** Pump program

Time (min)	Water (%)	ACN (%)	MeOH (%)
0.0	83	5	12
0.5	83	5	12
9.0	54	34	12
9.1	0	100	0
12.0	0	100	0
12.1	83	5	12
15.0	83	5	12

**Tab. 3** System configuration

Instrument	Description	Article No.
Pump	AZURA P6.1L, LPG	<a href="#">APH34EA</a>
Autosampler	AZURA AS 6.1L	<a href="#">AAA00AA</a>
Fluorescence detector	RF-20A	<a href="#">A59200</a>
Thermostat	AZURA CT 2.1	<a href="#">A05852</a>
Column	Eurospher II 100-3 C18, 150 x 4.6 mm ID	<a href="#">15EE181E2G</a>
Post column derivatization	UVE Box, 50 Hz	<a href="#">A07547</a>
Interface box	IFU 2.1 Lan	<a href="#">AZB00XA</a>
Software	ClarityChrom 8.1	<a href="#">A1670</a>



## REFERENCES

- [9] Hedayati, M. T., Pasqualotto, A. C., Bowyer P., Denning, D. W. *Aspergillus flavus*: human pathogen, allergen and mycotoxin producer. *Microbiology* 153 (6), 1677-1692 (2007).
- [10] Mupunga, I., Lebelo, S. L., Mnggawa, P., Rheeder, J. P., Katerere, D. R. Natural occurrence of aflatoxins in peanuts and peanut butter from Bulawayo, Zimbabwe. *J. Food Prot.* 77(10), 1814-1818 (2014).
- [11] World Health Organization (WHO) Aflatoxins. Food safety digest, Department of food safety and zoonoses. Ref. No.: WHO/NHM/FOS/RAM/18.1 (2018).
- [12] U.S. Department of Health and Human Services, Food and Drug Administration (FDA) Action levels for aflatoxins in animal food. CPG Sec. 683.100 (2019).
- [13] The European Commission, Commission Regulation (EC) No 401/2006 of 23 February 2006 laying down the methods of sampling and analysis for the official control of the levels of mycotoxins in foodstuffs (2016).
- [14] The European Commission, Commission Regulation (EC) No 1881/2006 of 19 December 2006 setting maximum levels for certain contaminants in foodstuffs (2006).
- [15] Folmert, K., Margraf, M., Monks, K. Quick and easy determination of aflatoxins in food matrices with photochemical postcolumn derivatization. *KNAUER, AppNote VFD0178*, 1-4 (2019).

## RELATED KNAUER APPLICATIONS

[VFD0152](#) - Determination of Aflatoxin M1 in milk

[VFD0175](#) - Verification of the mycotoxin patulin from apple juice with isocratic HPLC

[VFD0178](#) - Quick and easy determination of aflatoxins in food matrices with photochemical post column derivatization

[VFD0180](#) - Determination of aflatoxines in pistachio samples - from extraction to high efficient detection

[VFD0181](#) - Determination of aflatoxines in dried fruit samples - from extraction to high efficient detection

[VFD0182](#) - Determination of aflatoxines in cereal baby food samples - from extraction to high efficient detection

# Determination of aflatoxins in pistachio samples - from extraction to high efficient detection



Kristin Foltmeyer, Kate Monks; applications@knauer.net

KNAUER Wissenschaftliche Geräte GmbH, Hegauer Weg 38, 14163 Berlin; www.knauer.net.

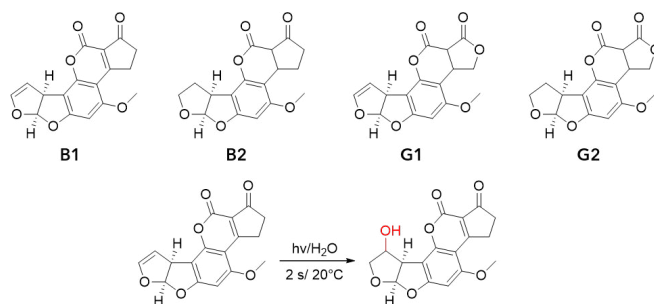
## SUMMARY

Cultivation and storage of nuts like pistachios may contribute to the spread of molds, which produce mycotoxins – toxic secondary metabolites. Their consumption can lead to serious health damage. To ensure consumer safety it is inevitable to provide a simple, robust, and exact method for the analysis of mycotoxins in food, especially the most often occurring aflatoxins. In this application the sample extraction for pistachios as preparation for a highly sensitive HPLC method is described.

## INTRODUCTION

Aflatoxins are the best known group of mycotoxins produced as secondary metabolites by fungi, mainly by *Aspergillus flavus* and *Aspergillus parasiticus*<sup>1</sup>. Aflatoxins can be produced on nuts like pistachios in the field or during storage, especially under warm conditions and high humidity. Many *Aspergillus* species infect nuts and cause decay of the kernels before harvest. Pistachios are a particular endangered case because the shells of these nuts splits naturally prior to harvest, thus leaving the nuts poorly protected from molds. As a result, pistachios are the main source of human dietary aflatoxins from tree nuts worldwide, accounting for 7-45 % of humans' total aflatoxin exposure from all sources<sup>2</sup>. Most mycotoxins are stable compounds that are not destroyed during food processing or cooking. Although many aflatoxins exist, only a limited number is important in analytical practice. Aflatoxin B1 is most widespread and can be found in food and feed products such as peanuts, pistachios, corn and cottonseed, dried fruits and all processed products. It is highly toxic and the WHO classified it as a group 1 carcinogen<sup>3</sup>. The aflatoxins B2, G1, and G2 are usually

found accompanying B1, in lower concentrations in the contaminated samples (Fig. 1).



**Fig. 1** Chemical structures of the four aflatoxins and the reaction mechanism of the photochemical activation.

Governmental institutions and health protection agencies like FDA, WHO and European Commission apply these methods on a large scale to control marketed food products and animal feed<sup>3,4,5</sup>. Additionally, the presence of aflatoxins B1, B2, G1, and G2 in a variety of processed and unprocessed foods is controlled in countries around the world. The lowest maximum aflatoxin level of 0.1 µg/kg for processed cereal-based foods and all kinds of dietary foods for special medical purpose, both for babies, infants and



Additional Information

# Determination of aflatoxins in pistachio samples - from extraction to high efficient detection

## INTRODUCTION

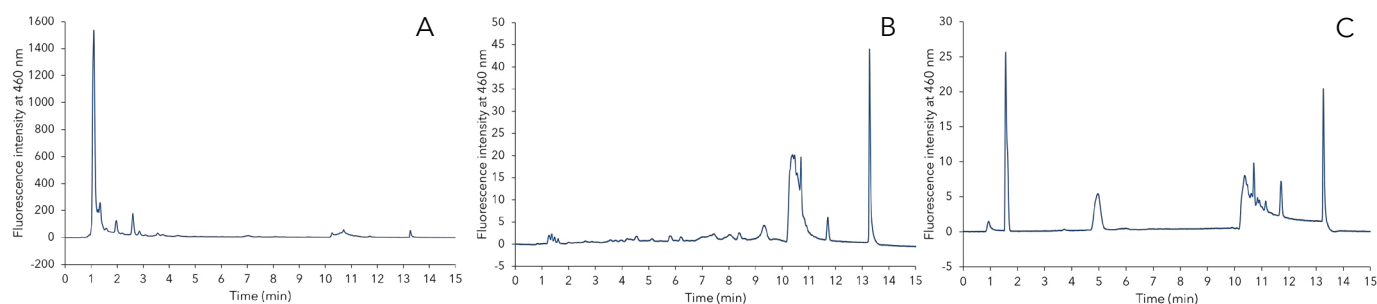
young children are set by the European Commission according to regulation EG 1881/2006<sup>6</sup>. The required verification method is HPLC with fluorescence detection and preliminary sample extraction. Unfortunately, aflatoxins B1 and G1 show only minimal fluorescence and are thus difficult to detect. Irradiating the aflatoxins mixture with UV light of 254 nm, the aflatoxins B1 and G1 undergo photo-induced hydroxylation and can then be measured through fluorescence spectrometry more sensitively. The dedicated AZURA® Aflatoxin system consists of a fluorescence detector with coupled photochemical post column derivatization module. The photochemical post column derivatization

enables a non-toxic and fast derivatization at room temperature. In comparison to previous methods, using saturated iodine reactions coils or with electrochemical generated bromine in a KOBRA cell, no toxic halogenic reagents were used for derivatization. Thus, no halogenic solvent waste was used. The complete analytical method, including recovery, standard deviation, and robustness evaluation, is described in AppNote [VFD0178](#)<sup>7</sup>. The sample preparation for the analytical method described in this AppNote is suitable to reduce intensive matrix effects to enable a highly reproducible and sensitive quantification of the aflatoxins.

## RESULTS

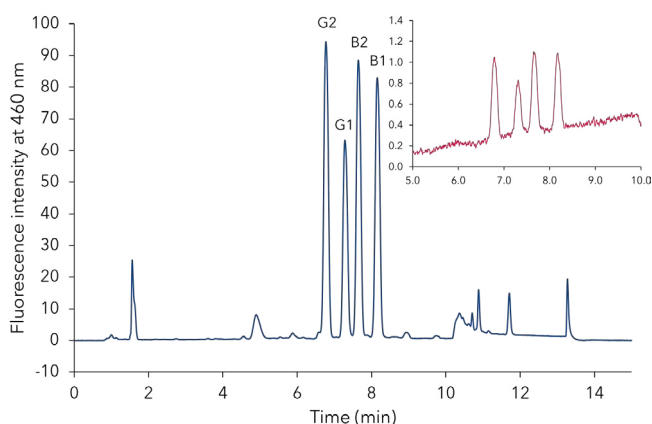
The sample preparation for the analytical aflatoxin analysis is based on three different extraction steps. During the first solid-liquid extraction aflatoxins can be extracted together with many other soluble compounds, removing most of the solid pistachio material. The extracts contain a high concentration of matrix with fluorescence intensity up to 1600 counts (**Fig. 2A**). During the liquid-liquid extraction most fatty and hydrophobic compounds could be removed leaving fluorescence matrix peaks up to 45 counts (**Fig. 2B**). Most of the resulting matrix peaks, especially in the critical time between six and nine minutes where the aflatoxins can be detected,

could be removed during SPE extraction (**Fig. 2C**). The two resulting peaks with higher fluorescence intensity up to 25 counts correspond to the solvents chloroform and acetone. With almost all matrix peaks removed, a highly sensitive and robust aflatoxin analysis can be assured. In **Fig. 3** a various mixture of different food sample extractions spiked with 20 ng/mL of the aflatoxins B1/G1 and 6 ng/mL B2/G2 was analyzed (blue). The determined limits of detection (LOD) were 0.05 ng/mL for aflatoxins B1/G1 and 0.015 ng/mL for B2/G2 (**Fig. 3**, red). These values are 3.4 and 11.3 times lower than requested from the European Commission<sup>6</sup>.



**Fig. 2** Three different samples during extraction process. After the extraction with MeOH/H<sub>2</sub>O (A), before SPE (B) and after the SPE extraction (C).

## RESULTS



**Fig.3** Chromatogram of a mixture including equal parts of extraction products from peanuts, pistachios, cereal puree for babies and dried fruits (cherries, cranberries, raisins, aronia and plums) spiked with 20 ng/mL of the aflatoxins B1/G1 and 6 ng/mL B2/G2 (blue). Zoom into a chromatogram of a standard mixture of the four aflatoxins at the LOQ (red).

## SAMPLE PREPARATIONS

For sample preparation 50 g of commercially available pistachio nuts without shell were grinded to a fine powder before suspending them with 20 mL MeOH:H<sub>2</sub>O (17:3, v/v) for 30 minutes. The suspension was filtered and 40 mL of the extract were filled into an extraction funnel. The extract was degreased two times with 25 mL *n*-hexane and the aqueous phase was extracted two times with 25 mL chloroform. The organic extract was evaporated to 3 mL before SPE extraction. The SPE cartridges were provided by Macherey Nagel and filled with 3 mL SiOH with a specific loading capacity of 500 mg. The SPE cartridge was conditioned with 3 mL hexane followed by 3 mL chloroform before the

extract was added. The bounded compounds from the extract, including the aflatoxins, were washed with *n*-hexane, diethyl ether, and chloroform 3 mL each. After washing the collecting template was changed and the bounded compounds were removed by rinsing the SPE cartridge with 6 mL chloroform:acetone (9:1, v/v). The final extract was stored in a gas tight glass flask. The sample preparation was performed in three identical replicates to evaluate the reproducibility of the method. During sample preparation an analytical sample was collected after the extraction with MeOH/H<sub>2</sub>O, before and after the SPE extraction to verify the success of the extraction step.

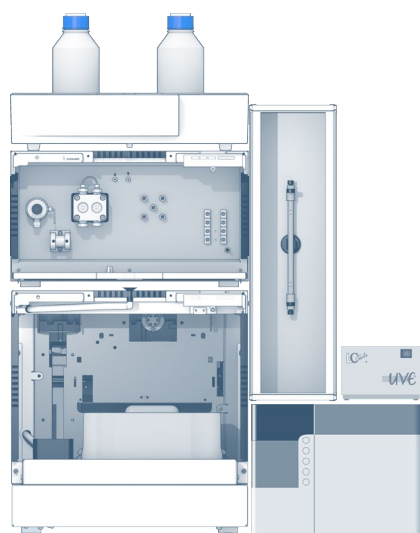
## CONCLUSION

The described sample preparation for the extraction of aflatoxins from pistachios can be used for all kind of food and animal feed which could be affected by aflatoxins. Analytical control samples after every extraction step could verify that the sample preparation is very efficient for the reduction of matrix peaks. Additionally, using the UVE photochemical reactor for post column derivatization in combination with the AZURA Analytical HPLC system and Eurospher II C18 column, it was possible to detect the four aflatoxins B1, B2, G1 and G2 in one chromatographic run with the very low LOD of 0.05 ng/mL for B1/G1 and 0.15 ng/mL for B2/G2.

## MATERIALS AND METHODS

**Tab. 1** Instrument setup

Column temperature	60°C	Time constant	0.2 s
Injection volume	10 µL	Excitation	365 nm
Injection mode	Full Loop	Emission	460 nm
Detection	FLD	Post column derivatization	254 nm
Data rate	50 Hz	Flow rate	2.4 mL/min



**Tab. 2** Pump program

Time (min)	Water (%)	ACN (%)	MeOH (%)
0.0	83	5	12
0.5	83	5	12
9.0	54	34	12
9.1	0	100	0
12.0	0	100	0
12.1	83	5	12
15.0	83	5	12

**Tab. 3** System configuration

Instrument	Description	Article No.
Pump	AZURA P6.1L, LPG	<a href="#">APH34EA</a>
Autosampler	AZURA AS 6.1L	<a href="#">AAA00AA</a>
Fluorescence Detector	RF-20A	<a href="#">A59200</a>
Thermostat	AZURA CT 2.1	<a href="#">A05852</a>
Column	Eurospher II 100-3 C18, 150 x 4.6 mm ID	<a href="#">15EE181E2G</a>
Post column derivatization	UVE Box, 50 Hz	<a href="#">A07547</a>
Interface box	IFU 2.1 Lan	<a href="#">AZB00XA</a>
Software	ClarityChrom 8.1	<a href="#">A1670</a>

## REFERENCES

- [16] Hedayati, M. T., Pasqualotto, A. C., Bowyer P., Denning, D. W. *Aspergillus flavus*: human pathogen, allergen and mycotoxin producer. *Microbiology* 153 (6), 1677-1692 (2007).
- [17] Bui-Klimke, T. R., Guclu, H., Kensler, T. W., Yuan, J.-M., Wu, F. Aflatoxin regulations and global pistachio trade: insights from social network analysis. *PLoS One* 9 (3), e92149 (2014).
- [18] World Health Organization (WHO) Aflatoxins. Food safety digest, Department of food safety and zoonoses. Ref. No.: WHO/NHM/FOS/RAM/18.1 (2018).
- [19] U.S. Department of Health and Human Services, Food and Drug Administration (FDA) Action levels for aflatoxins in animal food. CPG Sec. 683.100 (2019).
- [20] The European Commission, Commission Regulation (EC) No 401/2006 of 23 February 2006 laying down the methods of sampling and analysis for the official control of the levels of mycotoxins in foodstuffs (2016).
- [21] The European Commission, Commission Regulation (EC) No 1881/2006 of 19 December 2006 setting maximum levels for certain contaminants in foodstuffs (2006).
- [22] Folmert, K., Margraf, M., Monks, K. Quick and easy determination of aflatoxins in food matrices with photochemical post-column derivatization. *KNAUER, AppNote VFD0178*, 1-4 (2019).

## RELATED KNAUER APPLICATIONS

[VFD0152](#) - Determination of Aflatoxin M1 in milk

[VFD0175](#) - Verification of the mycotoxin patulin from apple juice with isocratic HPLC

# Determination of aflatoxins in dried fruit samples - from extraction to high efficient detection



Kristin Foltmert, Kate Monks; applications@knauer.net

KNAUER Wissenschaftliche Geräte GmbH, Hegauer Weg 38, 14163 Berlin; www.knauer.net  
In Kooperation mit Macherey Nagel, LCTech GmbH

## SUMMARY

Cultivation, drying and storage of dried fruits may contribute to the spread of molds, which produce mycotoxins – toxic secondary metabolites. Their consumption can lead to serious health damage. To ensure consumer safety it is inevitable to provide a simple, robust and exact method for the analysis of mycotoxins in food, especially the most often occurring aflatoxins. In this application note the sample extraction for dried fruits as preparation for a highly sensitive HPLC method is described.

## INTRODUCTION

Aflatoxins are the best known group of mycotoxins produced as secondary metabolites by fungi, mainly by *Aspergillus flavus* and *Aspergillus parasiticus*, but to a smaller extent also by other strains<sup>1</sup>. Aflatoxins can be produced on fruits and fruit products in the field or during storage, especially under warm conditions and high humidity. Thus, the infection with *Aspergillus* species most often occurs during the dehydration process of dried fruits. Offering natural flavors, high fiber, vitamins, minerals and phytonutrients, dried fruits are a vital economic and dietary staple for many civilizations. The juicy, sugar rich fruit pulp is an ideal culture medium for mold like *Aspergillus flavus/parasiticus*. Aflatoxins are stable compounds that are not destroyed during food processing like preserving or cooking. Although many aflatoxins exist, only a limited number is important in analytical practice. Aflatoxin B1 is most widespread and can be found in food and feed products such as peanuts, pistachios, corn and cottonseed, dried fruits and all processed

products. It is highly toxic and the WHO classified it as a group 1 carcinogen<sup>2</sup>. The aflatoxins B2, G1 and G2 are usually found accompanying B1, in lower concentrations in the contaminated samples (Fig. 1). Governmental institutions and health protection agencies like FDA, WHO and European Commission apply these methods on a large scale to control marketed food products and animal feed<sup>2,3,4</sup>. Additionally, the presence of aflatoxins B1, B2, G1 and G2 in a variety of processed and unprocessed foods is controlled in countries around the world. The EU regulates aflatoxin B1 at 2 parts per billion (ppb) and total aflatoxins (B1, B2, G1 and G2) at 4 ppb in ready-to-eat dried fruits and 10 ppb for those intended for further processing<sup>5</sup>. The lowest maximum aflatoxin level of 0.1 µg/kg for processed cereal-based foods and all kinds of dietary foods for special medical purpose, both for babies, infants and young children are set by the European Commission according to regulation EG 1881/2006<sup>5</sup>. The required verification method is



Additional Information

# Determination of aflatoxins in dried fruit samples - from extraction to high efficient detection

## INTRODUCTION

HPLC with fluorescence detection and preliminary sample extraction. Unfortunately, aflatoxins B1 and G1 show only minimal fluorescence and are thus difficult to detect. Irradiating the aflatoxins mixture with UV light of 254 nm, the aflatoxins B1 and G1 undergo photo-induced hydroxylation and can then be measured through fluorescence spectrometry more sensitively. The dedicated AZURA® Aflatoxin system consists of a fluorescence detector with coupled photochemical post column derivatization module. The photochemical post column derivatization enables a non-toxic and fast derivatization at room temperature. In comparison to previous methods, using saturated

iodine reaction coils or with electrochemical generated bromine in a KOBRA cell, no toxic halogenic reagents were used for derivatization. Thus, no halogenic solvent waste was produced. The complete analytical method, including recovery, standard deviation and robustness evaluation, is described in AppNote [VFD0178](#)<sup>6</sup>. Due to the manifold ingredients of dried fruits they are ranked as most difficult matrix for the aflatoxin analysis. The sample preparation for the analytical method described in this AppNote is suitable to reduce all intensive matrix effects to enable a highly reproducible and sensitive quantification of the aflatoxins.

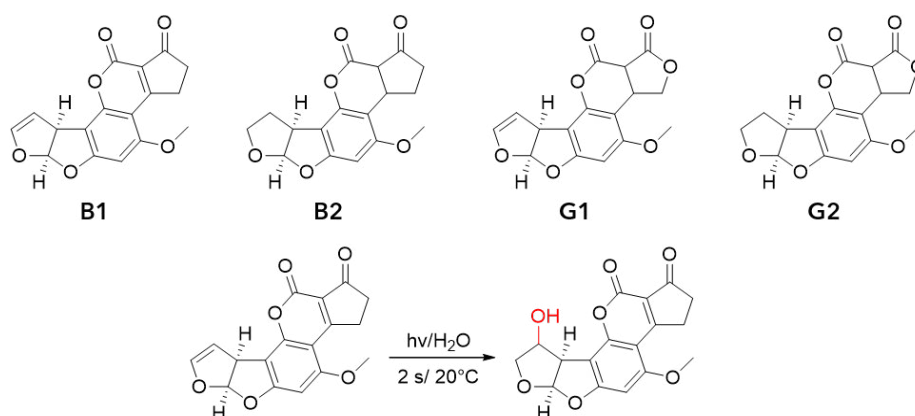


Fig. 1 Chemical structures of the four aflatoxins and the reaction mechanism of the photochemical activation.



## RESULTS

The sample preparation for the analytical aflatoxin study is based on three different extraction steps. During the first solid-liquid extraction aflatoxins can be extracted together with many other soluble compounds, removing most of the solid fruit material. The extracts contain a high concentration of matrix with fluorescence intensity up to 5000 counts (Fig. 2A). During the liquid-liquid extraction most fatty and hydrophobic compounds could be removed leaving fluorescence matrix peaks up to 200 counts (Fig. 2B). Most of the resulting matrix peaks, especially in the critical time between 6 and 9 minutes where the aflatoxins can be detected, could be removed during

SPE extraction (Fig. 2C). The two resulting peaks with higher fluorescence intensity up to 25 counts correspond to the solvents chloroform and acetone. With almost all matrix peaks removed, a highly sensitive and robust aflatoxin analysis can be assured. In Fig. 3 a various mixture of different food sample extractions spiked with 20 ng/mL of the aflatoxins B1/G1 and 6 ng/mL B2/G2 was analyzed (blue). The determined limits of detection (LOD) were 0.05 ng/mL for aflatoxins B1/G1 and 0.015 ng/mL for B2/G2 (Fig. 3, red). These values are 3.4 and 11.3 times lower than requested from the European Commission<sup>5</sup>.

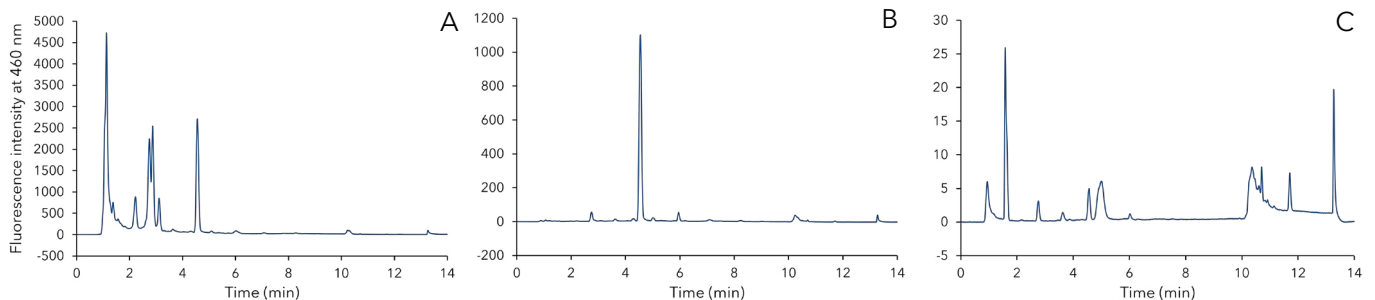


Fig. 2 Three different samples during extraction process. After the extraction with MeOH/H<sub>2</sub>O (A), before SPE (B) and after the SPE extraction (C).

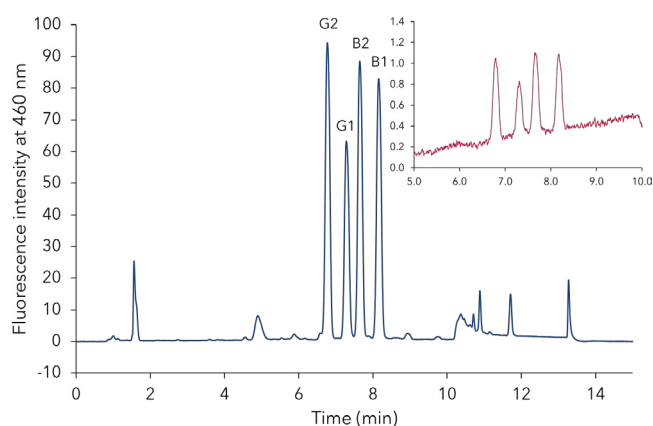


Fig. 3 Chromatogram of a mixture including equal parts of extraction products from peanuts, pistachios, cereal puree for babies and dried fruits (cherries, cranberries, raisins, aronia and plums) spiked with 20 ng/mL of the aflatoxins B1/G1 and 6 ng/mL B2/G2 (blue). Zoom into a chromatogram of a standard mixture of the four aflatoxins at the LOQ (red).

# Determination of aflatoxins in dried fruit samples - from extraction to high efficient detection

## SAMPLE PREPARATIONS

For sample preparation 50 g of commercially available mixture of dried fruits containing equal parts of cherries, cranberries, raisins, aronia and plums were grinded to a fine powder before suspending them with 20 mL MeOH:H<sub>2</sub>O (17:3, v/v) for 30 minutes. The suspension was filtered and 40 mL of the extract were filled into an extraction funnel. The extract was degreased two times with 25 mL *n*-hexane and the aqueous phase was extracted two times with 25 mL chloroform. The organic extract was evaporated to 3 mL before SPE extraction. The SPE cartridges were provided by Macherey Nagel and filled with 3 mL SiOH with a specific loading capacity of 500 mg. The SPE cartridge was conditioned with 3 mL *n*-hexane followed by 3 mL

chloroform before the extract was added. The bounded compounds from the extract, including the aflatoxins, were washed with *n*-hexane, diethyl ether and chloroform, 3 mL each. After washing, the collecting template was changed and the bounded compounds were removed by rinsing the SPE cartridge with 6 mL chloroform:acetone (9:1, v/v). The final extract was stored in a gas tight glass flask. The sample preparation was performed in three identical replicates to evaluate the reproducibility of the method. During sample preparation an analytical sample was collected after the extraction with MeOH/H<sub>2</sub>O, before and after the SPE extraction to verify the success of the extraction step.

## CONCLUSION

The described sample preparation for the extraction of aflatoxins from dried fruit can be used for all kind of food and animal feed which could be affected by aflatoxins. Analytical control samples after every extraction step could verify that the sample preparation is very efficient for the reduction of matrix peaks. Additionally, using the UVE photochemical reactor for post column derivatization in combination with the AZURA Analytical HPLC system and Eurospher II C18 column, it was possible to detect the four aflatoxins B1, B2, G1 and G2 in one chromatographic run of a spiked sample with the very low LOD of 0.05 ng/mL for B1/G1 and 0.015 ng/mL for B2/G2.

## MATERIALS AND METHODS

**Tab. 1** Instrument setup

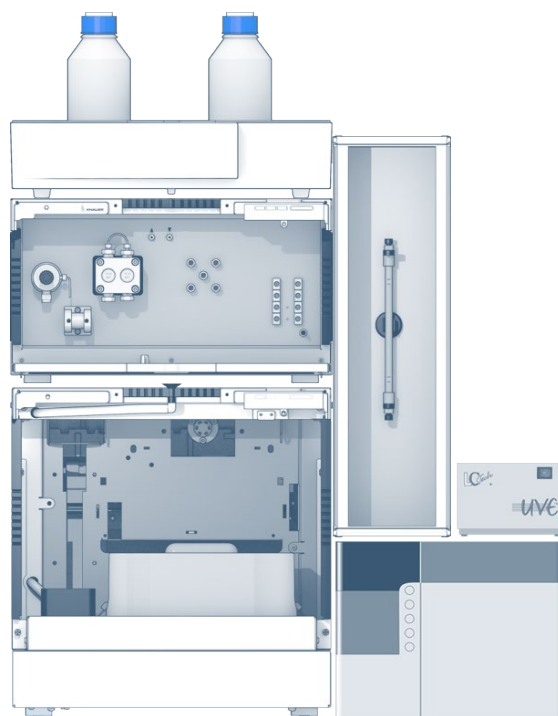
Column temperature	60°C	Time constant	0.2 s
Injection volume	10 µL	Excitation	365 nm
Injection mode	Full Loop	Emission	460 nm
Detection	FLD	Post column derivatization	254 nm
Data rate	50 Hz	Flow rate	2.4 mL/min

**Tab. 2** Pump program

Time (min)	Water (%)	ACN (%)	MeOH (%)
0.0	83	5	12
0.5	83	5	12
9.0	54	34	12
9.1	0	100	0
12.0	0	100	0
12.1	83	5	12
15.0	83	5	12

**Tab. 3** System configuration

Instrument	Description	Article No.
Pump	AZURA P6.1L, LPG	<a href="#">APH34EA</a>
Autosampler	AZURA AS 6.1L	<a href="#">AAA00AA</a>
Fluorescence detector	RF-20A	<a href="#">A59200</a>
Thermostat	AZURA CT 2.1	<a href="#">A05852</a>
Column	Eurospher II 100-3 C18, 150 x 4.6 mm ID	<a href="#">15EE181E2G</a>
Post column derivatization	UVE Box, 50 Hz	<a href="#">A07547</a>
Interface box	IFU 2.1 Lan	<a href="#">AZB00XA</a>
Software	ClarityChrom 8.1	<a href="#">A1670</a>



## REFERENCES

- [23] Hedayati, M. T., Pasqualotto, A. C., Bowyer P., Denning, D. W. *Aspergillus flavus*: human pathogen, allergen and mycotoxin producer. *Microbiology* 153 (6), 1677-1692 (2007).
- [24] World Health Organization (WHO) Aflatoxins. Food safety digest, Department of food safety and zoonoses. Ref. No.: WHO/NHM/FOS/RAM/18.1 (2018).
- [25] U.S. Department of Health and Human Services, Food and Drug Administration (FDA) Action levels for aflatoxins in animal food. CPG Sec. 683.100 (2019).
- [26] The European Commission, Commission Regulation (EC) No 401/2006 of 23 February 2006 laying down the methods of sampling and analysis for the official control of the levels of mycotoxins in foodstuffs (2016).
- [27] The European Commission, Commission Regulation (EC) No 1881/2006 of 19 December 2006 setting maximum levels for certain contaminants in foodstuffs (2006).
- [28] Folmert, K., Margraf, M., Monks, K. Quick and easy determination of aflatoxins in food matrices with photochemical post-column derivatization. KNAUER, AppNote VFD0178, 1-4 (2019).

## RELATED KNAUER APPLICATIONS

[VFD0152](#) - Determination of Aflatoxin M1 in milk

[VFD0175](#) - Verification of the mycotoxin patulin from apple juice with isocratic HPLC

[VFD0178](#) - Quick and easy determination of aflatoxins in food matrices with photochemical post column derivatization

[VFD0179](#) - Determination of aflatoxins in peanut samples - from extraction to high efficient detection

[VFD0180](#) - Determination of aflatoxins in pistachio samples - from extraction to high efficient detection

[VFD0182](#) - Determination of aflatoxins in cereal baby food samples - from extraction to high efficient detection

# Determination of aflatoxins in cereal baby food samples - from extraction to high efficient detection



Kristin Folmert, Kate Monks; applications@knauer.net

KNAUER Wissenschaftliche Geräte GmbH, Hegauer Weg 38, 14163 Berlin; www.knauer.net

In Kooperation mit Macherey Nagel, LCTech GmbH

## SUMMARY

Cultivation, drying and storage of cereals may contribute to the spread of molds, which produce mycotoxins – toxic secondary metabolites. Their consumption can lead to serious health damage. So it is inevitable to provide a simple, robust and exact method for the analysis of mycotoxins in food, especially the most often occurring aflatoxins to ensure consumer safety. In this application note the sample extraction for processed cereals in baby food products as preparation for a highly sensitive HPLC method is described.

## INTRODUCTION

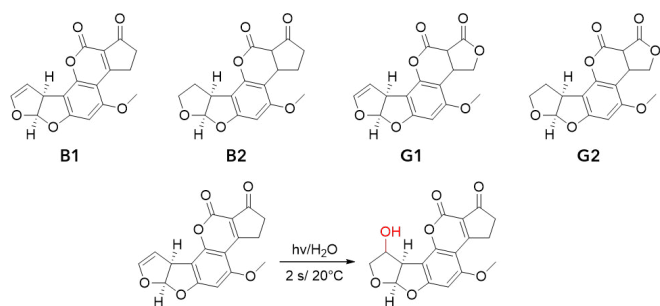
Aflatoxins are the best known group of mycotoxins produced as secondary metabolites by fungi, mainly by *Aspergillus flavus* and *Aspergillus parasiticus*, but to a smaller extent also by other strains<sup>1</sup>. Aflatoxins can be produced on cereals in the field or during storage, especially under warm conditions and high humidity. Aflatoxins are stable compounds that are not destroyed during food processing like cooking or baking. That is why they also can be present in derived products such as processed cereal-based foods and baby foods for infants and young children. During the first several months of life, at the age of 4 to 6 months, infants require the gradual replacement of breast milk with infant cereal products, which are frequently the first solid meal used in infant feeding. Infants are more susceptible to aflatoxins and other mycotoxins. Due to their rapid growth rate, liver

damage and other toxic influences are more critical than for adults. In addition, infants have increased vulnerability to contaminants than adults due to their lower body weight, reduced ability to detoxify hazardous agents and a more restricted diet<sup>2</sup>. Most baby foods for infants and young children are multi-cereal, as many different grains are used as ingredients, so increasing the probability of aflatoxin contamination. Although many aflatoxins exist, only a limited number is important in analytical practice. Aflatoxin B1 is most widespread and can be found in food and feed products such as peanuts, pistachios, corn and cottonseed, dried fruits and all processed products. It is highly toxic and the WHO classified it as a group 1 carcinogen<sup>3</sup>. The aflatoxins B2, G1 and G2 are usually found accompanying B1, in lower concentrations in the contaminated samples (Fig. 1).



# Determination of aflatoxins in cereal baby food samples - from extraction to high efficient detection

## INTRODUCTION



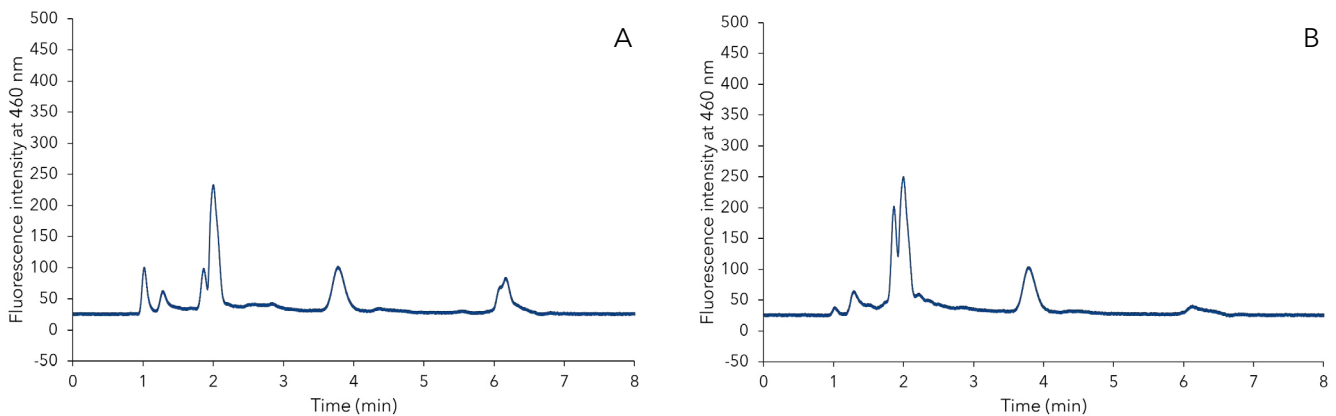
**Fig. 1** Chemical structures of the four aflatoxins and the reaction mechanism of the photochemical activation.

Governmental institutions and health protection agencies like FDA, WHO and European Commission apply these methods on a large scale to control marketed food products and animal feed<sup>3,4,5</sup>. Additionally, the presence of aflatoxins B1, B2, G1 and G2 in a variety of processed and unprocessed foods is controlled in countries around the world. The lowest maximum aflatoxin level of 0.1  $\mu\text{g}/\text{kg}$  for processed cereal-based foods and all kinds of dietary foods for special medical purpose, both for babies, infants and young children are set by the European Commission according to regulation EG 1881/2006<sup>6</sup>. From 2013 to 2018 the Rapid Alert System for Food and Feed of the European Commission (RASFF) registered 44 notifications for aflatoxins in cereals and bakery products and two in

baby food<sup>7</sup>. The alerts affecting baby foods were notified by Switzerland (aflatoxin B1 at 0.18  $\mu\text{g}/\text{kg}$ ) and the Netherlands (aflatoxin B1 from 0.21 to 0.39  $\mu\text{g}/\text{kg}$ )<sup>2</sup>. The required verification method is HPLC with fluorescence detection and preliminary sample extraction. Unfortunately, aflatoxins B1 and G1 show only minimal fluorescence and are thus difficult to detect. Irradiating the aflatoxins mixture with UV light of 254 nm, the aflatoxins B1 and G1 undergo photo-induced hydroxylation and can then be measured through fluorescence spectrometry more sensitively. The dedicated AZURA<sup>®</sup> Aflatoxin system consists of a fluorescence detector with coupled photochemical post column derivatization module. The photochemical post column derivatization enables a non-toxic and fast derivatization at room temperature. In comparison to previous methods, using saturated iodine reactions coils or with electrochemical generated bromine in a KOBRA cell, no toxic halogenic reagents were used for derivatization. Thus, no halogenic solvent waste was produced. The complete analytical method, including recovery, standard deviation and robustness evaluation, is described in AppNote [VFD0178](#)<sup>8</sup>. The sample preparation for the analytical method described in this AppNote is suitable to reduce intensive matrix effects to enable a highly reproducible and sensitive quantification of the aflatoxins.

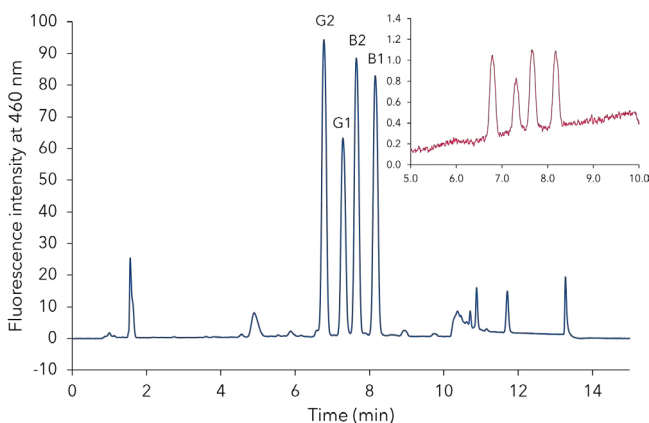
## RESULTS

The sample preparation for the analytical aflatoxin analysis is based on three different extraction steps. During the first solid-liquid extraction aflatoxins can be extracted together with many other soluble compounds, removing most of the solid material. During the liquid-liquid extraction most fatty and hydrophobic compounds could be removed. Most of the resulting matrix peaks, especially in the critical time between 6.5 and 8 minutes, where the aflatoxins can be detected, could be removed during SPE extraction (Fig. 2). Two of the resulting peaks with higher fluorescence intensity up to 250 counts correspond to the solvents chloroform ( $t_R = 2.0$  min) and acetone ( $t_R = 3.8$  min). With almost all matrix peaks removed, a highly sensitive and robust aflatoxin analysis can be assured.



**Fig. 2** Two different chromatograms of cereal containing baby food extraction samples without aflatoxins. The extract of baby puree on the left (A) and the extract of baby rusk on the right site (B).

In Fig. 3 a various mixture of different food sample extractions spiked with 20 ng/mL of the aflatoxins B1/G1 and 6 ng/mL B2/G2 was analyzed (blue). The determined limits of detection (LOD) were 0.05 ng/mL for aflatoxins B1/G1 and 0.015 ng/mL for B2/G2 (Fig. 3, red). These values are 3.4 and 11.3 times lower than requested from the European Commission<sup>6</sup>.



**Fig. 3** Chromatogram of a mixture including equal parts of extraction products from peanuts, pistachios, cereal puree for babies and dried fruits (cherries, cranberries, raisins, aronia and plums) spiked with 20 ng/mL of the aflatoxins B1/G1 and 6 ng/mL B2/G2 (blue). Zoom into a chromatogram of a standard mixture of the four aflatoxins at the LOQ (red).

# Determination of aflatoxins in cereal baby food samples - from extraction to high efficient detection

## SAMPLE PREPARATIONS

For sample preparation 50 g of commercially available baby rusk were grinded to a fine powder before suspending it with 20 mL MeOH:H<sub>2</sub>O (17:3, v/v) for 30 minutes. Cereal baby puree was directly suspended with 20 mL MeOH:H<sub>2</sub>O (17:3, v/v). The suspension was filtered and 40 mL of the extract were filled into an extraction funnel. The extract was degreased two times with 25 mL *n*-hexane and the aqueous phase was extracted two times with 25 mL chloroform. The organic extract was evaporated to 3 mL before SPE extraction. The SPE cartridges were provided by Macherey Nagel and filled with 3 mL SiOH with a specific loading capacity of 500 mg. The SPE cartridge was conditioned with 3 mL *n*-hexane followed by 3 mL

chloroform before the extract was added. The bounded compounds from the extract, including the aflatoxins, were washed with *n*-hexane, diethyl ether and chloroform, 3 mL each. After washing, the collecting template was changed and the bounded compounds were removed by rinsing the SPE cartridge with 6 mL chloroform:acetone (9:1, v/v). The final extract was stored in a gas tight glass flask. The sample preparation was performed in three identical replicates to evaluate the reproducibility of the method. During sample preparation an analytical sample was collected after the extraction with MeOH/H<sub>2</sub>O, before and after the SPE extraction to verify the success of the extraction step.

## CONCLUSION

The described sample preparation for the extraction of aflatoxins from cereal based baby food products can be used for all kind of food and animal feed which could be affected by aflatoxins. Analytical control samples after every extraction step could verify that the sample preparation is very efficient for the reduction of matrix peaks. Additionally, using the UVE photochemical reactor for post column derivatization in combination with the AZURA Analytical HPLC system and Eurospher II C18 column, it was possible to detect the four aflatoxins B1, B2, G1 and G2 in one chromatographic run of a spiked sample with the very low LOD of 0.05 ng/mL for B1/G1 and 0.015 ng/mL for B2/G2.



## MATERIALS AND METHODS

**Tab. 1** Instrument setup

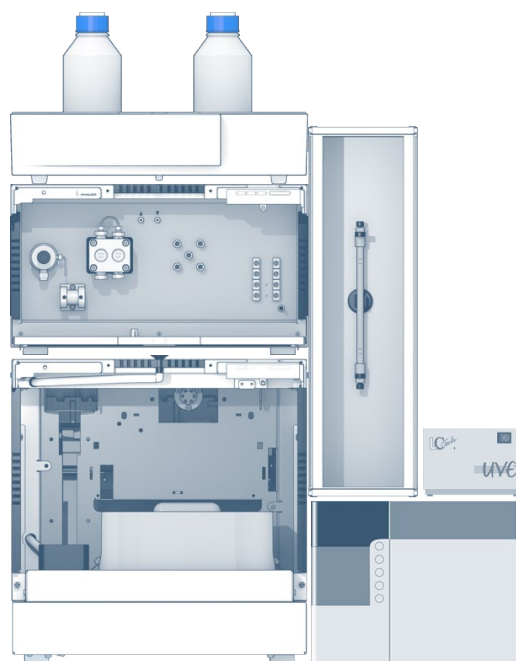
Column temperature	60 °C	Time constant	0.2 s
Injection volume	10 µL	Excitation	365 nm
Injection mode	Full Loop	Emission	460 nm
Detection	FLD	Post column derivatization	254 nm
Data rate	50 Hz	Flow rate	2.4 mL/min

**Tab. 2** Pump program

Time (min)	Water (%)	ACN (%)	MeOH (%)
0.0	83	5	12
0.5	83	5	12
9.0	54	34	12
9.1	0	100	0
12.0	0	100	0
12.1	83	5	12
15.0	83	5	12

**Tab. 3** System configuration

Instrument	Description	Article No.
Pump	AZURA P6.1L, LPG	<a href="#">APH34EA</a>
Autosampler	AZURA AS 6.1L	<a href="#">AAA00AA</a>
Fluorescence detector	RF-20A	<a href="#">A59200</a>
Thermostat	AZURA CT 2.1	<a href="#">A05852</a>
Column	Eurospher II 100-3 C18, 150 x 4.6 mm ID	<a href="#">15EE181E2G</a>
Post column derivatization	UVE Box, 50 Hz	<a href="#">A07547</a>
Interface box	IFU 2.1 Lan	<a href="#">AZB00XA</a>
Software	ClarityChrom 8.1	<a href="#">A1670</a>



## REFERENCES

- [29] Hedayati, M. T., Pasqualotto, A. C., Bowyer P., Denning, D. W. *Aspergillus flavus*: human pathogen, allergen and mycotoxin producer. *Microbiology* 153 (6), 1677-1692 (2007).
- [30] Herrera, M., Bervis, N., Carramiñana, J. J., Juan, T., Herrera, A., Ariño, A., Lorán, S. Occurrence and exposure assessment of aflatoxins and deoxynivalenol in cereal-based baby foods for infants. *Toxins* 11 (3) 150 (2019).
- [31] World Health Organization (WHO) Aflatoxins. Food safety digest, Department of food safety and zoonoses. Ref. No.: WHO/NHM/FOS/RAM/18.1 (2018).
- [32] U.S. Department of Health and Human Services, Food and Drug Administration (FDA) Action levels for aflatoxins in animal food. CPG Sec. 683.100 (2019).
- [33] The European Commission, Commission Regulation (EC) No 401/2006 of 23 February 2006 laying down the methods of sampling and analysis for the official control of the levels of mycotoxins in foodstuffs (2016).
- [34] The European Commission, Commission Regulation (EC) No 1881/2006 of 19 December 2006 setting maximum levels for certain contaminants in foodstuffs (2006).
- [35] Rapid Alert System for Food and Feed (RASFF), accessed on 31 January 2019, <<https://webgate.ec.europa.eu/rasff-window/portal/>>.
- [36] Folmert, K., Margraf, M., Monks, K. Quick and easy determination of aflatoxins in food matrices with photochemical post-column derivatization. KNAUER, AppNote VFD0178, 1-4 (2019).

## RELATED KNAUER APPLICATIONS

[VFD0152](#) - Determination of Aflatoxin M1 in milk

[VFD0175](#) - Verification of the mycotoxin patulin from apple juice with isocratic HPLC

[VFD0178](#) - Quick and easy determination of aflatoxins in food matrices with photochemical post column derivatization

[VFD0179](#) - Determination of aflatoxines in peanut samples - from extraction to high efficient detection

[VFD0180](#) - Determination of aflatoxines in pistachio samples - from extraction to high efficient detection

[VFD0181](#) - Determination of aflatoxines in dried fruits - from extraction to high efficient detection

# Everything solved - Carbohydrate content in instant coffee with PAD



Juliane Böttcher, Mareike Margraf, Kate Monks; applications@knauer.net  
KNAUER Wissenschaftliche Geräte GmbH, Hegauer Weg 38, 14163 Berlin; www.knauer.net.

## SUMMARY

DIN ISO 11292:1995 regulates the determination and analysis of carbohydrates in instant coffee using anion exchange chromatography combined with pulsed amperometric detection (PAD). Here an adapted method is provided, using a polymer-based cation-exchange column in the  $\text{Pb}^{2+}$  ionic form and PAD.

## INTRODUCTION

Instant coffee is very popular in many areas of the world. It is made from dried coffee extract either using spray-drying or freeze-drying<sup>1</sup>. As carbohydrates are main ingredients of coffee beans, one quality measure for instant coffee is its free and total sugar content. This analysis is regulated by ISO 11292:1995<sup>2</sup> or AOAC method 995.13. The carbohydrates can act as aroma binders and foam stabilizers. They can also influence the viscosity of the drink and are a good tracer for assessing the authenticity<sup>3</sup>. The free content is determined just after dilution of the powder. While the total sugar content requires a

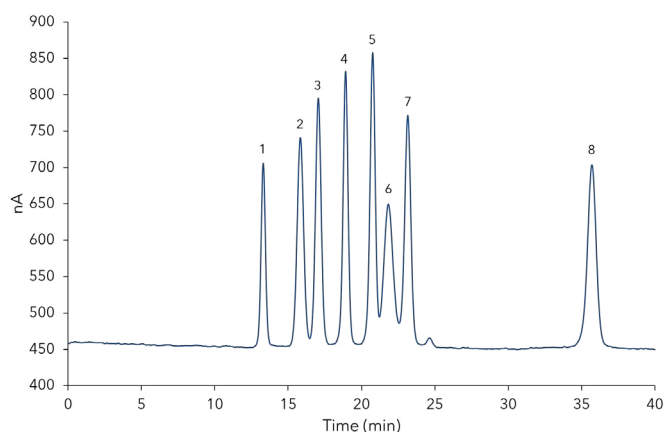
hydrolysis step prior to the determination. According to ISO 11292:1995 the contents of the following carbohydrates are of interest: arabinose, fructose, galactose, glucose, mannose, sucrose, mannitol and xylose. Furthermore, the determination of total glucose and total xylose content is an indicator to evaluate the authenticity of instant coffee products. The specification limit of an indicator carbohydrate is the maximum permitted concentration, above which a soluble coffee is considered as adulterated. The limit is defined as the sum of the maximum content and the expanded uncertainty<sup>4</sup>.



# Everything solved - Carbohydrate content in instant coffee with PAD

## RESULTS

A five-point calibration for the eight carbohydrates in a range from 0.35 µg/mL to 5.00 µg/mL was prepared. All calibration curves showed good linearity with a correlation coefficient of  $R^2 > 0.9999$ . **Fig. 1** exemplarily displays the chromatogram of a mixed standard at a concentration of  $\beta=5.00$  µg/mL.



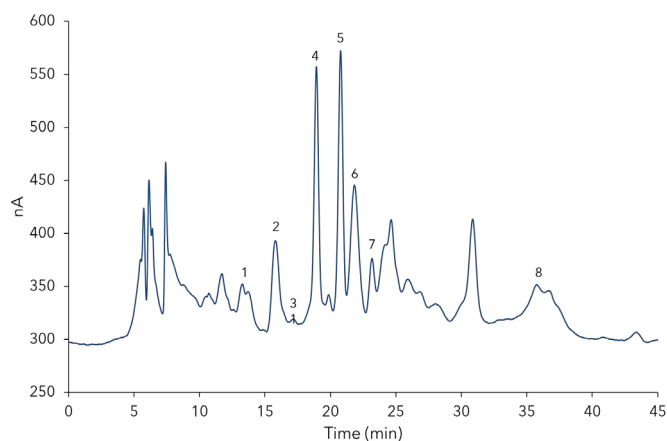
**Fig. 1** Chromatogram of mixed standard with  $\beta=5.00$  µg/mL. 1 - saccharose, 2 - glucose, 3 - xylose, 4 - galactose, 5 - arabinose, 6 - mannose, 7 - fructose, 8 - mannitol.

The dry matter of two instant coffee samples was determined according to DIN 10764 4:2007 03<sup>5</sup> by heating to 95 °C under atmospheric pressure. For both samples a mass loss of  $w=2.79$  g/100 g was calculated. Furthermore, the repeatability of the method was determined with multiple measurements ( $n=5$ ). The relative standard deviation for peak area and retention time was calculated. **Tab. 1** displays the results for repeatability.

**Tab. 1** Repeatability ( $n=5$ ) for peak area and retention time

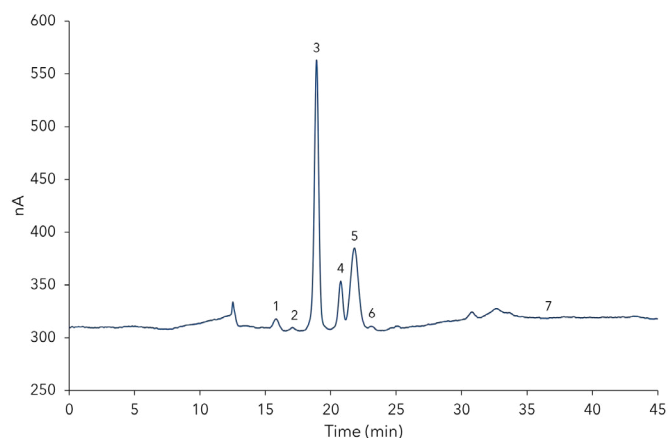
Peak	Compound	% RSD Retention time	% RSD Area
1	Saccharose	0.04	0.43
2	Glucose	0.04	1.19
3	Xylose	0.00	0.88
4	Galactose	0.02	0.59
5	Arabinose	0.00	0.81
6	Mannose	0.04	1.07
7	Fructose	0.03	1.76
8	Mannitol	0.01	0.97

The two different instant coffee samples were prepared following the described sample preparation for free and total hydrocarbon content. **Fig. 2** shows the measurement of free carbohydrate content for one of the samples.



**Fig. 2** Chromatogram of free hydrocarbon content. 1 - saccharose, 2 - glucose, 3 - xylose, 4 - galactose, 5 - arabinose, 6 - mannose, 7 - fructose, 8 - mannitol.

**Fig. 3** shows the determination of the total content of the same sample after hydrolysis.



**Fig. 3** Chromatogram of hydrolyzed coffee sample. 1 - glucose, 2 - xylose, 3 - galactose, 4 - arabinose, 5 - mannose, 6 - fructose, 7 - mannitol.

The following **Tab. 2** summarizes the measured amounts for the free and total hydrocarbon content in the instant

## RESULTS

coffee samples. The mass loss was considered for calculation. In order to avoid incorrect declarations that adulterated products are 100% pure soluble coffee, the ISO 24114:2011-04 regulates the criteria for the authenticity of instant coffee products<sup>4</sup>. Therefore, the total content of two indicator carbohydrates, xylose and glucose, is considered. The specification limit for total glucose

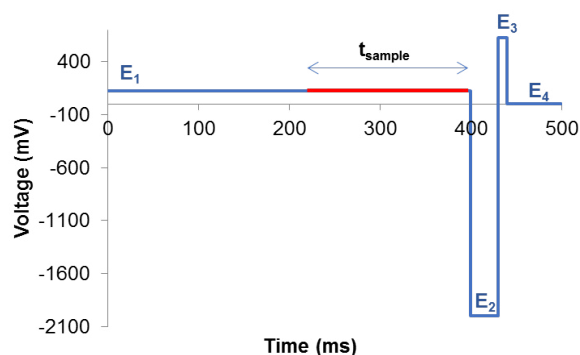
content is 2.46% and 0.45% for total xylose content. Both measured samples show similar amounts for the free and total carbohydrate content. The values for the two indicator carbohydrates are within the specification limit of ISO 24114:2011-04. So, the measured samples could be labelled as pure soluble coffee.

**Tab. 2** Free and total carbohydrate content in samples

Peak	Compound	Sample 1 free [g/100g]	Sample 1 total [g/100g]	Sample 2 free [g/100g]	Sample 2 total [g/100g]
1	Saccharose	0.26	-	0.09	-
2	Glucose	0.58	1.00	0.54	1.29
3	Xylose	0.01	0.18	0.01	0.23
4	Galactose	0.98	23.33	0.95	17.71
5	Arabinose	1.23	3.97	0.96	3.16
6	Mannose	0.57	13.52	0.96	16.47
7	Fructose	0.18	0.48	0.16	0.40
8	Mannitol	-	0.26	0.05	0.13
<b>Total</b>		<b>3.80</b>	<b>42.74</b>	<b>3.71</b>	<b>39.39</b>

## SAMPLE PREPARATIONS

When using a system that is not bioinert, it needs to be passivated with 20% nitric acid at a flow rate of 1mL/min for about 30 minutes. Afterwards flush with deionized water until the pH value is neutral. The 300 mM sodium hydroxide (NaOH) solution for post column addition was prepared in plastic flasks using a 50% (w/w) carbonate free NaOH stock solution. After dilution the NaOH eluent was transferred to a plastic bottle. The eluent was degassed using ultra sonication and additionally vacuum filtrated. To keep the eluent carbon dioxide free, a filter was installed on top of the bottle. All calibration standards were dissolved in deionized water. The ECD was operated in pulsed mode using a 4-step PAD potential waveform (Fig. 4).



**Fig. 4** 4-step PAD potential waveform for the detection of monosaccharides and other carbohydrates. The sample detection occurs during the highlighted time period  $t_{\text{sample}}$ .

# Everything solved - Carbohydrate content in instant coffee with PAD

## SAMPLE PREPARATIONS

**Free carbohydrate content:** Approximately 300 mg of instant coffee sample were weighed into a 100 mL volumetric flask and 70 mL deionized water were added. The flask was swirled until the sample was dissolved completely and filled up to the mark with water. 5 - 10 mL of this solution were filtered through a disposable C18 cartridge, the first millilitres were discarded. Here, Macherey Nagel Chromabond C18 cartridges (REF 730003) were used. The filtrate was then again filtered through a 0.2 µm syringe filter and diluted with water in a ratio of 1:10. 20 µL of the prepared sample were injected.

**Total carbohydrate content:** Approximately 300 mg of instant coffee sample are weighed into a 100 mL volumetric flask and 50 mL of 1.0 M hydrochloric acid were added. The flask was swirled slightly and afterwards

placed in a boiling water bath for 150 minutes. Every 30 minutes the solution was swirled by hand. After cooling the sample down to room temperature, the flask was filled up to mark with deionized water. The sample solution was filtered through a folded filter. 3 mL of this filtrate were filtered through a disposable cartridge in silver form and the first millilitre was discarded. Here, Macherey Nagel Chromafix PS-Ag<sup>+</sup> cartridges (REF 731865) were used. At last, the sample was filtered through a 0.2 µm syringe filter and diluted with water in a ratio of 1:10. 20 µL of the prepared sample were injected.

**Determination of dry matter:** The dry matter of the soluble coffee products was determined according to DIN 10764 4:2007 03<sup>5</sup> by heating under atmospheric pressure.

## CONCLUSION

The provided adapted method using a polymer-based cation-exchange column in the Pb<sup>2+</sup> ionic form and pulsed amperometric detection is suitable for the analysis of carbohydrates in instant coffee and to confirm authenticity of soluble coffee products. Using NaOH post column addition makes it possible to apply polymer columns and therewith, a very wide range of concentrations on the same, very long-lasting column can be analysed.

## MATERIALS AND METHODS

**Tab. 3** Method parameters

Column temperature	60 °C
Injection volume	20 µL
Injection mode	Partial loop
Detection	ECD

**Tab. 5** ECD settings (pulsed mode)

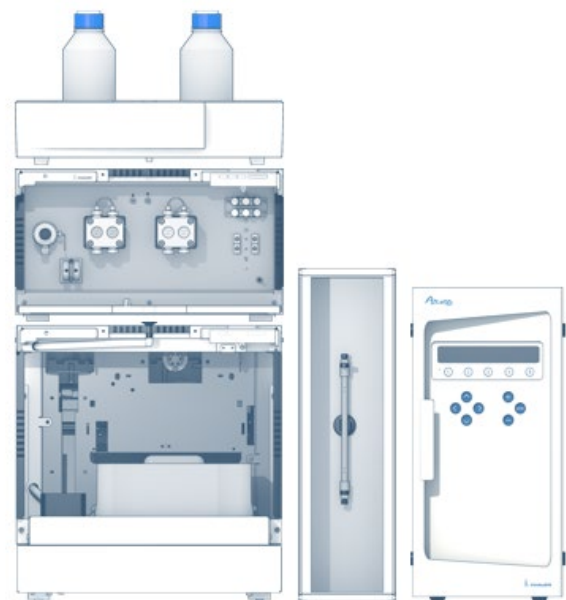
E1	0.10 V	t1	0.40 s
E2	-2.00 V	t2	0.02 s
E3	0.60 V	t3	0.01 s
E4	-0.10 V	t4	0.20 s
Cell temperature	40 °C	ts	200 ms
Range	1 µA		
Polarity	+		
Compensation	On		
AST	2		
Filter	0.02 Hz		

**Tab. 6** System configuration

Instrument	Description	Article No.
Pump	AZURA P6.1L, HPG	<a href="#">APH35EA</a>
Autosampler	AZURA AS6.1L	<a href="#">AAA00AA</a>
Detector	AZURA ECD 2.1	<a href="#">A1651</a>
Flow cell	SenCell - HyREF (Pd/H2) Reference electrode/ Au Working electrode	<a href="#">A1652-3</a>
Thermostat	AZURA CT 2.1	<a href="#">A05852</a>
Column	Agilent Metacarb 87P, 300 x 7.8 mm ID	
Software	ClarityChrom 8.1 - workstation, autosampler control included	<a href="#">A1670</a>
Software	ClarityChrom 8.1 - System Suitability Extension (SST)	<a href="#">A1677</a>

**Tab. 4** Pump parameters

Eluent	water
Gradient	isocratic
Flow rate	0.5 mL/min
Post column eluent	300 mM sodium hydroxide
Gradient	isocratic
Flow rate	0.8 mL/min
Run time	45 min



## REFERENCES

- [37] Bjarnadottir, A. Instant coffee: Good or bad? <https://www.healthline.com/nutrition/instant-coffee-good-or-bad#what-it-is> (December 11, 2019).
- [38] ISO 11292:1995(E) Instant coffee - Determination of free and total carbohydrate contents - Method using high-performance anion-exchange chromatography. <https://www.iso.org/obp/ui/#iso:std:iso:11292:ed-1:v2:en> (December 11, 2019).
- [39] Antec Scientific. Carbohydrate analysis in instant coffee according to adapted ISO method 11292:1995. [https://antecscientific.com/downloads/notes/food/220\\_006\\_01%20-%20Carbohydrate%20Analysis%20in%20Instant%20Coffee.pdf](https://antecscientific.com/downloads/notes/food/220_006_01%20-%20Carbohydrate%20Analysis%20in%20Instant%20Coffee.pdf) (December 11, 2019).
- [40] ISO 24114:2011-04 Instant coffee - Criteria for authenticity. <https://www.iso.org/obp/ui/#iso:std:iso:24114:ed-1:v1:en> (December 11, 2019).
- [41] DIN 10764-4:2007-03 Analysis of coffee and coffee products - Determination of loss in mass of soluble coffee - Part 4: Method for soluble coffee and soluble coffee products by heating under atmospheric pressure (routine method) (2007).

## RELATED KNAUER APPLICATIONS

[VFD0183](#) - Sensitivity boost - comparison of electrochemical and refractive index detection for sugar analysis

[VFD0186](#) - Increasing sensitivity of carbohydrate analysis by switching from refractive index to electrochemical detection



# Determination of biogenic amines with automated precolumn derivatization



Juliane Boettcher, Kate Monks; [applications@knauer.net](mailto:applications@knauer.net)

KNAUER Wissenschaftliche Geräte GmbH, Hegauer Weg 38, 14163 Berlin; [www.knauer.net](http://www.knauer.net)

## SUMMARY

Biogenic amines are found in certain foods and play a role as regulatory agents in the human metabolism<sup>1</sup>. In food and beverages they are formed by enzymes out of raw materials or are generated by microbiological decarboxylation of amino acids. Many of them possess a strong pharmacologic effect and some are important as precursors of hormones and components of coenzymes. The biogenic amine poisoning leads to toxicological risks and health hazards that trigger psychoactive, vasoactive, and hypertensive effects resulting from the consumption of high amounts of biogenic amines in foods<sup>2</sup>.

## INTRODUCTION

Biogenic amines are organic bases with low molecular weight. A distinction is made between aromatic amines such as histamine, tyramine, phenylethylamine and aliphatic amines like putrescine and cadaverine. They are important in a wide variety of ways. They are aroma and flavour agents; some are involved in non-enzymatic browning, whereas others are used as criteria in quality control of foodstuffs<sup>3</sup>. Furthermore, biogenic amines have critical biological roles in the body. They have essential physiological functions such as the regulation of growth and blood pressure or the control of the nerve conduction<sup>2</sup>. Histamine and

tyramine are vasoactive, which means they influence decreasing or increasing blood vessel diameters. In addition, in high concentrations these substances can affect blood pressure and cause headaches, allergy-like reactions and even severe food poisoning. Putrescine and cadaverine are often cited as enhancers of these effects<sup>3</sup>. The following application focusses on the determination of histamine, tyramine, putrescine and cadaverine using precolumn derivatization with ortho-phthalaldehyde (OPA). The derivatization process was automated using the AZURA AS 6.1L auto-sampler and its "mix method" feature.

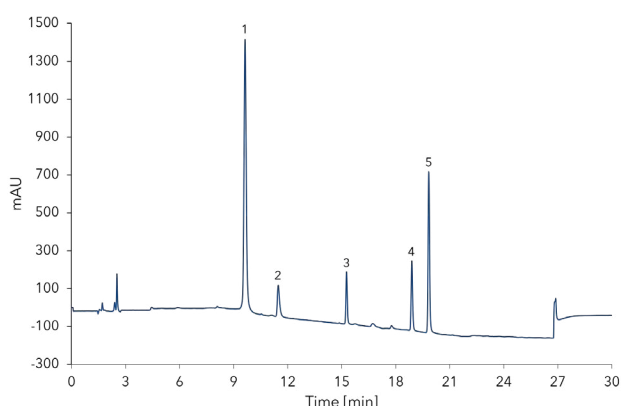


Additional Information

# Determination of biogenic amines with automated precolumn derivatization

## RESULTS

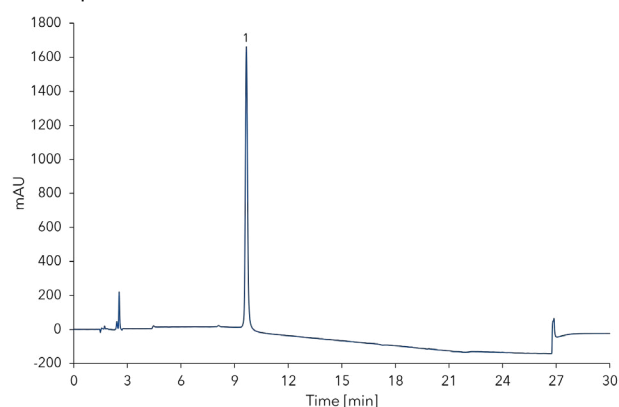
First the substances were measured as single standards for identification. Then a mixed standard of tyramine, histamine, putrescine and cadaverine was used. The precolumn derivatization of the standard was performed using the mixed method option of the configured autosampler but can as well be carried out manually. **Fig. 1** shows the analysis of the mixed amine standard at a concentration of 42 mg/kg for histamine, tyramine, putrescine and 64 mg/kg for cadaverine. A blank with water was measured to confirm, that the first detected peak is caused due to precolumn derivatization.



**Fig. 1** Mixed amine standard. 1 - derivatization peak, 2 - histamine, 3 - tyramine, 4 - putrescine, 5 - cadaverine.

**Fig. 2** shows the measurement of the derivatized blank. Based on the measurement at a concentration of 10 mg/kg for histamine, tyramine, putrescine and

16 mg/kg for cadaverine, the limit of detection (LOD) and limit of quantification (LOQ) of the method was calculated.



**Fig. 2** Chromatogram of derivatized blank (water). 1 - derivatization peak.

**Tab. 1** summarizes the calculated values for these parameters. For LOD a signal-to-noise ratio of  $S/N=3$  was taken as basis and  $S/N=10$  for LOQ. Furthermore, the reproducibility was checked by performing multiple measurements. **Tab. 2** summarizes the relative standard deviation (%RSD) for evaluation of the parameter retention time and peak area.

**Tab. 1** LOD and LOQ values for amines

	LOD [mg/kg]	LOQ [mg/kg]
histamine	0.28	0.93
tyramine	0.15	0.50
putrescine	0.13	0.44
cadaverine	0.10	0.33

**Tab. 2** Relative standard deviation for area and retention time (n=5)

Area [mAU.s]	Rep 1	Rep 2	Rep 3	Rep 4	Rep 5	Mean	RSD %
histamin	1485.502	1504.722	1487.193	1478.000	1476.772	1486.438	0.67
tyramin	1461.657	1463.140	1461.513	1453.767	1453.292	1458.674	0.29
putrescin	2115.141	2090.665	2132.075	2106.201	2095.404	2101.263	0.70
cadaverin	5150.474	5049.993	5038.044	5066.948	5085.094	5078.111	0.78

Retention time [min]	Rep 1	Rep 2	Rep 3	Rep 4	Rep 5	Mean	RSD %
histamin	11.487	11.491	11.484	11.483	11.487	11.486	0.02
tyramin	15.289	15.288	15.281	15.278	15.280	15.283	0.03
putrescin	18.917	18.914	18.907	18.903	18.907	18.910	0.03
cadaverin	19.858	19.855	19.848	19.845	19.848	19.851	0.02

## SAMPLE PREPARATIONS

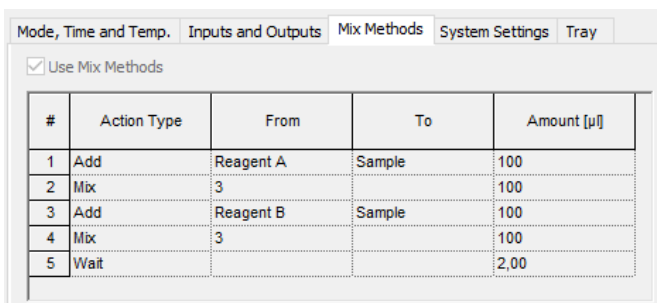
All standards were dissolved in deionized water. The precolumn derivatization was performed using the “mix methods” option of the AZURA AS 6.1L autosampler. It can also be carried out manually but to ensure repeatable results the use of the autosampler is recommended. For derivatization two solutions were prepared.

**Borate buffer:** 0.5 M sodium tetraborate solution adjusted to pH 9.2.

**OPA-reagent:** 100 mg OPA were weighed in an appropriate vessel. Then add 9 mL of methanol and 1 mL of the borate buffer. After the complete dissolution of OPA, 100  $\mu$ L mercaptoethanol were added.

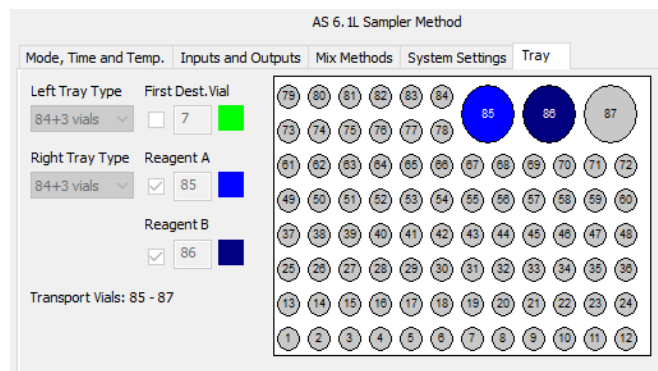
## DERIVATIZATION PROTOCOL

Provide 350  $\mu$ L of sample/standard in an autosampler vial. Add 100  $\mu$ L of borate buffer (A) and mix thoroughly. Add 100  $\mu$ L of the OPA reagent (B) and mix again. Wait for two minutes. Inject 1-10  $\mu$ L of the derivatized sample. **Fig. 3** and **Fig. 4** show screenshots of the autosampler mix methods setup. In advance a position of the reagents A and B must be chosen (**Fig. 4**).



#	Action Type	From	To	Amount [ $\mu$ L]
1	Add	Reagent A	Sample	100
2	Mix	3		100
3	Add	Reagent B	Sample	100
4	Mix	3		100
5	Wait			2,00

**Fig. 3** Mix method setup for automated precolumn derivatization.



**Fig. 4** Exemplarily tray positions for reagents A and B using the 84+3 autosampler tray.

## CONCLUSION

The developed method is very robust, including the automated derivatization procedure. As seen in **Tab. 2**, the achieved results for area are below 1% RSD. Also, the values for retention time are reproducible and do not exceed 0.05% relative standard deviation. All peaks are baseline separated and show a resolution  $> 6$ , which is an advantage concerning disturbing matrix effects. Referring to “Commission Regulation (EU) No 1019/2013 of 23 October 2013 amending Annex I to Regulation (EC) No 2073/2005 as regards histamine in fishery products”<sup>4</sup> the maximum residue level (MRL) for histamine is set to 400 mg/kg. The calculated values for LOD and LOQ (0.28 mg/kg and 0.93 mg/kg) are far below MRL, which makes the applied method also suitable for food and quality control.

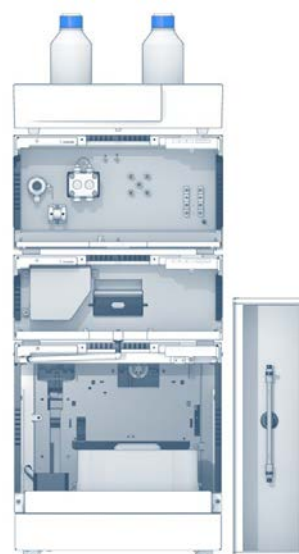
## MATERIALS AND METHODS

**Tab. 3** Instrument setup

Column temperature	25 °C		
Injection volume	5 µL		
Injection mode	Partial Loop		
Detection	UV 230 nm		
Data rate	20 Hz		
Time constant	0.05 s		
Eluent (A)	100 mM sodium acetate pH 5.8 (adjusted with acetic acid)		
Eluent (B)	Acetonitrile		
Flow rate	1 mL/min		
Gradient	Time [min]	% A	% B
	0.00	70	30
	5.00	70	30
	20.00	20	80
	25.00	20	80
	30.00	70	30

**Tab. 4** System configuration

Instrument	Description	Article No.
Pump 1	AZURA P6.1L, LPG	<a href="#">APH34EA</a>
Autosampler	AZURA AS 6.1L	<a href="#">AAA00AA</a>
Detector	AZURA DAD 2.1L	<a href="#">ADC01</a>
Flow Cell	Analytical KNAUER Pressure Proof UV Flow Cell Cartridge	<a href="#">AMC38</a>
Thermostat	AZURA CT 2.1	<a href="#">A05852</a>
Column	Eurospher 100-5 C18, 250 x 4.0 mm ID	<a href="#">25DE181ESJ</a>
Software	ClarityChrom 8.1 - Workstation, autosampler control included	<a href="#">A1670</a>
Software	ClarityChrom 8.1 - PDA extension	<a href="#">A1676</a>



## REFERENCES

- [42] ScienceDirect, Biogenic amine. <https://www.sciencedirect.com/topics/neuroscience/biogenic-amine> (January 30, 2020)
- [43] Erdag, D., Merhan, O., Yildiz, B. Biochemical and pharmacological properties of biogenic amines. In: Proestos, C. Biogenic amines. IntechOpen (2018).
- [44] Austrian Agency for Health and Food Safety Ltd. (AGES), Biogenic amines. <https://www.ages.at/en/topics/residues-and-contaminants/biogenic-amines/> (January 30, 2020).
- [45] Commission Regulation (EU) No 1019/2013 of 23 October 2013 amending Annex I to Regulation (EC) No 2073/2005 as regards histamine in fishery products Text with EEA relevance. <https://eur-lex.europa.eu/eli/reg/2013/1019/oj/eng> (January 30, 2020).

## RELATED KNAUER APPLICATIONS

[VFD0026J](#) - Determination of Amines in wine with precolumn derivatization (OPA)

[VBS0029N](#) - Determination of Amino acids by UHPLC with automated OPA-Derivatization by the Autosampler

# Increasing sensitivity of carbohydrate analysis by switching from refractive index to electrochemical detection



Juliane Boettcher, Mareike Margraf, Kate Monks; applications@knauer.net  
KNAUER Wissenschaftliche Geräte GmbH, Hegauer Weg 38, 14163 Berlin; www.knauer.net

## SUMMARY

Nowadays sugar substitutes are used in many products, not only for diabetic purposes but to make products more attractive for customers. Furthermore, people are interested in a healthier lifestyle which includes consuming less sugar. Therefore, quality control of sugar and sugar substitutes in food and beverages is compulsory to assure the correct labelling of products and composition of ingredients. Using KNAUER Eurokat columns in combination with an electrochemical detector expands the application area of carbohydrate analysis.

## INTRODUCTION

Sweet taste is favoured by human beings. People instinctively desire the pleasure of sweetness, which resulted in a preference for sweet foods and beverages<sup>1</sup>. Since sugar is rich in calories, a lot of people are switching to light products containing sugar substitutes. These products contain less calories and are often obtained from natural crude materials, e.g. wood fibres of the birch. This application focuses on the determination of commonly used sugars and natural sugar substitutes. Sucralose (E 955) is a high-intensity sweetener, about 600 times higher than saccharose.

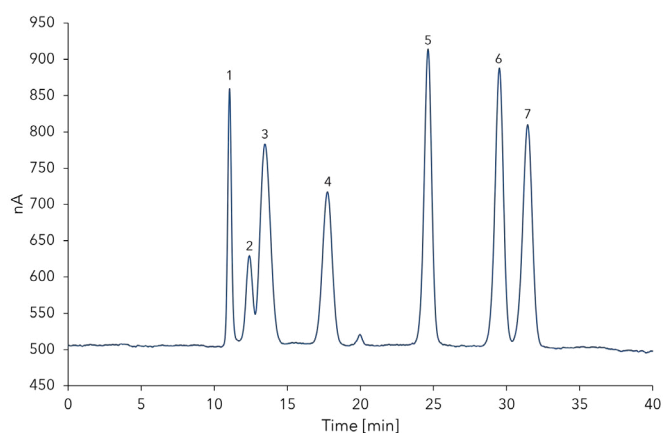
Mannitol (E 421) and sorbitol (E 420) have about half the intensity of saccharose, while xylitol (E 967) has a quite equal intensity as commonly used sugar<sup>2</sup>. In KNAUER application [VFD0160](#) the separation of saccharose, sucralose, glucose, fructose, mannitol, xylitol and sorbitol was performed and detection was carried out via the measurement of the refractive index using the AZURA RID 2.1L. The following application reproduces the measurements using electrochemical detection with post column sodium hydroxide addition to enhance the sensitivity.



# Increasing sensitivity of carbohydrate analysis by switching from refractive index to electrochemical detection

## RESULTS

For electrochemical detection of carbohydrates, the use of sodium hydroxide is necessary, either as mobile phase or applied via post column addition. Eurokat polymer columns are usually operated at a temperature of 60 - 75 °C. However, the measuring cell of the ECD can be operated in a temperature range from 10 - 40 °C. The great temperature difference from column to ECD cell caused a drifting baseline. To stabilize the baseline and minimize the temperature gradient, the column temperature was set to 60 °C. A 5-point calibration in a range from 1.00 to 10.00 µg/mL for the seven compounds was recorded. The calibration curves showed a very good linearity with  $R^2 > 0.9996$  for all analytes. Fig. 1 shows the mixed standard at a concentration of 8.00 µg/mL.



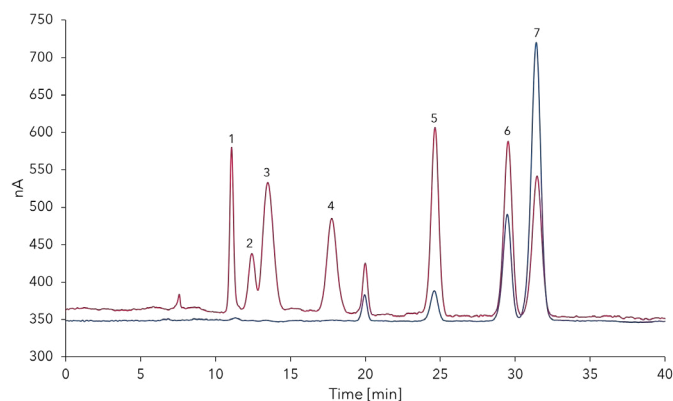
**Fig. 1** Mixed standard at a concentration of 8.00 µg/mL. 1 - saccharose, 2 - sucralose, 3 - glucose, 4 - fructose, 5 - mannitol, 6 - xylitol, 7 - sorbitol.

Based on the measurement of the lowest calibration point 1.00 µg/mL, the limit of detection (LOD) and limit of quantification (LOQ) was calculated. For LOD a signal-to-noise ratio (S/N) of  $S/N=3$  was taken as basis and  $S/N=10$  for LOQ. The following Tab. 1 summarizes the calculated values for each compound.

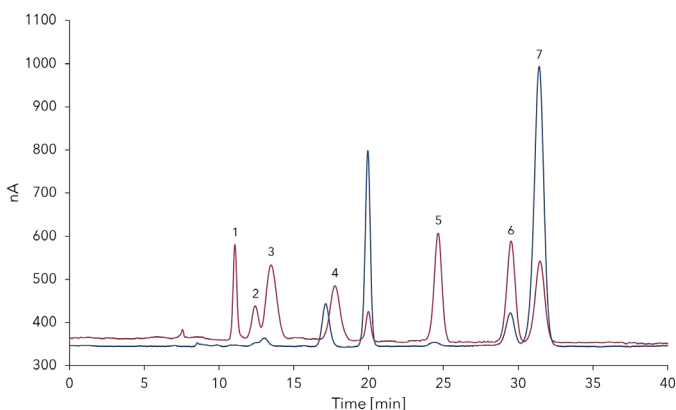
**Tab. 1** Calculated LOD and LOQ values

Substance	LOD (S/N=3) [µg/mL]	LOQ (S/N=10) [µg/mL]
Saccharose	0.07	0.25
Sucralose	0.23	0.77
Glucose	0.10	0.32
Fructose	0.13	0.44
Mannitol	0.07	0.22
Xylitol	0.07	0.23
Sorbitol	0.09	0.29

Referring to application note VFD0160 connatural samples of chewing gum and toothpaste were extracted. Fig. 2 and Fig. 3 show an overlay of the mixed standard and the extracted samples.



**Fig. 2** Overlay of mixed standard (red) and extracted chewing gum (blue). 1 - saccharose, 2 - sucralose, 3 - glucose, 4 - fructose, 5 - mannitol, 6 - xylitol, 7 - sorbitol.



**Fig. 3** Overlay of mixed standard (red) and extracted toothpaste (blue). 1 - saccharose, 2 - sucralose, 3 - glucose, 4 - fructose, 5 - mannitol, 6 - xylitol, 7 - sorbitol.

## RESULTS

The amount of sugar and sugar substitutes in the samples was calculated in g/100g. **Tab. 2** shows the results of sample measurement. The chewing gum contains high amounts of xylitol and sorbitol. Furthermore, mannitol was detected but none of the other sugars. This goes along with the available product information. The extracted toothpaste sample also contains xylitol and sorbitol. Again, this correlates to the provided product data. Unfortunately, no detailed information about the exact amounts of sugars and

sugar substitutes in the analysed samples is available.

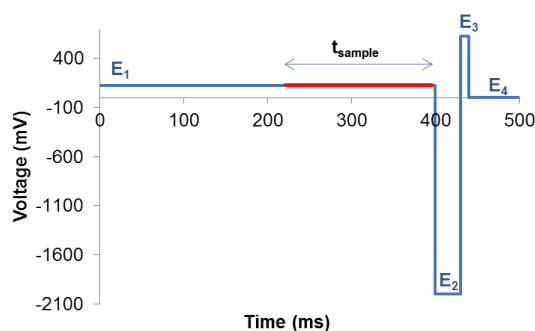
**Tab. 2** Results of sample measurements (n.d. = not detected)

Peak	Compound	Chewing gum in g/100g	Toothpaste in g/100g
1	Saccharose	n.d.	n.d.
2	Sucralose	n.d.	n.d.
3	Glucose	n.d.	n.d.
4	Fructose	n.d.	n.d.
5	Mannitol	3.42	0.49
6	Xylitol	11.98	3.00
7	Sorbitol	37.68	28.65

## SAMPLE PREPARATIONS

Before running the system, it was passivated with 20% nitric acid at a flow rate of 1mL/min for about 30 minutes. Afterwards it was flushed with water until the pH was neutral. The mobile phase for post column addition was prepared in plastic flasks using a 50% (w/w) carbonate free NaOH stock solution. After diluting with water to 200 mM, the sodium hydroxide eluent was transferred to a plastic bottle. The eluent was degassed using ultra sonication and additionally vacuum filtrated. To keep the eluent carbon dioxide free, a filter was installed on top of the bottle. All prepared standards were dissolved in deionized water.

For ECD detection a SenCell high sensitivity electrochemical flow cell with a gold working electrode was used and operated at 40 °C. The column temperature was set to 60 °C. The ECD was operated in pulsed mode using a 4-step PAD potential waveform (**Fig 4**).



**Fig. 4** 4-step PAD potential waveform for the detection of monosaccharides and other carbohydrates, the sample detection occurs during the highlighted time period  $t_{\text{sample}}$

5 g of the chewing gum or toothpaste sample were weighed into a conical flask. Then 50 mL of deionized water were added. The flask was heated under stirring to about 50 °C for approximately 20 minutes. After cooling to room temperature, the extract was filtered through a 0.45  $\mu\text{m}$  syringe filter. After dilution 1:2000 with water, 20  $\mu\text{L}$  of the sample were injected.

## CONCLUSION

The calibration determined in KNAUER application note VFD0160 using refractive index detection lies in a range from 0.25 mg/mL up to 2.00 mg/mL. Using the electrochemical detector ECD 2.1 it was possible to calibrate a range which is about 250 times lower. That makes it possible to detect even residues of carbohydrates in food, beverages and other products. Hence, the applied method is suitable for quality control of sugar free or "light" labelled products for example, where very low concentrations of carbohydrates must be determined. A striking benefit over already published methods using electrochemical detection is the use of the same column as with the refractive index detector. Therewith, a very wide range of concentrations on the same, very long-lasting column can be analysed.

## MATERIALS AND METHODS

**Tab. 3** Instrument setup

Column temperature	60 °C
Injection volume	20 µL
Injection mode	Partial loop
Detection	ECD

**Tab. 4** Pump parameter

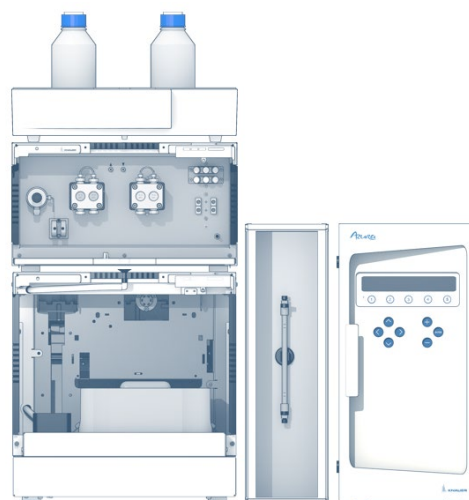
Eluent (A)	Water
Flow rate	0.5 mL/min
Post column eluent (B)	200 mM sodium hydroxide
Post column flow rate	0.8 mL/min
Gradient	Isocratic

**Tab. 5** ECD settings (PAD)

E1	0.10 V	t1	0.04 s
E2	-2.00 V	t2	0.02 s
E3	0.60 V	t3	0.01 s
E4	-0.10 V	t4	0.02 s
Cell temperature	40 °C	ts	200 ms
Range	1 µA		
Polarity	+		
Compensation	On		
AST position	2		
Filter	0.02 Hz		

**Tab. 6** System configuration

Instrument	Description	Article No.
Pump	AZURA P 6.1L, HPG	<a href="#">APH35EA</a>
Autosampler	AZURA AS 6.1L	<a href="#">AAA00AA</a>
Detector	AZURA ECD 2.1	<a href="#">A1651</a>
Flow cell	SenCell - HyREF (Pd/H2) Reference electrode/Au Working electrode	<a href="#">A1652-3</a>
Thermostat	AZURA CT 2.1	<a href="#">A05852</a>
Column	Eurokat Ca, 300 x 8 mm ID	<a href="#">30GX360EKN</a>
Software	ClarityChrom 8.1 - Workstation, autosampler control included	<a href="#">A1670</a>
Software	ClarityChrom 8.1 - System Suitability Extension (SST)	<a href="#">A1677</a>



## REFERENCES

- [46] Zygler, A., Wasik, A., Kot-Wasik, A., Namieśnik, J. Determination of nine high-intensity sweeteners in various foods by high-performance liquid chromatography with mass spectrometric detection. *Anal Bioanal Chem* 400(7):2159-2172 (2011).
- [47] Kuhner, P. Kennzeichnung von Zusatzstoffen. Bundeszentrum für Ernährung <https://www.bzfe.de/inhalt/kennzeichnung-von-zusatzstoffen-1881.html> (February 6, 2020).

## RELATED KNAUER APPLICATIONS

[VFD0160](#) - Determination of sugars and natural sugar substitutes in different matrices

[VFD0183](#) - Sensitivity boost - comparison of electrochemical and refractive index detection for sugar analysis



# Eurokat column coupling for carbohydrate analysis



Juliane Böttcher, Kate Monks; [applications@knauer.net](mailto:applications@knauer.net)  
KNAUER Wissenschaftliche Geräte GmbH, Hegauer Weg 38, 14163 Berlin; [www.knauer.net](http://www.knauer.net).

## SUMMARY

Based on a sulfonated cross-linked styrene divinylbenzene copolymer, the ionic forms Pb and Ca are best suited for the analysis of small carbohydrates up to DP 4. No organic solvents are needed what makes these columns an excellent choice for food applications<sup>1</sup>.

## INTRODUCTION

Carbohydrate analysis is a challenging topic due to the different possible modes, columns, and detection techniques. The easiest and most robust method is an isocratic analysis combined with refractive index detection using polymer-based columns. Although, the total analysis time is often longer with polymer-based columns, they stand out with excellent pH stability and

longevity as well as good results for peak resolution. The Eurokat columns combine two different separation mechanisms: size exclusion and ligand exchange. When it comes to critical peak pairs, it is easily possible to couple Eurokat columns in sequence to extend the separation range. This was applied to separate a complex mixture of six carbohydrates in just one run.



# Eurokat column coupling for carbohydrate analysis

## RESULTS

The first experiments were carried out using only one of the Eurokat Pb columns with a dimension of 300 x 8 mm ID. A mixed standard of sucrose, maltose, and lactose was injected as sample (Fig. 1).

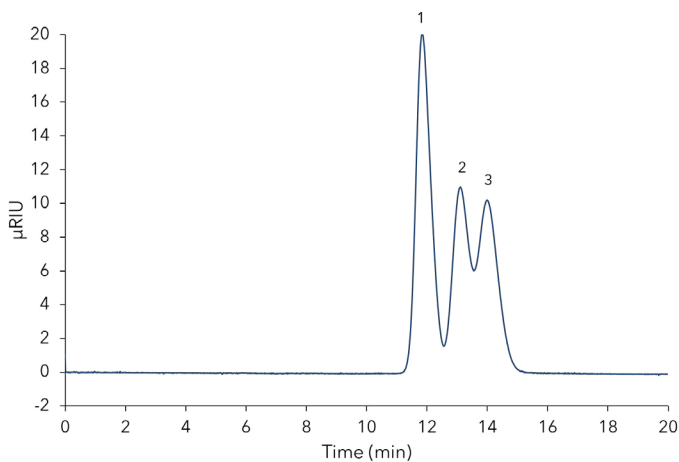


Fig. 1 Mixed standard on one Eurokat Pb column. 1 - sucrose, 2 - maltose, 3 - lactose.

As depicted, maltose and lactose are poorly separated. A qualitative identification is possible, but no useful quantification can be carried out. Therefore, to enhance the resolution of maltose and lactose, a second Eurokat column of the same dimensions and ionic form was coupled in sequence, creating a column tandem. The column coupling significantly improves the resolution between maltose and lactose (Fig 2).

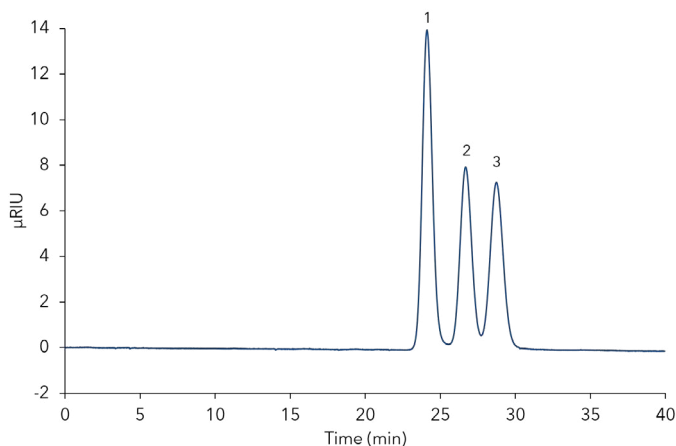


Fig. 2 Mixed standard on two Eurokat Pb columns. 1 - sucrose, 2 - maltose, 3 - lactose.

Also, in comparison the resolution improves in general for all neighboring peaks (Fig. 3).

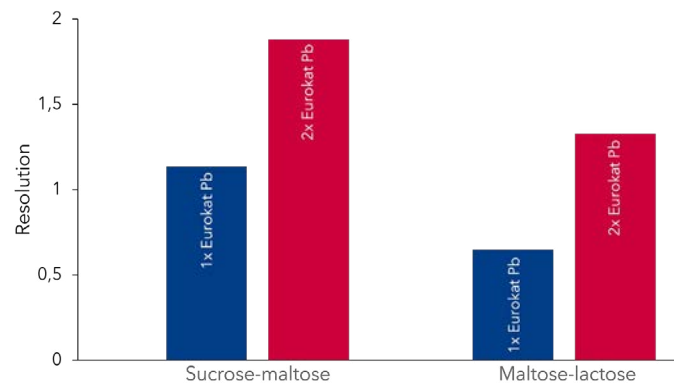


Fig. 3 Comparison of the resolution.

Furthermore, three more analytes were added for a second mixed standard of finally six carbohydrates, which was measured with the Eurokat Pb column tandem as well (Fig. 4).

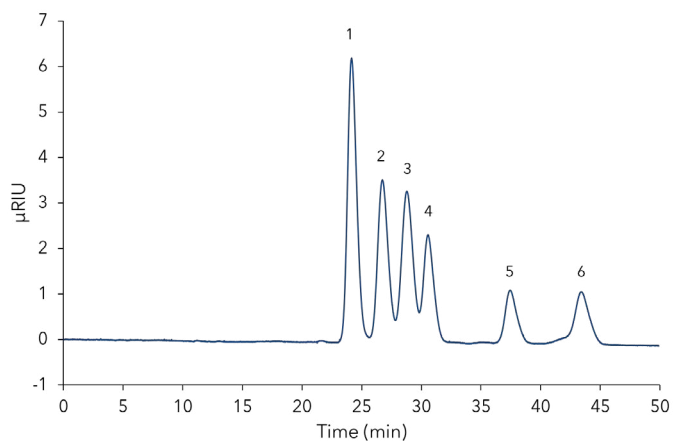


Fig. 4 Mixed standard on column coupling Eurokat Pb (2x). 1 - sucrose, 2 - maltose, 3 - lactose, 4 - glucose, 5 - galactose, 6 - fructose.

## SAMPLE PREPARATIONS

All standards were dissolved in deionized water. The concentration of the single standards lay in a range of  $\beta = 4\text{-}6$  mg/ml.

## CONCLUSION

Maltose and lactose were poorly separated using only one column. Due to the extension of the separation range with the coupling of two Eurokat Pb columns the total run time was prolonged, but it was possible to nearly achieve baseline separation of these two analytes. The addition of glucose decreases the general results for resolution, but the separation is still sufficient to clearly quantify all six analytes.

## MATERIALS AND METHODS

**Tab. 1** Method

Column temperature	75 °C
Injection volume	10-20 µl
Injection mode	Partial loop
Detection	RID
Data rate	20 Hz
Time constant	0.05 s

**Tab. 2** Pump program

Eluent (A)	Water
Flow rate	0.5 ml/min
Gradient	Isocratic

**Tab. 3** System configuration

Instrument	Description	Article No.
Pump	AZURA P6.1L, isocratic	<a href="#">APH31EA</a>
Autosampler	AZURA AS 6.1L	<a href="#">AAA01AA</a>
Detector	AZURA RID 2.1L	<a href="#">ADD31</a>
Thermostat	AZURA CT 2.1	<a href="#">ATC00</a>
Column	2 x Eurokat Pb, 300 x 8 mm ID	<a href="#">30GX350EKN</a>
Software	ClarityChrom 8.2.3 - workstation, autosampler control included	<a href="#">A1670</a>



## REFERENCES

[48] KNAUER Wissenschaftliche Geräte. <https://www.knauer.net/en/eurokat-pb-10-um-column-300-x-8-mm/p13997> (2020/13/10).

## RELATED KNAUER APPLICATIONS

[VFD0169](#) - Determination of sugars in honey - comparison of refractive index and light scattering detection

[VFD0184](#) - Everything solved - Carbohydrate content in instant coffee with PAD

# Quantitative determination of gallic acid and tannic acid from gallnut extract



Juliane Böttcher, Kate Monks; applications@knauer.net

KNAUER Wissenschaftliche Geräte GmbH, Hegauer Weg 38, 14163 Berlin; www.knauer.net

## SUMMARY

*Quercus infectoria gallae* (oak gall) contain tannins which are characterized to have curative and anti-inflammatory properties. Because of their antiviral and antibacterial qualities, tannins from gallnut extracts have been used in traditional and ayurvedic medicine as well as beauty culture. A newly developed gallnut extract was prepared in a glycerin-water-mixture. To examine the quality of this extract a reliable, innovative HPLC method was worked out to determine the containing active ingredients.

## INTRODUCTION

Tannins or tanning agents are natural occurring phenolic plant compounds highly abundant in bark, roots, and leaves. Their main operation area is to support the healing process of inflammations, abscesses, incinerations, wounds [4], atopic skin [6], as well as quinsy [1, 5]. The effect of tannins is antibacterial, antiviral [2], antifungal [3] anti-inflammatory, astringent and toxin neutralizing. Tanning agents are divided into three groups: gallotannins, algae tanning agents and catechol tanning agents. Gallic acid, also known as 3,4,5-trihydroxybenzoic acid, is a component of the gallotannins and found highly concentrated in

gallnuts and oak bark. Tannic acid is a specific commercial form of tannin. The chemical formula for tannic acid is often given as  $C_{76}H_{52}O_{46}$ , which corresponds with decagalloyl glucose, but in fact it is a mixture of polygalloyl glucoses or polygalloyl quinic acid esters with a varying number of galloyl moieties per molecule. The following application shows how to determine and quantify gallic acid and tannic acid from gallnut extract with an HPLC method. Since tannic acid was defined as a mixture its determination was carried out as a sum parameter.



# Quantitative determination of gallic acid and tannic acid from gallnut extract

## RESULTS

For the quantitative determination of gallic acid and tannic acid five different measuring points were defined. After calibration the limit of detection (LOD) and the limit of quantification (LOQ) were determined. For gallic acid a LOD of 12 ng/mL and LOQ of 40 ng/mL was achieved. For tannic acid a LOD of 120 ng/mL and LOQ of 400 ng/mL was calculated. The next step was to measure the sample. The gallnut extract consist of a mixture of glycerol and water and had a strong yellow, almost brown dye. Because of the extract's viscosity a direct injection into the HPLC system was not possible. A dilution series was made and a final dilution with water in a relation of 1:1000 was chosen. The extract was filtered through a 0.45  $\mu\text{m}$  pore size hydrophilic

filter. For the evaluation of gallic acid and tannic acid pretreated samples with different injection volumes were measured. Gallic acid was analyzed with an injection volume of 10  $\mu\text{L}$  whereas an injection volume of 1  $\mu\text{L}$  was used for determining the sum parameter tannic acid. **Fig 1 and 2** show the measurements of the diluted extract at different injection volumes. Furthermore replicates of the filtered and diluted (1:1000) extract were measured with 1  $\mu\text{L}$  and 10  $\mu\text{L}$  injection volume. The samples are evaluated on the based calibration curves. The replicates show reproducible results. Relating to the detected area the relative standard deviation for the measurements ( $n=4$ ) is 1.94 % RSD for gallic acid and 0.51 % RSD for tannic acid.

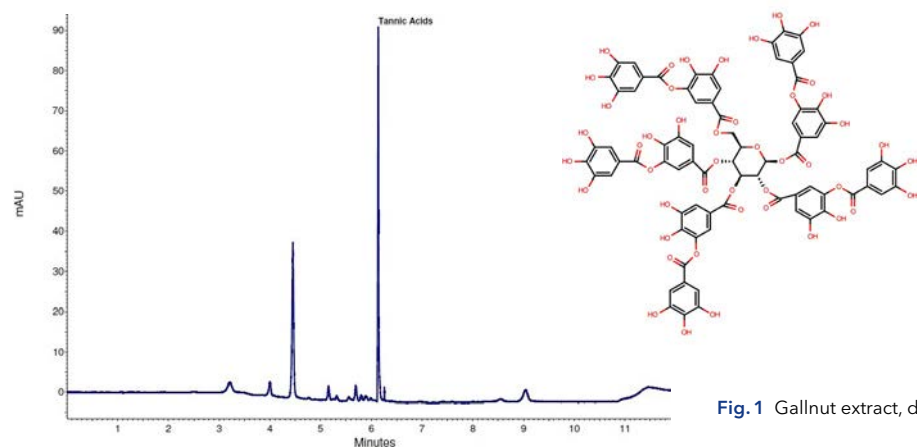


Fig. 1 Gallnut extract, dilution 1:1000, 1  $\mu\text{L}$  injection.

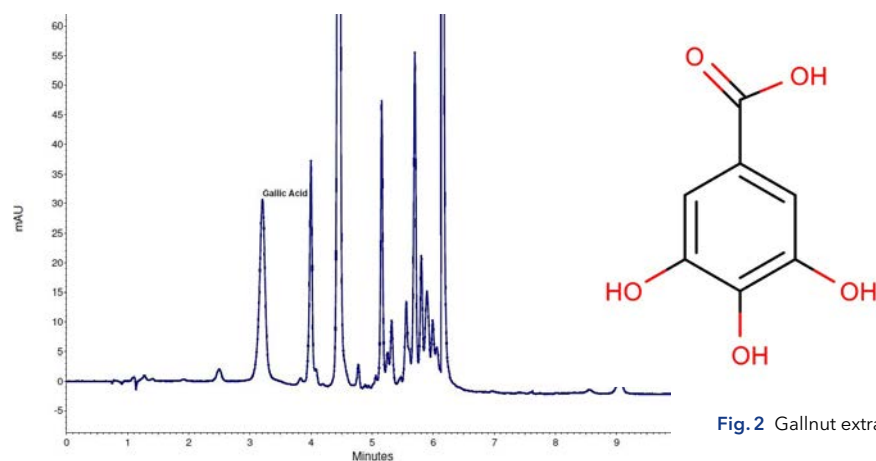


Fig. 2 Gallnut extract, dilution 1:1000, 10  $\mu\text{L}$  injection

## MATERIALS AND METHODS

An AZURA Analytical HPLC Plus system for a pressure range up to 700 bar was used for this application. It consists of a P 6.1L HPG pump, an autosampler 3950, a CT 2.1 column thermostat and DAD 6.1L. The analytical method runs with a gradient mode at a flow rate of 1 mL/min. The mobile phase is a mixture of water and acetonitrile/water 50:50 (v/v). An amount of 0.1 % of formic acid is used as mobile phase modifier. The column thermostat was set to 30 °C and the detector recorded at 280 nm. The used column is filled with Eurospher II 100-3 C18H silica.

## CONCLUSION

With this developed method and the AZURA® HPLC Plus system it is possible to perform a rapid quantitative analysis of gallic acid and tannic acid without time-consuming sample preparation. Despite of the complex matrix like the gallnut extract, the quantification could be performed robustly and reproducibly with the specified method parameters. To exploit the full potency of gallic acid a preparative purification of the extract is possible. For the processing of the purified product it has to be solved in glycerol, water or a mixture of those solvents. Because of the presence of acidic modifier and methanol in the analytical method it cannot be adapted directly up to a preparative dimension. A possible preparative method should be applied immediately after the gallnut extraction and should be run with 100 % watery eluent. KNAUER's developed analytical method still can be used for quality and purity control.

## REFERENCES

- [1] Savitri Shrestha, Vasuki Srinivas Kaushik, Ravi Shankara Birur Eshwarappa, Sundara Rajan Subaramaihha, Latha Muuaiah Ramanna, and Dhananjaya Bhadrappura Lakkappa, *Asian Pac J Trop Biomed.* 4(1): 35-39, 2014 Jan.
- [2] Kyoko Ueda, Ryoko Kawabata, Takashi Irie, Yoshiaki Nakai, Yukinobu Tohya, Takemasa Sakaguchi, *PLoS ONE* 8(1): e55343, 2013.
- [3] Nur Saeida Baharuddin, Hasmah Abdullah, Wan Nor Amilah Wan Abdul Wahab, *J Pharm Bioallied Sci.* 7(1): 15-20, 2015 Jan-Mar.
- [4] Umachigi SP, Jayaveera KN, Ashok Kumar CK, Kumar GS, Vrushabendra swamy BM, Kishore Kumar DV, *Tropical Journal of Pharmaceutical Research:* 7 (1): 913-919, March 2008.
- [5] Upadhye AS, *Pharm Anal Acta.* , 2010.
- [6] Jung MK, Hur DY, Song SB, Park Y, Kim TS, Bang SI, Kim S, Song HK, Park H, Cho DH, *J Invest Dermatol.* 130(5):1459-63., 2010 May.



## ADDITIONAL RESULTS

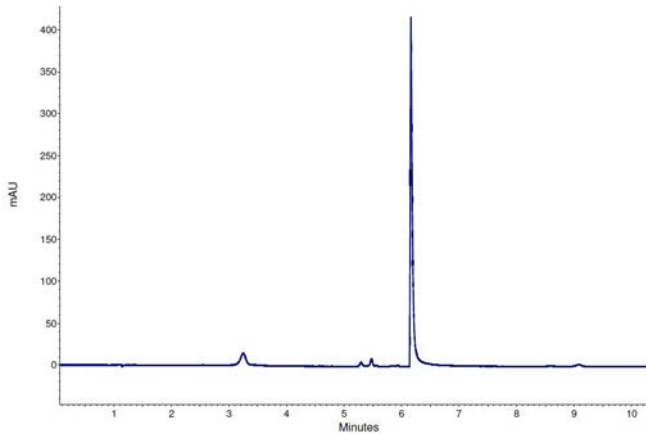


Fig. A1 Chromatogram Gallic acid,  $\beta=0.01$  mg/mL

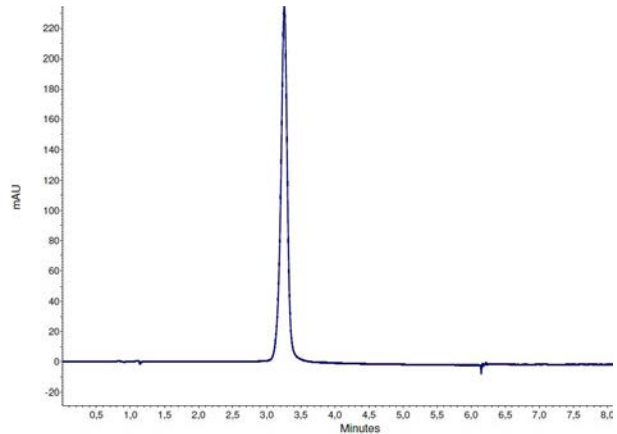


Fig. A2 Chromatogram Tannic acid,  $\beta=0.01$  mg/mL

## ADDITIONAL MATERIALS AND METHODS

Tab. A1 Method parameters

Eluent A	H <sub>2</sub> O <sub>dd</sub> +0.1 % formic acid		
Eluent B	Acetonitrile: H <sub>2</sub> O <sub>dd</sub> 50:50 (v/v) +0.1 % formic acid		
Gradient	Time [min]	% A	% B
	0.00	95	5
	2.00	95	5
	5.00	55	45
	5.02	0	100
	10.00	0	100
	10.02	95	5
	15.00	95	5
Flow rate	1 mL/min	System pressure	-
Column temperature	30 °C	Run time	15 min
Injection volume	1-10 $\mu$ L	Injection mode	-
Detection wavelength	280 nm	Data rate	20 Hz
		Time constant	0.05 sec

Tab. A2 System configuration & data

Instrument	Description	Article No.
Pump	AZURA P 6.1L, HPG, 10 mL, SS	<a href="#">APH35EA</a>
Autosampler	Autosampler 3950	<a href="#">A50070</a>
Detector	AZURA DAD 6.1L	<a href="#">ADC11</a>
Flow cell	LightGuide 50mm, 6 $\mu$ L	<a href="#">AMD59</a>
Thermostat	AZURA CT 2.1	<a href="#">A05852</a>
Eluent tray	AZURA E 2.1L	<a href="#">AZC00</a>
Column	Vertex Plus Column, 150x3mm, Eurospher II 100-3 C18H	<a href="#">15XE185E2G</a>
Software	OpenLAB CDS EZChrom Edition	<a href="#">A2600-1</a>



# Quality control of pharmaceutical solutions by determination of osmolality

Juliane Böttcher, Till Myrach, Kate Monks; applications@knauer.net  
KNAUER Wissenschaftliche Geräte GmbH, Hegauer Weg 38, 14163 Berlin; www.knauer.net



## SUMMARY

The osmolality of solutions used in the clinical and pharmaceutical field is an important issue that requires regular monitoring. Especially infusion solutions but also solutions for external use like eye drops and rinsing solutions must be isotonic to ensure the physical well-being of humans. In this study, the osmolality of commercially available pharmaceutical solutions were determined using the KNAUER K-7400S Semi-Micro Osmometer.

## INTRODUCTION

To guarantee the quality of solutions used for pharmaceutical or medical purposes the osmolality is consulted as an assessment value. The osmolality is a general measure for the number of solved molecules in a liquid and is commonly given in mOsmol/kg. Conventionally used solutions for clinical application are for example Ringer solution [1], physiological salt solution (0.9 % NaCl), and 5 % glucose. These have to be in the osmolality range of  $290 \pm 10$  mOsmol/kg to

comply with human plasma [2]. In addition to these physiological infusions also glucose solutions of higher concentration (10 %, 15 % and 20 %) are used in daily clinical practice. These are for instance applied for the treatment of hypoglycemic conditions or as carbohydrate component in parenteral nutrition [3]. All of the mentioned solutions were prepared and analysed to evaluate their actual osmolalities.

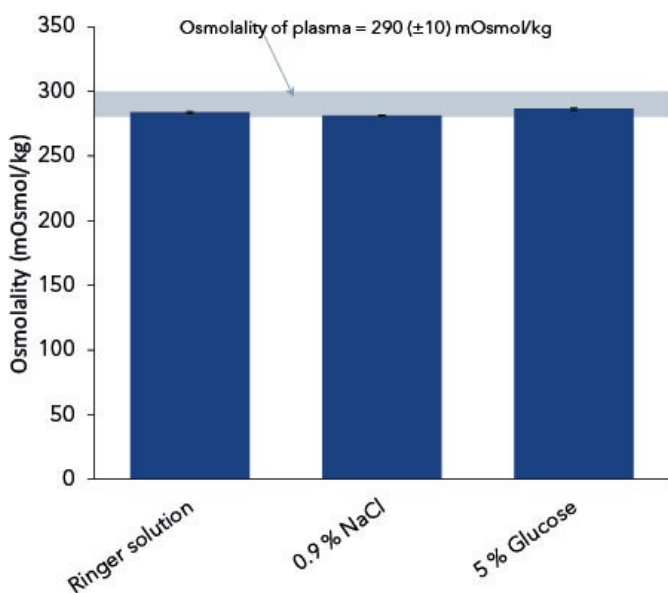


# Quality control of pharmaceutical solutions by determination of osmolality

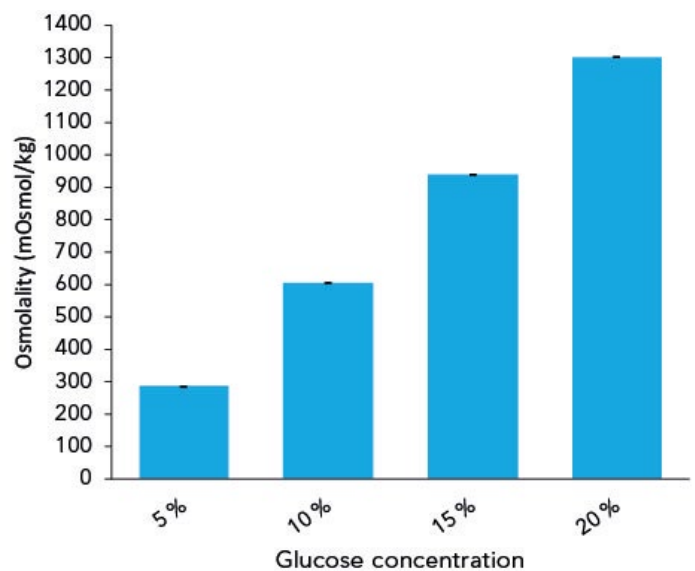
## RESULTS

To evaluate the results, they were divided into the different fields of application. On the one hand the isotonic solutions used for infusion or rinsing, and on the other hand the glucose solutions with varying concentrations for special treatments. The 5 % glucose solution is somehow an exception and could be applied for both ambits. The diagram in **Fig 1** shows the measurement of the isotonic solutions in relation to

the given limit value for plasma. The averaged osmolality (n=10) for Ringer solution was 284 mOsmol/kg, 281 mOsmol/kg for 0.9 % NaCl and 287 mOsmol/kg for 5 % glucose. The diagram in **Fig 2** visualizes the measured osmolalities of different glucose solutions with concentrations of 5 %, 10 %, 15 % and 20 % glucose. The determined averaged osmolality (n=10) added up to 604 mOsmol/kg for 10 %



**Fig. 1** Measured osmolalities of pharmaceutical infusion solutions. Graph shows average values and standard deviations of 10 replicates.



**Fig. 2** Measured osmolalities of different glucose solutions. Graph shows average values and standard deviations of 10 replicates.

## MATERIALS AND METHODS

All measurements were made with the KNAUER K-7400S Semi-Micro Osmometer. The used calibration standards had osmolality values of 300, 400, 850, and 2000 mOsmol/kg. The system parameters were set to -8 °C for freeze and -16 °C for cooling limit. All prepared solutions were degassed using an ultrasonic bath to remove the carbon dioxide. Then 150 µL of the samples were transferred to a plastic sample tube.

## CONCLUSION

The measured results for all isotonic solutions are within the given limit value for human plasma of  $290 \pm 10$  mOsmol/kg. This is interesting as most manufacturers of pharmaceutical solutions only state the theoretical osmolalities of their products. The theoretical osmolality of physiological salt solution is specified as 308 mOsmol/kg. However, as shown in the analysis, the real osmolality is clearly lower (281 mOsmol/kg). Especially for more complex infusion solutions, a verification of the real osmolalities is therefore highly recommended since the deviation to the theoretical value might be even higher. Unless there are no limit values of osmolality for higher concentrated glucose solutions, the measurements can be used as a good example to show that the comportment of osmolality is not linear.

## REFERENCES

- [1] <http://flexikon.doccheck.com/de/Ringer-L%C3%B6sung>
- [2] <https://www.gesundheit.gv.at/labor/laborwerte/niere-harn/osmolalitaet>
- [3] <https://www.serag-wiessner.de/fileadmin/redakteur/PDF/informationen/I3714AAF.pdf>



## ADDITIONAL RESULTS

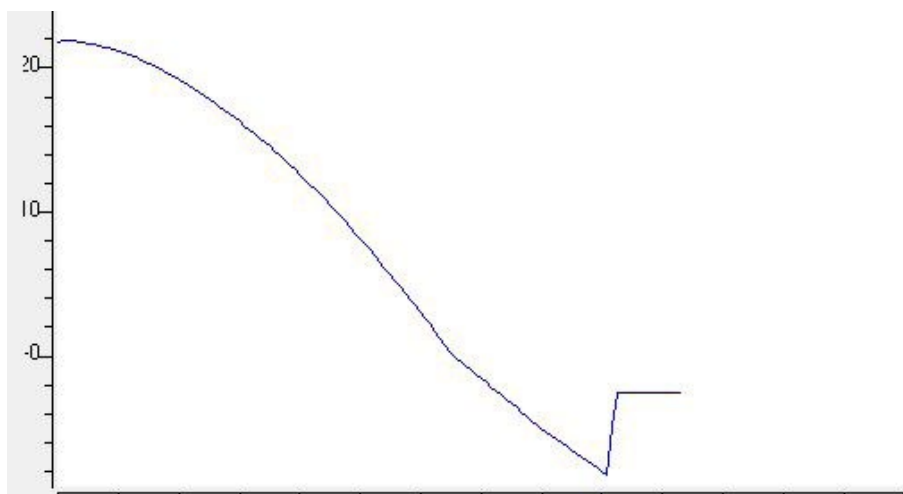


Fig.A1 Temperature-time-curve

## ADDITIONAL MATERIALS AND METHODS

Tab.A1 Method parameters

Calibration 1	0 mOsmol/kg	300 mOsmol/kg	400 mOsmol/kg
Calibration 2	0 mOsmol/kg	300 mOsmol/kg	850 mOsmol/kg
Calibration 3	0 mOsmol/kg	850 mOsmol/kg	2000 mOsmol/kg
Sample volume	150 µL		
Freeze	-8 °C		
Cooling limit	-16 °C		

Tab.A2 System configuration & data

Instrument	Description	Article No.
Osmometer	KNAUER K-7400S Semi-Micro Osmometer	<a href="#">A0006AC</a>
Sample tubes	Approved plastic sample tubes, 500 pcs.	<a href="#">A0272</a>
Software	EuroOsmo 7400	<a href="#">A3705</a>

## RELATED KNAUER APPLICATIONS

[VPH0064](#) - Quality control of pharmaceutical solutions by determination of osmolality

# Traditional Chinese Medicine meets modern analytics – HPLC fingerprinting for the comparison of *Radix paeonia alba* and *Radix paeonia rubra*

Juliane Böttcher, Kate Monks; applications@knauer.net  
KNAUER Wissenschaftliche Geräte GmbH, Hegauer Weg 38, 14163 Berlin; www.knauer.net



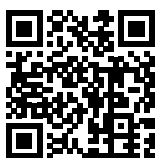
## SUMMARY

In Traditional Chinese Medicine (TCM) *Radix paeonia alba* (white peony root) and *Radix paeonia rubra* (red peony root) are important herbs used in many different preparations. [1] To ensure the identification of both cultivations an HPLC fingerprint was developed to work out the differences between red and white peony root products.

## INTRODUCTION

White (Bai shao) and red peony root (Chi shao) belong to the Paeoniaceae family, so both are variants of the same species. Red peony root is gathered in the wild while the white peony root is cultivated. The Chinese names do not refer to the color of the bloom but to the color of the root. The main functions of Chi shao in TCM practices are the removal of pathogenic heat from blood and invigorate blood to remove blood stasis. Its most important uses and indications are for example measles in epidemic heat syndrome, hematemesis, nosebleed, discharging fresh blood stool, sore red swollen eyes, swelling, abscesses and boils, and many more. The usual dosage is from 6 to 12 grams,

generally in decoction [2]. The white peony root is best used as a tonic for blood and as a “heat reducing” (or “heat removing”) herb for the liver. According to Traditional Chinese Medicine methodology and theory, white peony root for instance helps with abdominal pain and muscular spasms. The benefits continue: Chinese medicine practitioners also believe it also has an astringent effect on sweating, and is also antibacterial, antispasmodic, and anti-inflammatory in nature. [3] Because of having different superior benefits, a specific differentiation is important to gain a proper application of these herbal medicines.

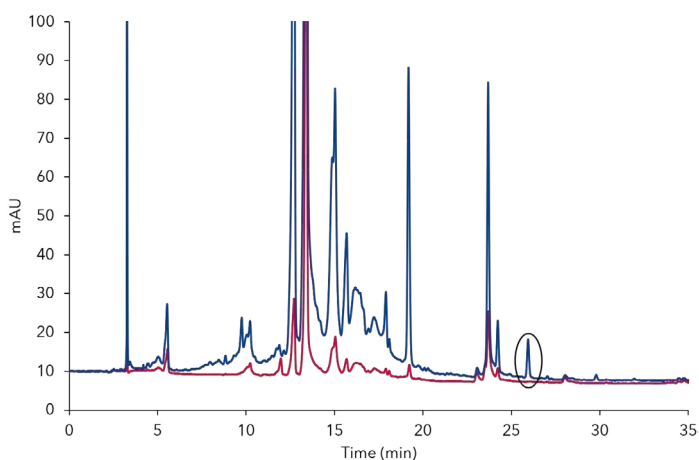


# Traditional Chinese Medicine meets modern analytics – HPLC fingerprinting for the comparison of *Radix Paeonia alba* and *Radix Paeonia rubra*

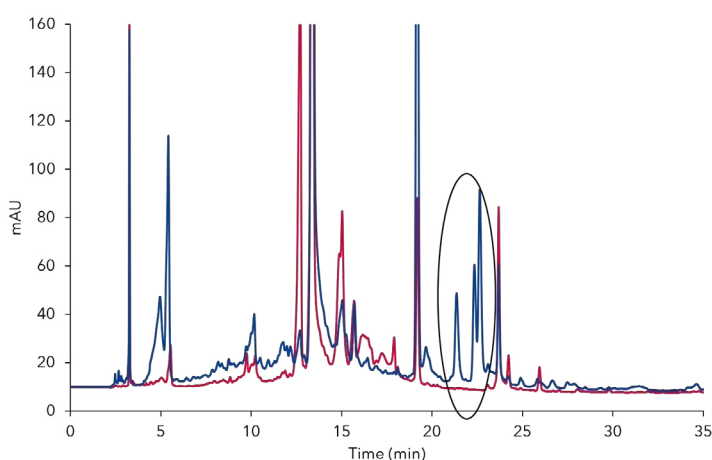
## RESULTS

Samples of peony root have been analyzed to differ between red and white peony extracts of plant origin. Furthermore, extracts of peony granulate were measured and compared to the plant origin samples to make statement about the affiliation to either *Radix Paeonia rubra* or *Radix Paeonia alba*. Additionally, the main active component paeoniflorin, which is present in both cultivations, was identified by the measurement of an analytical standard. **Fig. 1** shows an enhanced overlay of the plant origin extracts of *Paeonia rubra* and *Paeonia alba*. Paeoniflorin was detected at 13.40 minutes. The trace of *Paeonia rubra* shows a

characteristic peak at a retention time of 26 minutes, which is not found in the *Paeonia alba* sample. For a better peak identification in the samples the 3D data is also considered for evaluation. The absorption spectra of the tagged peaks are shown in the additional results section of this application note. **Fig. 2** shows an overlay of *Paeonia rubra* granulate and *Paeonia rubra* plant extract. Here a group of three peaks is found in the granulate but missing in the plant origin sample. Again, the recorded 3D data was used for examination. (see additional results section)



**Fig. 1** Enhanced overlay of *Paeonia rubra* (blue) and *Paeonia alba* (red) plant extracts, tagged peak at 26 min



**Fig. 2** Overlay *Paeonia rubra* granulate (blue) and *Paeonia rubra* plant extract (red), tagged peaks from 21.3 min to 22.7 min

## MATERIALS AND METHODS

The analysis was performed using an AZURA HPLC Plus system consisting of an AZURA AS 6.1L autosampler, an AZURA CT 2.1 column thermostat, an AZURA P 6.1L LPG pump and an AZURA DAD 2.1L diode array detector equipped with 10 mm, 10  $\mu$ L PressureProof flow cell cartridge. The eluent was a composition of A: water + 0.05 % phosphoric acid and B: acetonitrile. A linear gradient was used with a total run time of 70 min including equilibration time. The column thermostat was set to 40°C. The traces were detected at 230 nm. Additionally, 3D data was recorded over a range from 190 nm to 700 nm. The samples were injected as ethanolic extracts. Before injection the samples were diluted with ethanol in a ratio of 1:10. The used column in a dimension 250 x 4.6 mm ID with precolumn was filled with Eurospher II 100-5 C18 P silica.

## REFERENCES

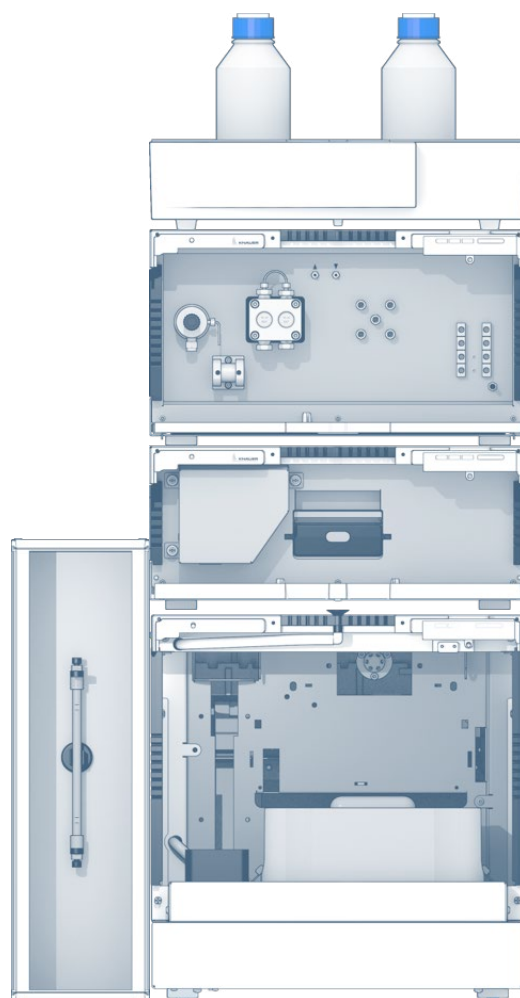
[1] Chunnian H, Yong P, Yuxiong F, Bing P, Zhe W, Peigen X. Quick comparison of Radix Paeonia Alba, Radix Paeonia Rubra, and Cortex Moutan by high performance liquid chromatography coupled with monolithic columns and their chemical pattern recognition. *Pharmacognosy Magazine*. 2012;8(31):237-243. doi:10.4103/0973-1296.99290.

[2] <http://www.chineseherbshealing.com/red-peonies-chi-shao-yao/>

[3] <https://mydaolabs.com/blogs/the-way/white-peony-root-bai-shao>

## CONCLUSION

The differentiation between the white and red peony root plant extracts is given, referring to the characteristic peak at a retention time of 26 minutes. Also, the difference between Paeonia rubra granulate and plant extract can also be determined via this method. The HPLC fingerprint profile of the Paeonia alba granulate and plant origin sample is very similar and only differs in the paeoniflorin concentration. A characteristic peak was not found here. However, as well the Paeonia rubra granulate as the Paeonia rubra plant extract show characteristics which are not found in the Paeonia alba samples. Therefore, a correlation of granulates and plant extracts to the cultivation is possible.



## ADDITIONAL RESULTS

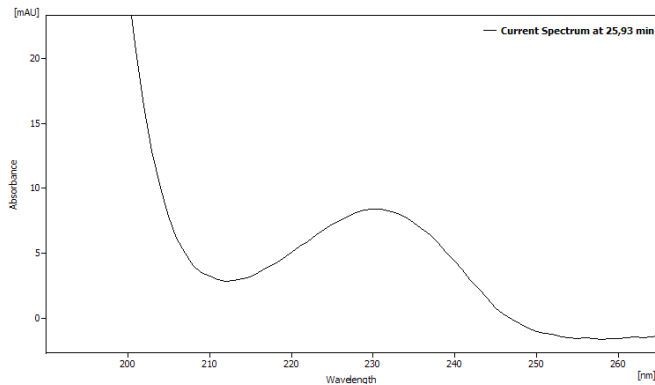


Fig.A1 Absorption spectrum of Paeonia rubra sample at 26 min

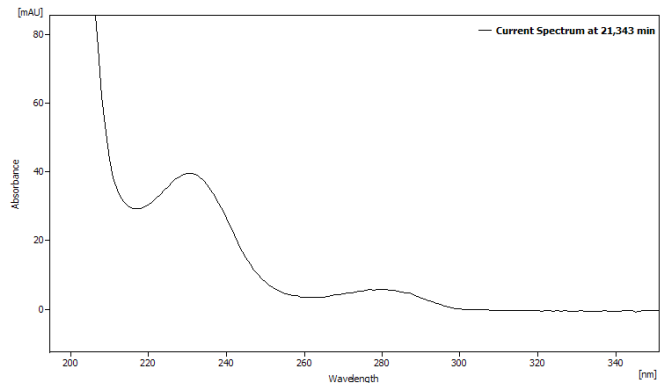


Fig.A2 Absorption spectrum of Paeonia rubra granulate at 21.34 min

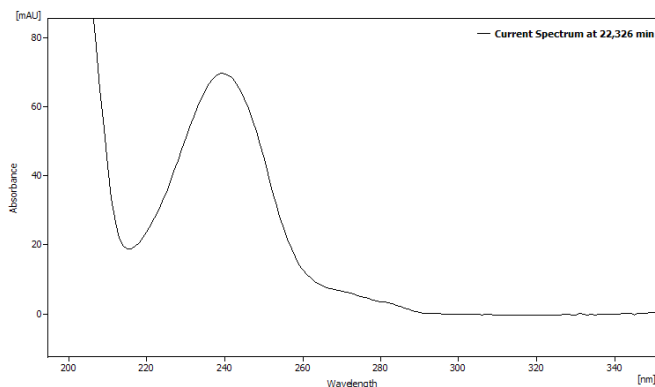


Fig.A3 Absorption spectrum of Paeonia rubra granulate at 22.30 min

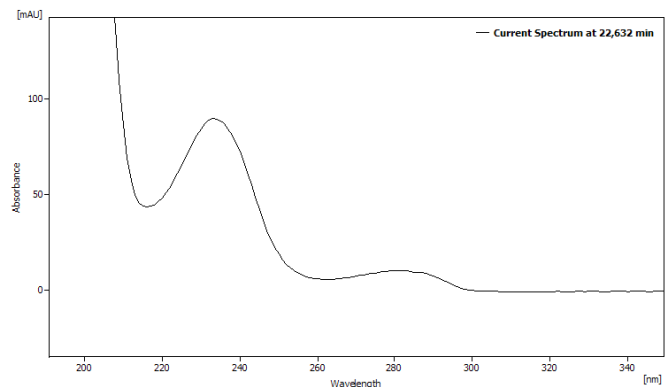


Fig.A4 Absorption spectrum of Paeonia rubra granulate at 22.60 min

## ADDITIONAL MATERIALS AND METHODS

Tab.A1 Method parameters

Eluent A	Water + 0.05 % phosphoric acid		
Eluent B	Acetonitrile		
Gradient	Time [min]	% A	% B
	0	95	5
	60	0	100
	60.02	95	5
	70	95	5
Flow rate	1.0 mL/min	System pressure	100 bar
Run temperature	40°C	Run time	70 min
Injection volume	10 µL	Injection mode	Partial loop
Detection wavelength	230 nm	Data rate	20 Hz
		Time constant	0.05 s

Tab.A2 System configuration & data

Instrument	Description	Article No.
Pump	AZURA P 6.1L, LPG	<a href="#">APH39EA</a>
Autosampler	AZURA AS 6.1L	<a href="#">AAA00AA</a>
Detector	AZURA DAD 2.1L	<a href="#">ADC01</a>
Flow cell	Analytical KNAUER PressureProof UV Flow Cell Cartridge, 10 mm, 10 µl	<a href="#">-AMC38</a>
Column thermostat	AZURA CT 2.1	<a href="#">A05852</a>
Column	Vertex Plus Column, Eurospher II 100-5 C18 P, 250 x 4.6 mm ID with precolumn	<a href="#">25VE182E2J</a>
Software	ClarityChrom 7.4.2 - Workstation, autosampler control included ClarityChrom 7.4.2 - PDA extension	<a href="#">A1670</a> <a href="#">A1676</a>

## RELATED KNAUER APPLICATIONS

[VPH0063](#) - Quantitative determination of gallic acid and tannic acid from gallnut extract

[VPH0055J](#) - Determination of Ginsenosides (I)

[VFD0103J](#) - Separation of Bisabolol oxide A and B from Camellia extract

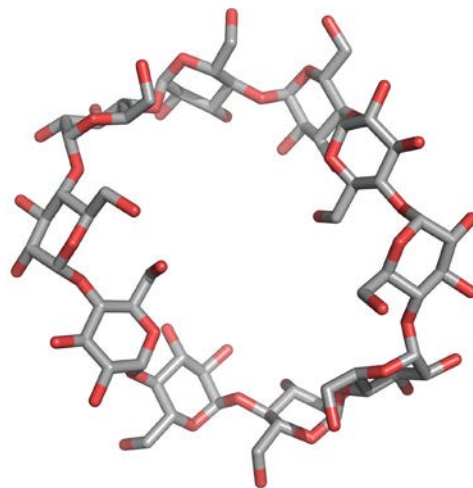


# Cyclodextrin purification (Part 1): Method screening and overload studies

Yannick Krauke\*, Sebastian Thürmann\*, Christian Sonnendecker\*\*,  
Kate Monks\* – applications@knauer.net

\*KNAUER Wissenschaftliche Geräte GmbH, Hegauer Weg 38,  
14163 Berlin – www.knauer.net

\*\* Fakultät für Lebenswissenschaften / Institut für Biochemie AG  
Mikrobiologie und Bioverfahrenstechnik,  
Johannisallee 21-23, 04103 Leipzig



## SUMMARY

Cyclodextrins (CD) are macrocyclic compounds composed of five or more glycopyranosides. These ring structures can function as micro-capsules. An automated column screening was applied for method development to find best separation conditions of a CD mixture. Finally, an optimized method for CD purification was established.

## INTRODUCTION

Cyclodextrins (CD) are oligosaccharides of glucopyranose that are bound in a cyclic form of six to at least 12 units. The ring structure can function as micro-capsule for other molecules. Do to their unique chemical structure they can find different applications i. e. as drug carriers, in cosmetics or in food industry. CDs with more than 10 subunits are of special interest as larger molecules can be inserted in these rings.

Therefore, the approaches for synthesis and purification of CD >10 are conducted [1]. Here, a method optimization was performed for the purification of cyclodextrins from biocatalytic synthesis [2]. With an automated column screening an existing method was optimized. Further, mass- and volume overload studies were performed in analytical scale to find best conditions for scale-up to preparative scale.

# Cyclodextrin purification (Part 1): Method screening and overload studies

## RESULTS

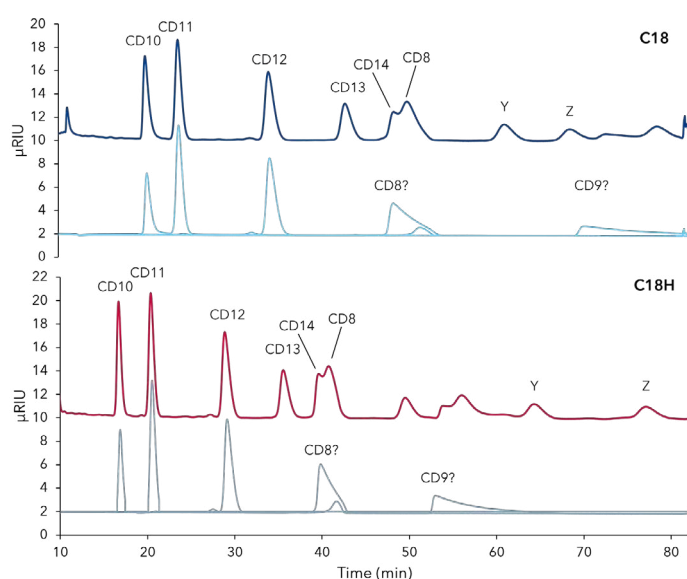
A device with automated column switching valves was used for sequentially testing of four different stationary phases: C18, C18H, C18A und C18P each 150 x4 mm, 5  $\mu$ m particles and 2.5 % methanol (Fig. A1, additional results). The C18 and C18H showed the best separation profile among tested columns. Separation with water on aqueous C18A and C18AP revealed no promising results.

Next, the columns length was investigated and revealed that the relevant peaks had a better separation factor on a 250 mm then 150 mm long columns (Fig. A2, additional results). The 150 mm length column is good for analysis but for preparative applications the 250 mm column is required.

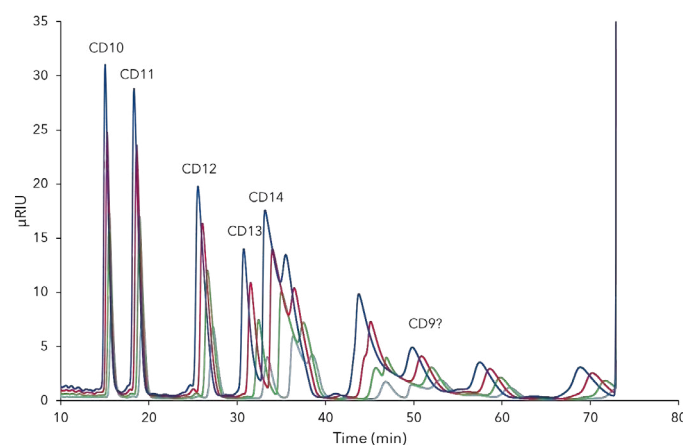
Comparison of different methanol concentrations revealed that 5 % methanol was too high as nearly all peaks eluted together within the first 10 min (not shown). At 3 % methanol one additional peak (Fig. A3; CD13, additional results) was detected which was

not found at 2.5 % methanol on C18 column (Fig. A3), revealing that accurate eluent preparation is essential for this method.

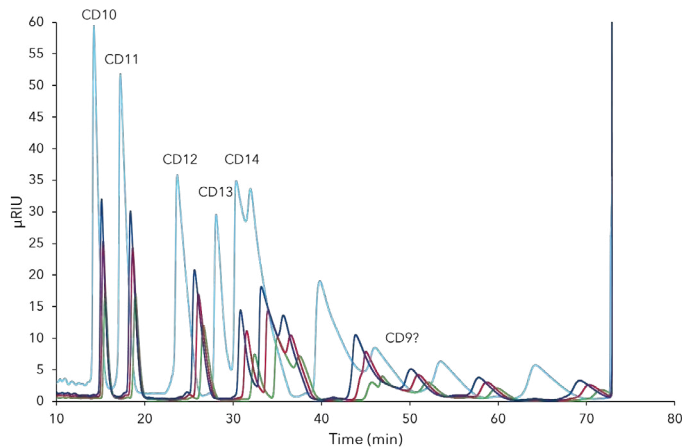
The final separation profile comparison of the CDmix on C18 and C18H revealed that the C18H column is the better choice for purification of cyclodextrins due to earlier elution of target peaks (Fig. 1). Four relevant cyclodextrins were baseline separated (Fig. 1). A mass and volume overload studies were performed prior to preparative scale-up. Four different concentrations (25, 50, 75, 100 mg/mL) of the CD mix were tested and results showed that even at 100 mg/mL CD10, CD11 and CD12 were baseline separated (Fig. 2). Next, different volumes (50, 75, 100, 200  $\mu$ L) of 50 mg/mL CD mix were injected. At 100  $\mu$ L the first three peaks were still baseline separated, at 200  $\mu$ L not as well anymore (Fig. 3). The resulting data was used to up-scale the separation for purification on columns with larger ID (see application Cyclodextrine purification - [VPH0068](#)).



**Fig. 1** Comparison of separation profiles from CD mixture and CD standards on C18 (dark blue) and C18H (red) columns (relevant time span of separation shown). CD mixture (30 mg/mL), CD8 (1 mg/mL), CD 12,9,8 mixture (3mg/mL), CD10, 11 mixture (2 mg/mL); Y, Z unidentified peaks; 250x4mm, 5  $\mu$ m, 0.8 mL/min 3 % methanol, 50  $\mu$ L inject



**Fig. 2** Chromatograms of CD mixture mass overload studies; grey - 25 mg/mL, green - 50 mg/mL, red - 75 mg/mL, dark blue - 100 mg/mL; C18 H 250 x 4 mm; 5  $\mu$ m; 0.8 mL/min; 3 % methanol; 25°C; 50  $\mu$ L



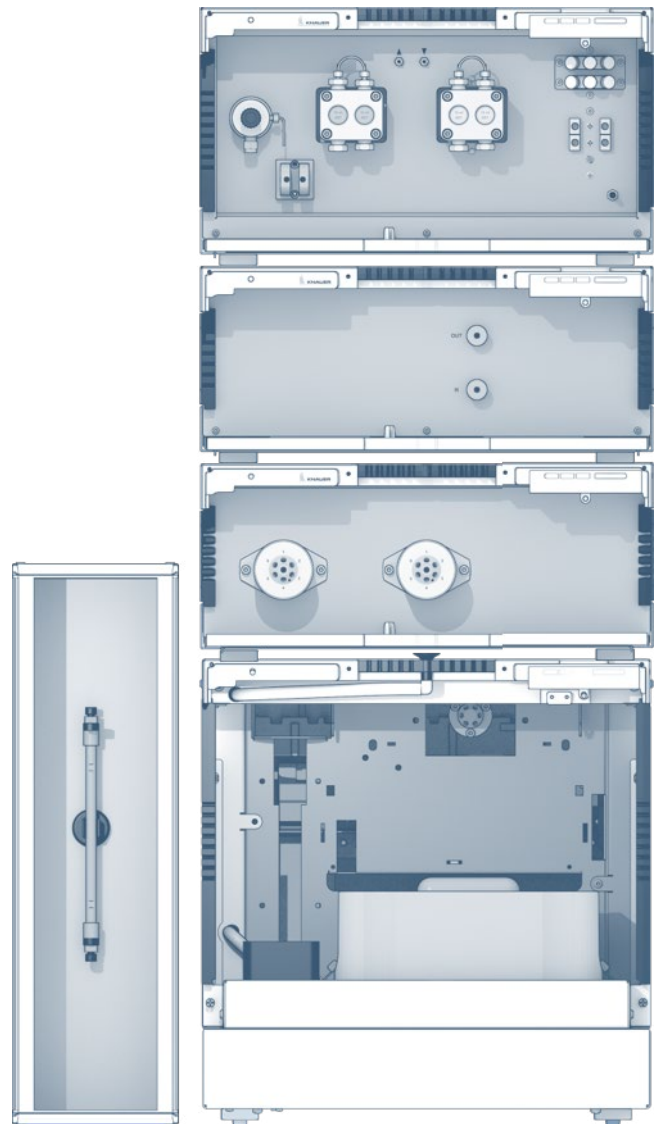
**Fig. 3** Chromatograms of CDmix volume overload studies. green - 50  $\mu$ L, red - 75  $\mu$ L, dark blue - 100  $\mu$ L, light blue - 200  $\mu$ L; C18H 250 x 4 mm; 5  $\mu$ m; 0.8 mL/min; 3 % methanol; 25°C; 50 mg/mL

## MATERIALS AND METHOD

The AZURA HPLC system consisted of AZURA P 6.1L 10 ml HPG sst pump, AZURA AS 6.1L autosampler, AZURA RID 2.1L detector, AZURA Assistant with two 6 port multi-position stainless steel valves for column switching and an AZURA CT 2.1 column thermostat. Final method was as follows: 0.8 mL/min, 25°C, 70 min at 3 % methanol, 10 min at 30 % methanol, 40 min at 3 % methanol.

## CONCLUSION

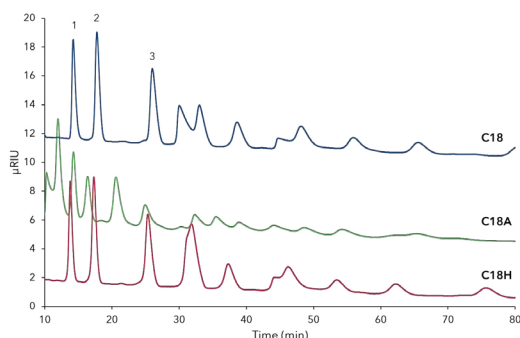
An automated column switching assistant is the optimal device for fast and effective stationary and mobile phase screening. An existing method was optimized with focus on a later up-scaling for purification of CDs. The method will allow to purify CD10, CD11 and CD12 in high purity in batch purification process.



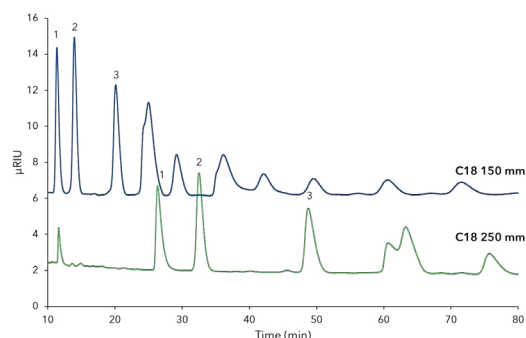
## REFERENCES

- [4] E.M. Martin del Valle (2003), Cyclodextrins and their uses: a review, *Process Biochemistry*, Volume 39, Issue 9, Pages 1033-1046, ISSN 1359-5113
- [5] Sonnendecker, C., Thürmann, S., Przybylski, C., Zitzmann, F. D., Heinke, N., Krauke, Y., Monks, K., Robitzki, A. A., Belder, D. and Zimmermann, W. (2019), Large-Ring Cyclodextrins as Chiral Selectors for Enantiomeric Pharmaceuticals. *Angew. Chem. Int. Ed.*. doi:10.1002/anie.201900911

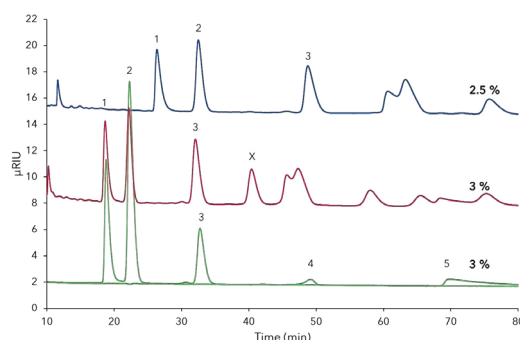
## ADDITIONAL RESULTS



**Fig. A1** Comparison separation of CD mixture (25 mg/mL) on three different stationary phases; blue - C18, green - C18A, red - C18H; 1 - CD10, 2 - CD11, 3 - CD12; all columns 150 x 4mm, 5 µm, 0.8 mL/min, 25°C, 50 µL inject.



**Fig. A2** Comparison separation of CDmix (25 mg/mL) on C18 columns with different lengths; CDmix (25 mg/mL), blue - 150 x 4 mm, green - 250 x 4 mm; 1 - CD10, 2 - CD11, 3-CD12, 5 µm, 0.8 mL/min, 25°C, 50 µL inject



**Fig. A3** Comparison separation of CDmix with 2.5 % and 3 % methanol on C18 column 250 x 4 mm. CDmix (25 mg/mL), blue - 2.5 % methanol, red - 3.0 %, green - standards at 3.0 % methanol; 1) CD10, 2) CD11, 3) CD12, 4) CD8, 5) CD 9; 5 µm; 0.8 mL/min; 25°C; 50 µL

## ADDITIONAL MATERIALS AND METHODS

**Tab. A1** Method parameters

<b>Column temperature</b>	25°C	<b>Detection wavelength</b>	RI
<b>Injection volume</b>	50 µL	<b>Data rate</b>	20 Hz
<b>Injection mode</b>	Partial loop	<b>Time constant</b>	0.05 s

**Tab. A2** Pump parameters

Eluent A	3 % methanol		
Eluent B	30 % methanol		
Flow rate	0.8 mL/min		
Pump program	Time [min]	% A	% B
	0-70	100	0
	70-80	0	100
	80-120	100	0

**Tab. A3** System configuration

Instrument	Description	Article No.
Pump	AZURA P 6.1L, HPG, 10mL, SST	<a href="#">APH35EA</a>
Detector	AZURA RID 2.1L	<a href="#">ADD31</a>
Assistant	Left: 6 MPV Middle: 6 MPV Right: free	
Thermostat	AZURA CT 2.1	<a href="#">A05852</a>
Column	Eurospher II 100-5-C18 150x4mm	<a href="#">15WE181E2J</a>
	Eurospher II 100-5-C18 250x4mm	<a href="#">25WE181E2J</a>
	Eurospher II 100-5-C18H 150x4mm	<a href="#">15WE185E2J</a>
	Eurospher II 100-5-C18H 250x4mm	<a href="#">25WE185E2J</a>
Software	ClarityChrom 7.4.2	<a href="#">A1670</a>

## RELATED KNAUER APPLICATIONS

[VPH0068](#) - Cyclodextrin purification (Part 2): Method transfer and purification

# Easy and fast isolation of rosmarinic acid from lemon balm with mass-directed purification

Jan Wendrich, Yannick Krauke, Lilit Avagyan, Kate Monks; [applications@knauer.net](mailto:applications@knauer.net)  
KNAUER Wissenschaftliche Geräte GmbH, Hegauer Weg 38, 14163 Berlin; [www.knauer.net](http://www.knauer.net)



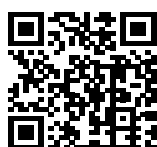
## SUMMARY

Rosmarinic acid is a natural product widely spread over different plant families. Preparative reversed-phase chromatography was used for the mass-directed purification of rosmarinic acid from a lemon balm extract. The AZURA® Prep HPLC system together with the 4000 MiD mass spectrometer was showed to be well suited for this application.

## INTRODUCTION

The ubiquitous natural product rosmarinic acid shows antiviral, antimicrobial and anti-inflammatory characteristics. It is used in different kinds of medicinal products for example in ointments for sports injuries. Leaves of lemon balm contain a high concentration

of rosmarinic acid and are therefore an interesting source for the isolation of this compound. Here, we present an effective and time-saving method for the isolation of rosmarinic acid from a lemon balm extract based on the technique of mass-directed purification.

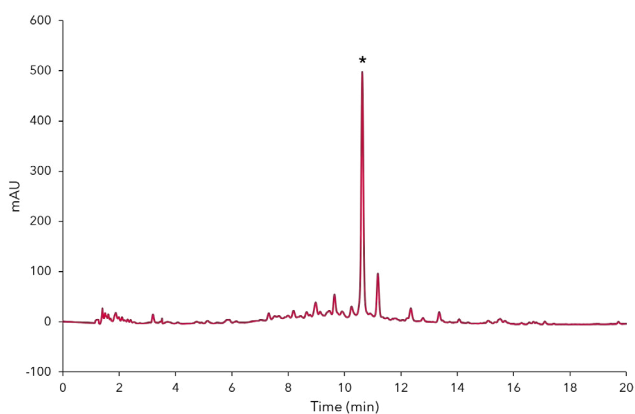


# Easy and fast isolation of rosmarinic acid from lemon balm with mass-directed purification

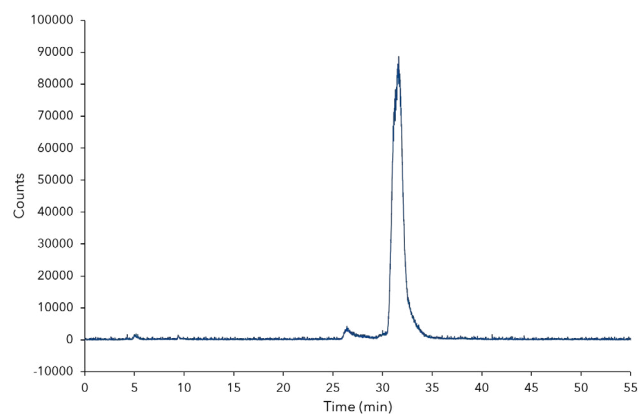
## RESULTS

A method for the isolation of rosmarinic acid from a lemon balm extract was developed on an analytical scale using an AZURA Analytical System and a Eurospher II C18 column (Fig 1). The UV spectra from the analysis showed the presence of many compounds with the structural motif of a phenyl acrylic acids. For a time-saving isolation of the target compound, the developed method was then transferred directly to

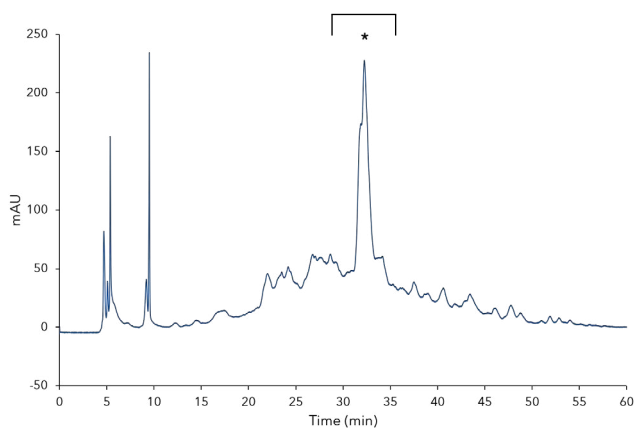
the AZURA Preparative System with the ability to fractionate via molecular mass. One fraction with a compound of the desired mass ( $m/z$  359.2;  $[M-H]^-$ ) was collected (Fig 2 & Fig 3). The following analysis of this fraction with the AZURA Analytical System showed that it was possible to isolate the target compound rosmarinic acid with the technique of mass-directed purification in a purity of >95% (Fig 4).



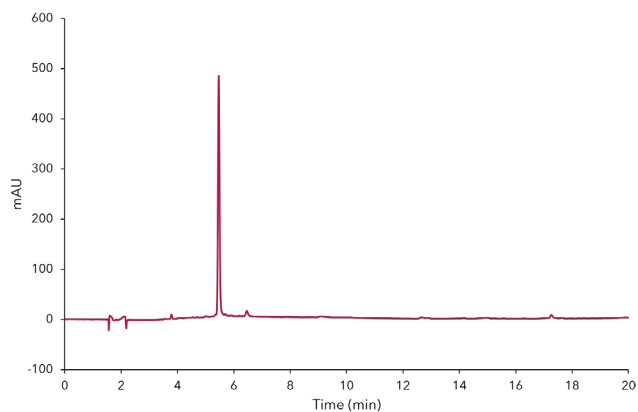
**Fig. 1** Analytical chromatogram of the crude lemon balm extract at 280 nm; gradient separation 20 %-100 % acetonitrile, \*rosmarinic acid peak



**Fig. 2** SIM (single ion monitoring) chromatogram of a purification run for the target mass of  $m/z$  359.2



**Fig. 3** UV-Chromatogram of a purification run for the crude lemon balm extract at 280 nm, \*rosmarinic acid peak



**Fig. 4** Analytical chromatogram of the fraction containing rosmarinic acid at 280 nm, isocratic separation 50/50 water/acetonitrile

## MATERIALS AND METHODS

AZURA Analytical HPLC System was used for the method development consisting of a low-pressure gradient AZURA P6.1L pump, an AZURA AS 6.1L auto-sampler, an AZURA DAD 2.1L diode array detector equipped with a 10 mm PressureProof flow cell and an Eurosphere II 100-5 C18 150 x 4.6 mm column.

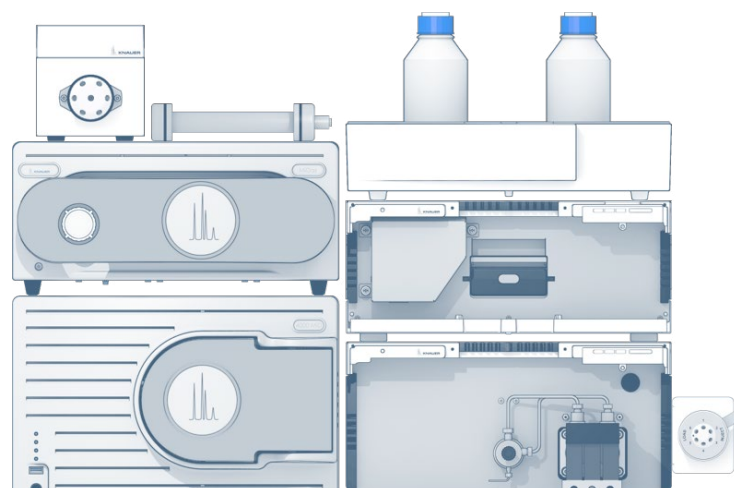
The gradient method was run for 20 min at a flow rate of 1 mL/min starting with 80/20 % water/acetonitrile increasing to 100 % acetonitrile over 20 min. Both eluents contained 0.1 % formic acid as an additive. The wavelength of the detector was set to 280 nm at a data rate of 20 Hz. 10  $\mu$ L of the sample was injected.

AZURA Preparative HPLC System was used for the mass-directed purification of rosmarinic acid. The system consisted of an AZURA P 2.1L pump equipped with a 250 mL pump head and a three channel

low pressure gradient (LPG) ternary module, a manual injection valve (1/8", 6 port 2 kanal) equipped with a 5 mL sample loop, an AZURA DAD 6.1L diode array detector equipped with a 3 mm PressureProof flow cell, a 4000 MiD mass spectrometer with the MiDas sampling unit, a AZURA V 2.1S equipped with a 6 port multi position valve for fractionation and an Eurospher II 100-10 C18 250 x 30 mm column. The gradient method run for 67 min at a flow rate of 21.3 mL/min under the same conditions as the analytical method described above. The wavelength of the DAD was set to 280 nm at a data rate of 10 Hz, while the mass selective detector was set to SIM mode monitoring the relevant mass of  $m/z$  359.2. The data trace of the mass selective detector was used for fractionation via the multi-position valve. 5 mL of the crude extract obtained under sonication from dried leave material with 30 % isopropanol was injected.

## CONCLUSION

Rosmarinic acid was the main metabolite of the extracted lemon balm material. This target molecule was isolated in a short time with an AZURA Preparative HPLC system using the technique of mass-directed purification. By this, the number of fractions was reduced to one leading to a significant decrease of past analysis time.



## ADDITIONAL RESULTS

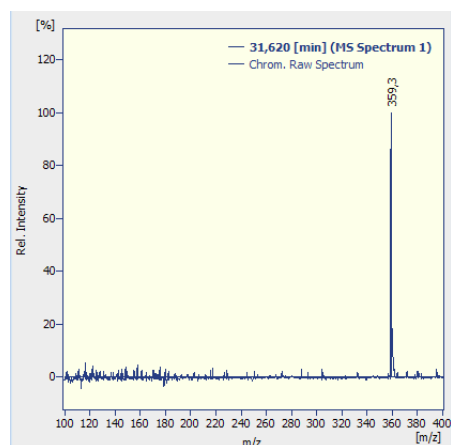


Fig. A1 Mass spectrum of rosmarinic acid ([M-H]-).

## ADDITIONAL MATERIALS AND METHODS

Tab. A1 Method parameters (preparative)

Eluent A	Water + 0.1 % formic acid		
Eluent B	Acetonitrile + 0.1 % formic acid		
Gradient	Time [min]	% A	% B
	0	80	20
	67	0	100
Flow rate	21.3 mL/min	System pressure	100 bar
Run temperature	RT	Run time	67 min
Injection volume	5 mL	Injection mode	Full loop
Detection wavelength	280 nm	Data rate	10 Hz
		Time constant	0.1 s

Tab. A3 System configuration & data (analytical system)

Instrument	Description	Article No.
Pump	AZURA P 6.1L	<a href="#">APH34GA</a>
Autosampler	AZURA AS 6.1L	<a href="#">AAA00AA</a>
Detector	AZURA DAD 2.1L	<a href="#">ADC01</a>
Flow cell	PressureProof Flow cell 10 mm 10 µl	<a href="#">AMC38</a>
Column	Eurospher II 100-5 C18 with precolumn, Vertex Plus Column 150 x 4.6 mm	<a href="#">15VE181E2J</a>
Software	ClarityChrom	<a href="#">A1670</a>
	ClarityChrom 7.4.2 - PDA extension	<a href="#">A1676</a>

Tab. A2 Method parameters (mass spectrometer analysis)

Scan mode	Interleave (Scan/SIM)
Mass range	100-400 m/z
Scan rate	1 Hz
Step	0.2
SIM	359.2 m/z
Ion mode	Negative
Gas flow	2.5 L/min

Tab. A4 System configuration & data (preparative system)

Instrument	Description	Article No.
Pump	AZURA P 2.1L 250 mL	<a href="#">APE20LA</a>
	AZURA LPG module for Pump P 2.1L	<a href="#">AZZ00AB</a>
Injection	AZURA V 2.1S Valve 6 Port 2 Position	<a href="#">A1359</a>
Sample loop	5 mL Sample loop	<a href="#">A0586-2</a>
Detector	AZURA DAD 6.1L	<a href="#">ADC11</a>
Flow cell	PressureProof flow cell 3 mm 2 µL	<a href="#">AMB18</a>
Mass spectrometer	4000 MiD with MiDas	<a href="#">A66900</a>
Fractionation	AZURA V 2.1S Valve 6 Port Multiposition	<a href="#">AWA10BC</a>
Software	ClarityChrom	<a href="#">A1670</a>
	ClarityChrom PDA Extension	<a href="#">A1676</a>
	ClarityChrom MS Extension	<a href="#">A1679</a>
	ClarityChrom FRC control module	<a href="#">A1682</a>
Column	VertexPlus AX Column 250x30 mm Eurospher II 100-10 C18	<a href="#">25QE181E2N</a>



## Cyclodextrin purification (Part 2): Method transfer and purification

Yannick Krauke\*, Sebastian Thürmann\*, Christian Sonnendecker\*\*,  
Kate Monks\* – applications@knauer.net

\*KNAUER Wissenschaftliche Geräte GmbH, Hegauer Weg 38,  
14163 Berlin – www.knauer.net

\*\* Fakultät für Lebenswissenschaften / Institut für Biochemie AG  
Mikrobiologie und Bioverfahrenstechnik,  
Johannisallee 21-23, 04103 Leipzig



### SUMMARY

Cyclodextrins (CD) are macrocyclic compounds composed of five or more glycopyranosides. These ring structures can function as micro-capsules. Hence, CDs often find interesting applications in drug delivery. In this application, five CDs were purified in high purity from a CD mixture derived from a biocatalytic synthesis.

### INTRODUCTION

Cyclodextrins (CD) are oligosaccharides of glucopyranose that are bound in a cyclic form of five to up to 12 units. The ring structure can function as a micro-capsule for other molecules. Due to their unique chemical structure they find different applications i. e. as drug carriers, in cosmetics, or in food industry. High amounts of CDs with more than 10 sub-

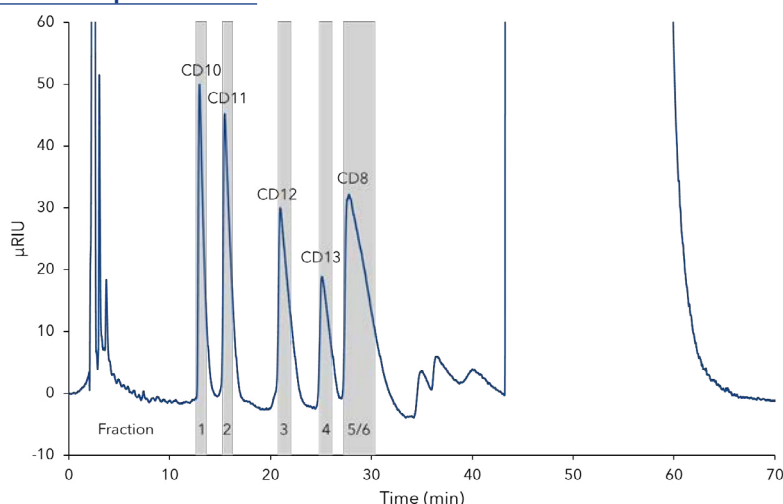
units (CD>10) are of special interest since larger molecules can be inserted into their rings [1]. Therefore, new approaches for synthesis and purification especially of CD >10 are conducted increasingly. A purification method previously developed in analytical scale was here transferred to preparative scale (KNAUER application note [VPH0066](#)).

# Cyclodextrin purification (Part 2): Method transfer and purification

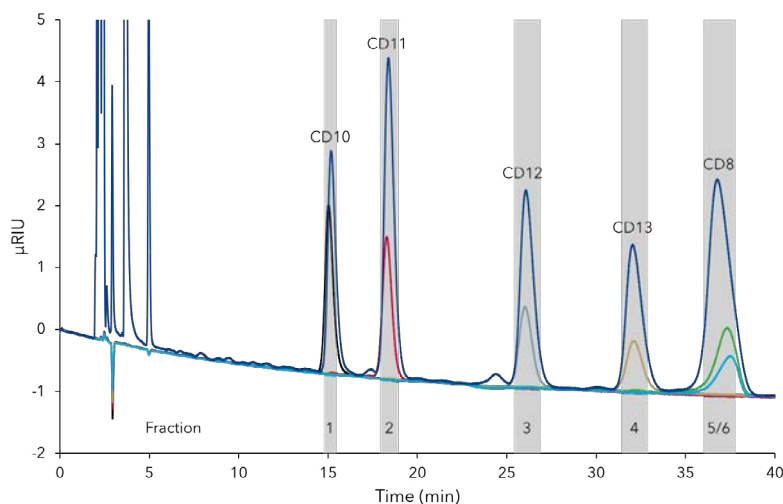
## RESULTS

The method parameters for cyclodextrin purification were developed and optimized prior in analytical scale (see application note [VPH0066](#)). The mass and volume overload studies revealed that 100  $\mu\text{L}$  injections of 100 mg/mL cyclodextrin mixture would still allow highly pure purification of at least four cyclodextrin ([VPH0066](#)). A linear scale-up from analytical to preparative scale was performed. The column length and particle size remained the same (250 mm; 5  $\mu\text{m}$ ), the inner diameter was increased from 4 mm to 20 mm. The [KNAUER scale up converter](#) was used

for fast determination of preparative method parameters, the flow rate was increased to 20 mL/min and sample injection volume to 2 mL. The chromatogram of the preparative CD mix run showed baseline separation of five CD peaks ([Fig. 1](#)). These five peaks were collected using the threshold function of PurityChrom software exceeding a certain  $\mu\text{RIU}$  value. Chromatograms from samples of each fraction were compared to chromatogram of the whole CD mixture. The overlay clearly showed that all fractions were 100 % pure and no contamination from neighbor peaks ([Fig. 2](#)).



**Fig. 1** Separation of CDmix on C18H 250x20mm column, 2 mL injection, 100 mg/mL CD mix; indication of collected fractions



**Fig. 2** Overlay analytical chromatograms of CDmix and the fractions collected from purification step ([Fig. 1](#)) black Frc1; red Frc2, light blue Frc3, yellow Frc4, green and blue Frc5/Frc6

## MATERIALS AND METHOD

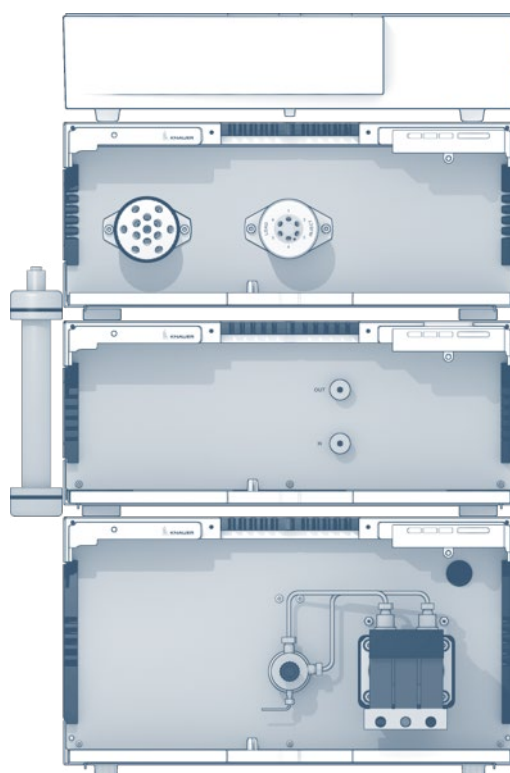
The AZURA Preparative HPLC system consisted of AZURA P2.1L 100 mL sst pump with ternary LPG module, AZURA RID 2.1L high flow detector and AZURA assistant module with 12 port multi position 1/8" sst valve (fractionation), 6 port 2 position 1/16" sst injection valve and P4.1S 50 ml sst feed pump. Final purification method was as follow: 20 mL/min, RT, 40 min 3% methanol, 14 min 30% methanol, 20 min 3 % methanol. Peaks were fractionated with threshold function over  $\mu$ RIU signal. Fraction analysis was performed with AZURA analytical RI system as described in application note [VPH0066](#).

## CONCLUSION

A previously in analytical scale developed purification method for cyclodextrine was transferred to semi-preparative scale by linear scale-up. Five cyclodextrines were purified in nearly 100 % purity and the results showed that higher loading would be possible without to much loss in purity. The preparative refractive index detector AZURA RID 2.1L HighFlow allowed detection at flow rates of 20 mL/min without using a flow splitter thus facilitating the purification process. All together a new approach for cyclodxtrine purification was developed.

## REFERENCES

- [6] E.M.Martin Del Valle, Cyclodextrins and their uses: a review, *Process Biochemistry*, Volume 39, Issue 9, 2004, Pages 1033-1046,ISSN 1359-5113
- [7] Sonnendecker, C. , Thürmann, S. , Przybylski, C. , Zitzmann, F. D., Heinke, N. , Krauke, Y. , Monks, K. , Robitzki, A. A., Belder, D. and Zimmermann, W. (2019), Large-Ring Cyclodextrins as Chiral Selectors for Enantiomeric Pharmaceuticals. *Angew. Chem. Int. Ed.*. doi:10.1002/anie.201900911



## ADDITIONAL RESULTS

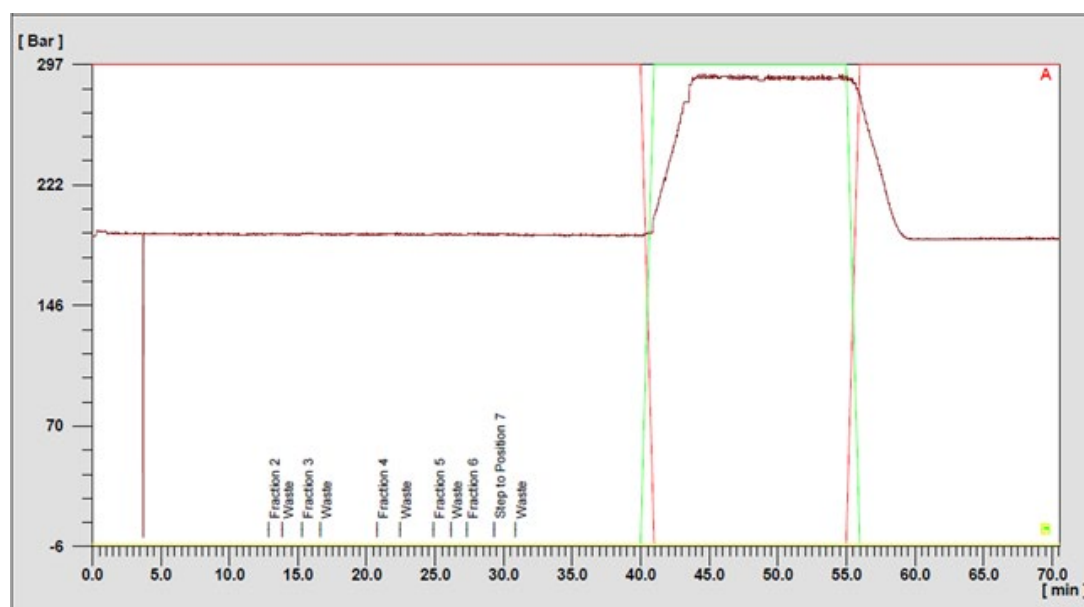


Fig.A1 Pressure fractionation, prep run

## ADDITIONAL MATERIALS AND METHODS

Tab.A1 Method parameters

Column temperature	RT	Detection wavelength	RI
Injection volume	2 mL	Data rate	20 Hz
Injection mode	Full loop	Time constant	0.05 s

Tab.A2 Pump parameters

Eluent A	3 % methanol		
Eluent B	30 % methanol		
Flow rate	20 mL/min		
Pump program	Time [min]	% A	% B
	0-40	100	0
	40-55	0	100
	55-75	100	0

Tab.A3 System configuration

Instrument	Description	Article No.
Pump	AZURA P2.1L, 100 mL, SST	<a href="#">APE20KA</a>
	AZURA LPG ternary module for Pump P 2.1L	<a href="#">AZZ00AB</a>
Detector	AZURA RID 2.1L High flow	<a href="#">ADD38</a>
Assistant	Left: 12Mpos,1/8",sst Middle:6Port2Pos,1/16",sst Right:P4.1S, 50ml,sst	<a href="#">AYFAEABR</a>
Column	Eurospher II 100-5 C18H 250x20mm	<a href="#">25PE185E2J</a>
	Eurospher II 100-5 C18H 30x20mm	<a href="#">03PE185E2J</a>
	Eurospher II 100-5 C18H 250x4mm	<a href="#">25WE185E2J</a>
Software	PurityChrom basic	<a href="#">A2650</a>
	KNAUER Scale up converter	<a href="#">A1696</a>

## RELATED KNAUER APPLICATIONS

[VPH0066](#) - Cyclodextrin purification (Part 1): Method screening and overload studies

# Analyzing cannabis flowers according to the German Pharmacopeia - monograph 2017

Lisa Loxterkamp, Kate Monks; applications@knauer.net  
KNAUER Wissenschaftliche Geräte GmbH, Hegauer Weg 38, 14163 Berlin; www.knauer.net



## SUMMARY

Since the change in German law in 2017 (§1 Abs. 1, BtMG) [1] the need for reliable and robust HPLC methods for quality control has drastically increased. Six common cannabinoids of high medicinal interest cannabidiol (CBD), cannabidiolic acid (CBDA), cannabinol (CBN),  $\Delta^8$ -tetrahydrocannabinol ( $\Delta^8$ -THC),  $\Delta^9$ -tetrahydrocannabinol ( $\Delta^9$ -THC), and  $\Delta^9$ -tetrahydrocannabinolic acid ( $\Delta^9$ -THCA) were quantified using the AZURA® HPLC plus system according to the monography of German Pharmacopeia [2]. Three different reversed phase columns were screened for robustness for the method verified in the subsequent step. Method verification took place using authorized medicinal cannabis flower samples available on the market. The substances were analysed with the help of chemical reference standards.

## INTRODUCTION

*Cannabis sativa* L. is one of the oldest agricultures and medicinal plant which produces a variety of compounds such as terpenoids, flavonoids and cannabinoids [3]. The interaction of cannabinoids with the body's own cannabinoid receptors, which occur in a variety of brain cells for coordination, memory processing and spatial orientation, opens up new pharmacological and psychological treatment options [4]. Probably the most psychoactive cannabinoid of the four different isomers of  $\Delta^9$ -THC is the (-)- $\Delta^9$ -trans-tetrahydrocannabinol, also known as dronabinol. In Germany, due to its psychoactive properties,  $\Delta^9$ -THC is controlled by the narcotics law (from the German Betäubungsmittelschutzgesetz (BtMG)). In

March 2017, the regulations changed by the amendment of article 1 BtMG. The amendment of annexes II and III of the

BtMG now allows cannabis such as marijuana plants and plant parts to be marketed and prescribed and are therefore authorised for medical purposes as ready-to-use medicinal products [1]. As cannabis is an approved medicine, production must be conducted and monitored in accordance with Good Manufacturing Practice (GMP) guidelines. In order to confirm this quality and to guarantee accurate labelling of medicinal products, food and cosmetics, the demand for standardized methods for the quantitative and qualitative determination of the ingredients especially the cannabinoids is increasing [6]. The quality assurance of the plants may be ensured by employing the German Pharmacopeia method DAB [1,5]. In this work, the HPLC method for cannabis flowers according to the DAB monography including robustness evaluation was carried out with the AZURA HPLC plus system.



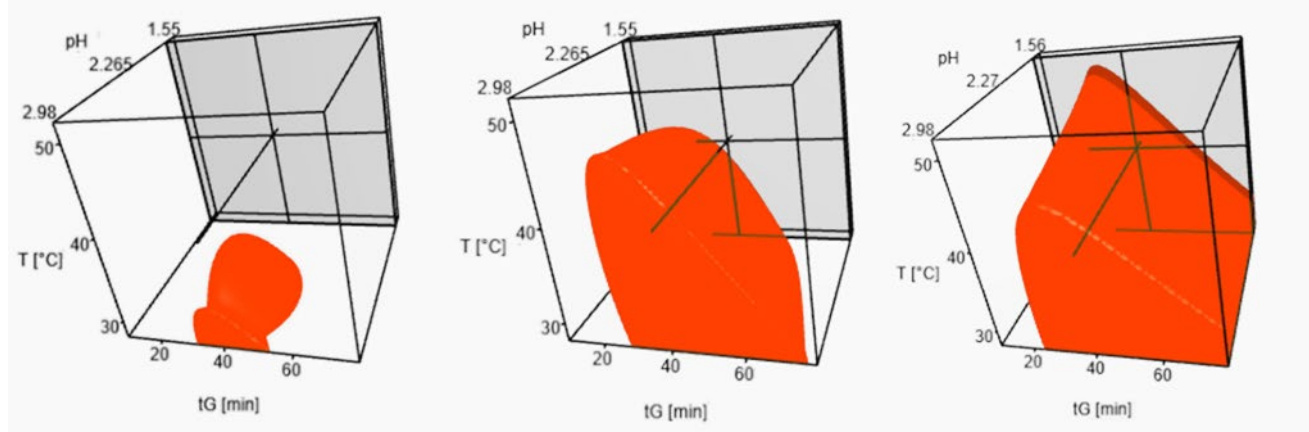
Additional Information

# Analyzing cannabis flowers according to the German Pharmacopeia

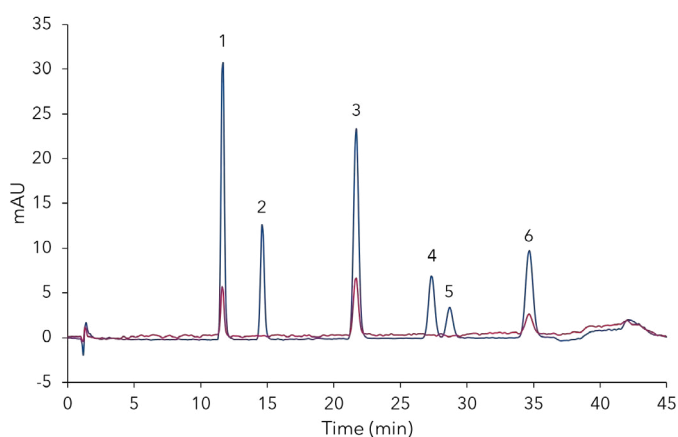
## RESULTS

A combined mobile and stationary phase design of experiment (DoE) approach with the aid of the HPLC modelling software DryLab (Molnár-Institute, Berlin, Germany) was employed. Investigated parameters were gradient time (tG), temperature (T), pH and the stationary phase of the column, producing the three dimensional spaces shown in Fig 1. The red areas in Fig 1 display the robust space of each column (critical resolution > 1.6), from which it is easily seen that the largest area is represented by the column C18P on the right. Due to the completely filled pH dimension,

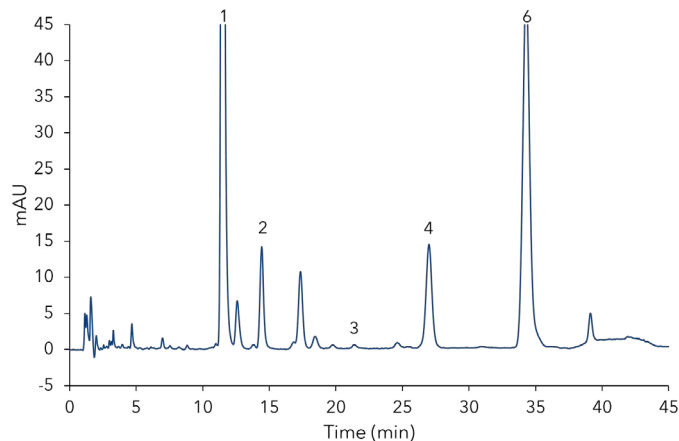
within a given temperature and gradient time, the column C18P shows a nearly unaffected pH stability for this method. Therefore, the column C18P was determined to be most robust and was therefore used for the further measurements. For the assignment of the analytes the resulting chromatogram of a standard mix from the six different cannabinoids with the concentration of 10 µg/mL is shown in Fig 2. The measurement of the cannabis flower bediol (Bedrocan, Veendam, Netherlands) with a dilution of 1 to 10 with ethanol is shown in Fig 3.



**Fig. 1** Representation of the robust space using the tG-T-pH (30/90 min, 30/50°C, pH 1.6/2.2/2.8) with the columns C18 (left), C18H (center) and C18P (right), adjusted robust space level 1.6



**Fig. 2** Chromatogram of standard mix 10 µg/mL, R=1.5 between  $\Delta^8$ -THC and  $\Delta^9$ -THC; blue - 225 nm, red - 306 nm, 1 - CBDA, 2 - CBD, 3 - CBN, 4 -  $\Delta^9$ -THC, 5 -  $\Delta^8$ -THC, 6 -  $\Delta^9$ -THCA



**Fig. 3** Chromatogram of bediol sample 1 mg/mL in ethanol; 1 - CBDA, 2 - CBD, 3 - CBN, 4 -  $\Delta^9$ -THC, 5 -  $\Delta^9$ -THCA

## SAMPLE PREPARATION

The whole 5 g portion of bediol was grinded with a flower grinder. The difference between grinded and original bediol is shown in Figure 5. The sample preparation was performed according to DAB, where 500 mg substance was extracted three times with 15 mL ethanol on a laboratory shaker for 15 min with a following centrifugation at 5000 rpm for one minute. Mixing all the extracts within 50 mL measuring flask, a 1:10 dilution was carried out and measured with the HPLC system after filtrating over a 0.45  $\mu\text{m}$  RC filter.



Fig.4 Bediol sample (left original, right grinded)

## CONCLUSION

A design of experiment combined with a column screening can be a helpful tool to determine the robustness of a method. With the help of the HPLC Modelling Software Drylab this could be tested within the three different columns with convincing results. The measured chromatograms show a sufficient separation of the six given cannabinoids according to DAB method. The specification of the DAB with a critical resolution of  $R > 1.2$  for the critical analyte pair  $\Delta^8$ -THC and  $\Delta^9$ -THC is confirmed with  $R = 1.5$  within the measurements. The sample measurement of bediol shows a sufficient assignment of the signals whereas the not identified signals can be assumed as matrix or not categorized cannabinoids. Additionally, the use of two different wavelengths shows a differentiation between the acid and neutral forms of the given cannabinoids. CBN also shows an absorption towards 306 nm due to the increased amount of conjugated systems compared to  $\Delta^8$ -THC and  $\Delta^9$ -THC.

## REFERENCES

- [8] Gesetz über den Verkehr mit Betäubungsmitteln „Betäubungsmittelgesetz in der Fassung der Bekanntmachung vom 1. März 1994 (BGBl. I S.358), das zuletzt durch Artikel 1 der Verordnung vom 2. Juli 2018 (BGBl. I S.1078) geändert worden ist“. BtMG 1981
- [9] Avoxa - Mediengruppe Deutscher Apotheker. Deutsches Arzneibuch 2017. Allgemeiner Teil, Monographien A-Z, Sachregister; Deutscher Apotheker Verlag, 2018
- [10] Hoch, E.; Friemel, C.M.; Schneider, M. Cannabis. Eine Wissenschaftliche Bestandsaufnahme; Springer: Berlin, Heidelberg, 2018
- [11] Grotenhermen, F. Endogene Cannabinoide und das Endocannabinoidsystem. In Handbuch Psychoaktive Substanzen; Heyden, M. von Jungaberle, H., Majic, T., Eds.; Springer Berlin, Heidelberg: Berlin, Heidelberg, 2018; pp. 411-420
- [12] Guideline on Good Agricultural and Collection Practice (GACP) for starting Materials of Herbal Origin. EMEA/HMPFC/2468167/2005, 2006
- [13] B.C. Smith. Inter-Lab Variation in the Cannabis Industry, Part I: Problem and Causes. Cannabis Science and Technology 2019, Vol 2 No 2

## MATERIALS AND METHODS

**Tab. 1** Standard solutions, structures and samples

Analyte	CAS	Purity/ concentration	Manufacturer
Cannabidiol (CBD)	13956-29-1	1.0 mg/mL in MeOH	Cerilliant
Cannabidiolic acid (CBDA)	1244-58-2	99.1% (HPLC)	Sigma- Aldrich
Cannabinol (CBN)	521-35-7	1.0 mg/mL in MeOH	Cerilliant
$\Delta^8$ -Tetrahydrocannabinol ( $\Delta^8$ -THC)	5957-75-5	1.0 mg/mL in MeOH	Cerilliant
$\Delta^9$ -Tetrahydrocannabinol ( $\Delta^9$ -THC)	1972-08-3	1.001 mg/mL in MeOH	Cerilliant
$\Delta^9$ -Tetrahydrocannabinolic acid ( $\Delta^9$ -THCA)	23978-85-0	98.8% (HPLC)	Sigma- Aldrich
Acetonitril	75-05-8	Gradient grade	Merck Millipore
Ethanol	64-17-5	Gradient grade	Merck Millipore
H <sub>3</sub> PO <sub>4</sub>	7664-38-2	AnalaR 85 %	VWR Chemicals

**Tab. 4** System configuration

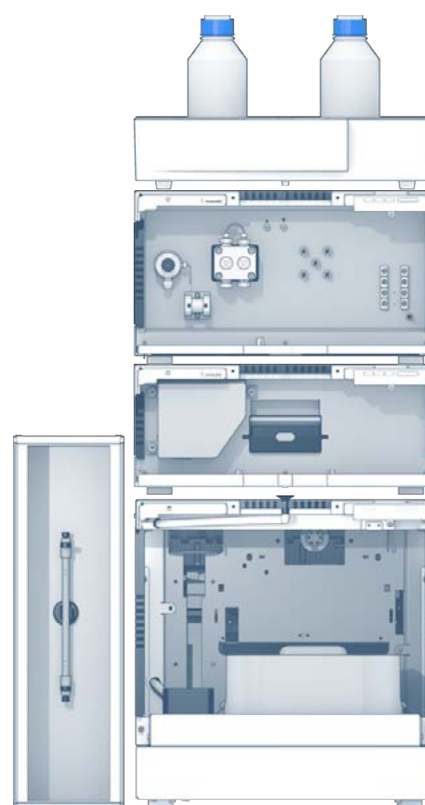
Instrument	Description	Article no.
Pump	AZURA P 6.1L, LPG	<a href="#">APH34EA</a>
Detector	AZURA MWD 2.1L	<a href="#">ADB01</a>
Flow Cell	10 mm, 10 $\mu$ L, Pressure Proof	<a href="#">AMC38</a>
Autosampler	AZURA AS 6.1L	<a href="#">AAA00AA</a>
Column thermostat	CT 2.1	<a href="#">A05852</a>
Column	Eurospher II 100-3 C18 P, Säule 150 x 4.6 mm	<a href="#">15VE182E2G</a>
	Eurospher II 100-3 C18 H, Säule 150 x 4.6 mm	<a href="#">15VE185E2G</a>
	Eurospher II 100-3 C18, Säule 150 x 4.6 mm	<a href="#">15VE181E2G</a>
Software	Clarity Chrom 8.1	<a href="#">A1670</a>
HPLC modelling software	DryLab 4.3.4.2	-

**Tab. 2** Method parameters

Column temperature	40°C
Injection volumen	10 $\mu$ L
Injection mode	Full loop
Detection	UV 225 nm /306 nm
Data rate	10 Hz

**Tab. 3** Pump parameters

Eluent A	Water, HPLC grade (H <sub>3</sub> PO <sub>4</sub> 85% 8.64 g/L)		
Eluent B	Acetonitrile, gradient grade		
Flow rate	1.0 mL/min		
Pump program	Time (min)	% A	% B
	0	35	65
	35	30	70
	37	20	80
	40	20	80
	42	35	65
	45	35	65





## (C)an(n)alyze: determination of 16 cannabinoids inside flowers, oils and seeds

Lisa Loxterkamp, Svea Stephan, Kate Monks; applications@knauer.net  
KNAUER Wissenschaftliche Geräte GmbH, Hegauer Weg 38, 14163 Berlin; www.knauer.net.



### SUMMARY

Research within cannabinoids for pharmaceutical purposes increases, likewise does the number of substances to be tested. Therefore, compared to the German pharmacopoeia (Deutsches Arzneibuch; DAB), an increase of 10 cannabinoids was performed for qualification and quantification with this work. The aim of the method development was to decrease the runtime and optimize the gradient program in comparison to the DAB method<sup>1</sup>. To ensure accuracy of the method, a validation was performed according to ICH Guidelines Q2 R1<sup>2</sup>. Parameters for the validation were selectivity, linearity, repeatability and the recovery rate. The given specification was derived from the Association of Official Analytical Chemists (AOAC) with the given standard method performance requirements for cannabis flowers and oils<sup>3</sup>.

### INTRODUCTION

*Cannabis sativa L.* is one of the oldest agricultural and medicinal plants, which produces a variety of compounds such as terpenoids, flavonoids and cannabinoids<sup>4</sup>. The interaction of cannabinoids with the body's own cannabinoid receptors, which occur in a variety of brain cells for coordination, memory processing and spatial orientation, enables new pharmacological and psychological treatment options<sup>5</sup>. Probably the most psychoactive cannabinoid of the 4 different isomers of  $\Delta^9$ -THC is the (-)- $\Delta^9$ -*trans*-tetrahydrocannabinol, also known as dronabinol (Fig. 1). In Germany  $\Delta^9$ -THC is controlled by the narcotics law (Betäubungsmittelschutzgesetz; BtMG) due to its psychoactive properties. Since March 2017 the regulations changed by the amendment of article 1 BtMG. The amendment of annexes II and III of the BtMG now allows cannabis such as marijuana

plants and plant parts to be marketed and prescribed. Thereby, cannabis was authorised for medical purposes as ready-to-use medicinal products<sup>6</sup>. Production of cannabis products must be conducted and monitored in accordance with good manufacturing practice guidelines (GMP) to guarantee accurate labelling of medicinal products, food and cosmetics.

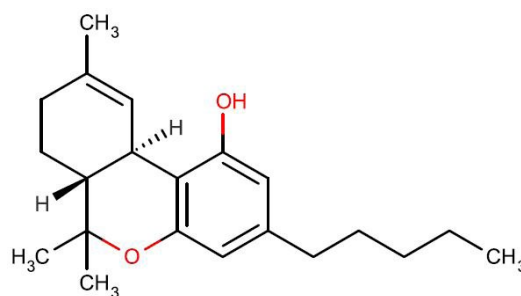


Fig. 1 Structure of (-)- $\Delta^9$ -*trans*-tetrahydrocannabinol.



Additional Information

# (C)an(n)alyze: determination of 16 cannabinoids inside flowers, oils and seeds

## INTRODUCTION

Therefore, the demand for standardized methods for the quantitative and qualitative determination of the ingredients especially the cannabinoids is increasing<sup>7</sup>. In this work an HPLC method development for the qualification and quantification of 16 different cannabinoids

## RESULTS

As shown in previous work, the column Eurospher II C18P 100-3, 100 x 4.6 mm was determined as the most robust one while separating 6 different cannabinoids<sup>7</sup>. Therefore, the development was carried out with a C18P phase. The final method was selected to provide the best compromise of a simple method with short runtime and high resolution (Tab. 5). During the method development, the aqueous eluent was acidified once with phosphoric acid and once with formic acid to pH 2.2 with the result of no difference in elution behavior. In all following chromatograms 2 different absorption lines were monitored. While the blue line is detected at 228 nm, the red one is detected at 306 nm. Due to the various absorption behavior of each cannabinoid, a differentiation between the neutral and acid forms can be concluded. The resulting chromatogram with a 5 µg/mL standard mix is shown in Fig. 2.

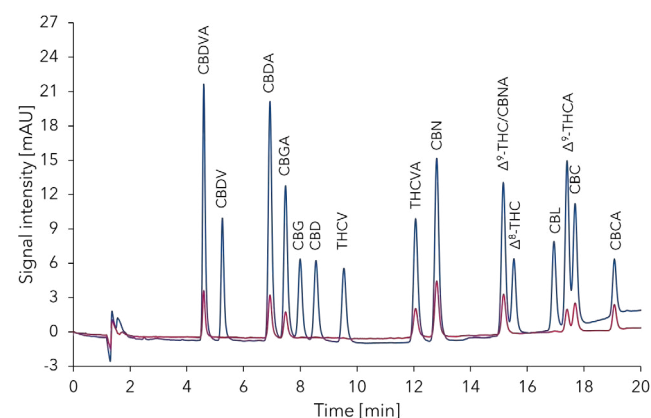


Fig. 2 Reference standard mixture of 16 cannabinoids with a concentration of 5.00 µg/mL (blue: 228 nm; red: 306 nm).

inside the matrices flowers, oils and seeds was carried out with the KNAUER AZURA® HPLC system. In order to check the performance of the method, a validation according to the ICH Guidelines Q2 R1 was carried out<sup>2</sup>. The tested cannabinoids are described in Tab. 1.

To confirm the selectivity within the given matrices flower, oil and hemp seeds, 3 different samples were measured during the method development and before validation. The chromatograms are shown in Fig. 3 to Fig. 5.

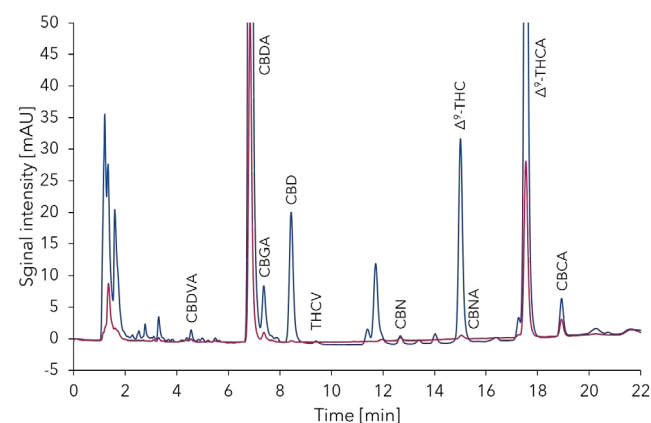


Fig. 3 Bedioli sample preparation according to Mudge et al. 2017, 0.84 mg flower/mL methanol (blue: 228 nm; red: 306 nm)<sup>9</sup>.

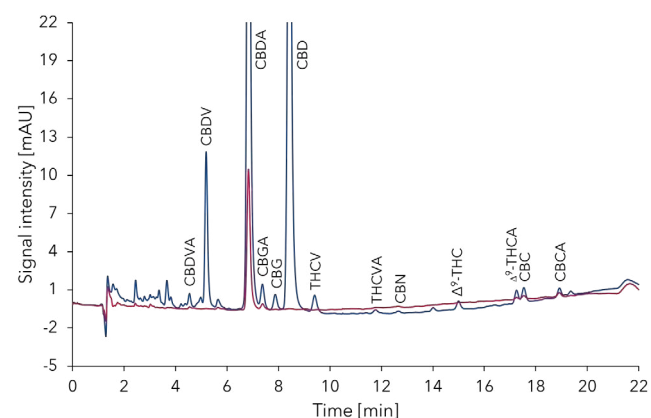
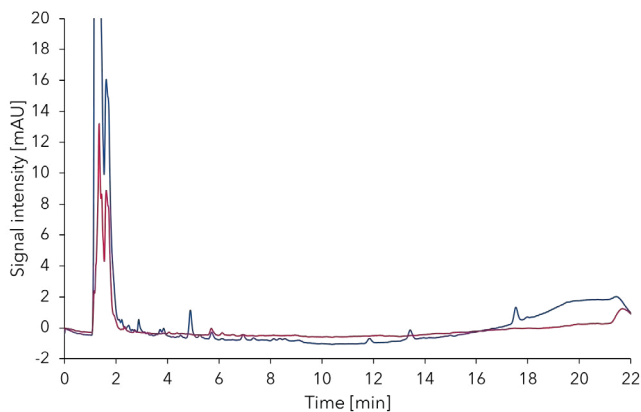


Fig. 4 CBD oil sample preparation according to Mudge et al. 2017, 0.62 mg oil/mL methanol (blue: 228 nm; red: 306 nm)<sup>9</sup>.

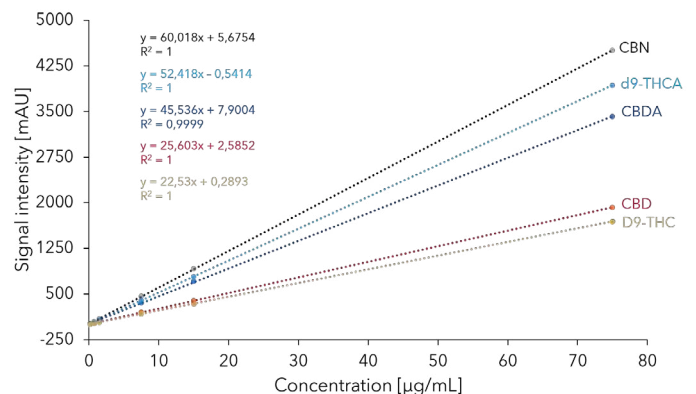
## RESULTS



**Fig. 5** Hemp seed sample preparation according to Mudge et al. 2017, 22 mg seeds/mL methanol (blue: 228 nm; red: 306 nm)<sup>9</sup>.

Up to 11 cannabinoids were found in the cannabis sample bediol and 6 of them were within the calibration range of 0.15 - 75.00 µg/mL. 8 out of 13 cannabinoids could be quantified within the oil matrix. As previously suspected the matrix „hemp seed“ showed no cannabinoids within the calibration range. In all cases the quantification of  $\Delta^9$ -THC is only possible in the absence of CBNA. This is confirmed by the absorption at 306 nm. Since CBNA is a degradation product of  $\Delta^9$ -THCA, it only occurs in products that have been stored for a longer time. During this validation CBNA was only found in a trace amount in bediol. This amount correlates with the high amount of  $\Delta^9$ -THCA inside the bediol sample as well as the long storage since the harvest in April 2018. The following results were produced within the validation. During the calibration it was figured out that linearity was given between the concentration of 0.15 - 75.00 µg/mL. All calibration curves in the range of 0.15 - 75.00 µg/mL were passing the variance homogeneity as well as the linearity after the mathematical equation of Mandel. The resulting coefficients were all

above  $R > 0.999$  for every cannabinoid. The calibration curves are shown respectively for the cannabinoids CBD, CBDA, CBN,  $\Delta^9$ -THC and  $\Delta^9$ -THCA in **Fig. 6**.



**Fig. 6** Calibration curves and linearity for the cannabinoids CBD, CBDA, CBN,  $\Delta^9$ -THC and  $\Delta^9$ -THCA at 228 and 306 nm.

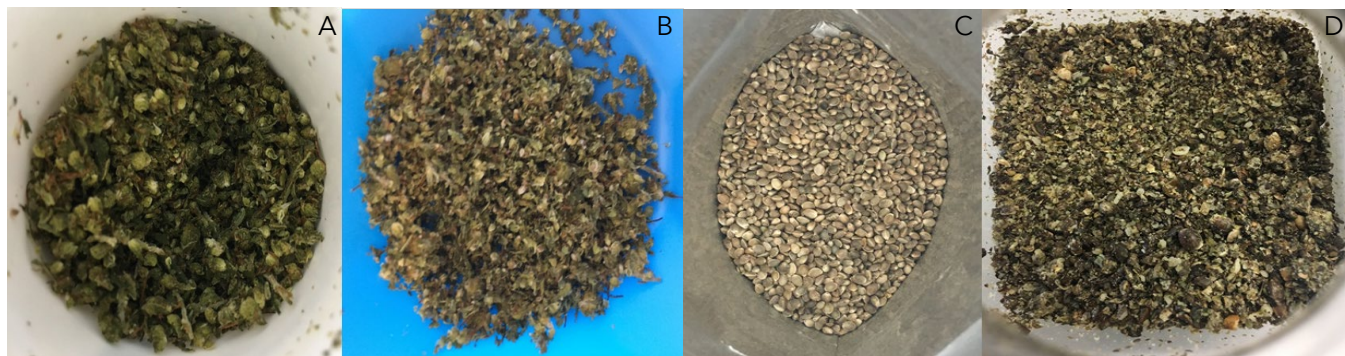
The repeatability was measured with a six-time repetition of different concentrations inside the CBD oil. This was made to ensure reproducibility over the entire calibration range. The area ratios of the different dilutions range from 0.6 - 5200 mAU\*s. The results of the repeatability shown in **Tab. 2** are all below 1 % relative standard deviation (RSD) and thereby within the lowest limit of  $RSD < 2\%$  by the AOAC<sup>3</sup>. Even CBN with an area of 0.6 mAU shows an RSD of under 2 % and is therefore within the limits. CBL, CBNA and  $\Delta^8$ -THC could not be detected inside the CBD oil, so the verification was made over a six-time repetition within the recovery rate. The recovery rate was evaluated within 2 different concentration levels close to the lowest calibration value. A blank sample was spiked with 50 µL/100 µL of each cannabinoid standard (0.1 mg/mL) filled up with 25 mL solvent and was prepared 3 times according to Mudge et al. 2017<sup>9</sup>. For both quantified levels (0.20 and 0.40 µg/mL) the recovery rates were in between the specification range of the AOAC from 95 - 105 %. The results are shown in **Tab. 3**.

# (C)an(n)alyze: determination of 16 cannabinoids inside flowers, oils and seeds

## SAMPLE PREPARATIONS

5 g of bediol were grinded with a flower grinder. The hemp seed was grinded with a kitchen mixer, after a mechanical pretreatment to open the seeds. The difference between grinded and original bediol and hemp seeds is shown in **Fig. 7**. The sample preparation was performed according to Mudge et al. 2017,

where 200 mg flowers/seeds were extracted with 25 mL 80 % methanol or 50 mg oil were extracted with 10 mL methanol for 15 min inside an ultra-sonic bath, with every 5 min shaking onto a vortex device<sup>9</sup>. After filtrating over a 0.20 µm PTFE syringe filter the solution was measured with the HPLC system.



**Fig. 7** Bediol sample: original (A) and grinded (B). Hemp seeds: original (C) and grinded (D).

## CONCLUSION

Compared to the given pharmacopoeia from 2017 a 20 min shorter method with a less acidic eluent was developed<sup>1</sup>. The separation of all 16 cannabinoids was achieved with a sufficient resolution in both, the standard mixture and the 3 different sample matrices. The developed method is suitable for the qualification and quantification of 15 cannabinoids in the absence of CBNA. The validation was performed according to the given ICH Q2 R1 guideline with standard method performance requirements of the AOAC. In accordance with the prescribed laws for hemp cultivation, the lowest calibration point of 0.15 µg/mL (0.02 %) falls below the maximum specification content of 0.2 %  $\Delta^9$ -THC by one order of magnitude. Additionally, in all cases the correlation coefficient of the linearity was over  $R > 0.999$ . The recovery rate and the repeatability were inside the performance requirements of the AOAC.

*KNAUER does not endorse the use of its products in connection with the illegal use, cultivation or trade of cannabis products. KNAUER does not endorse the illicit use of marijuana, we merely provide an overview of the methods and systems of cannabis analysis.*

## MATERIALS AND METHODS

Tab. 1 Standard solutions and samples

Analyte	CAS	Purity / Concentration
Cannabichromene (CBC)	20675-51-8	0,972 mg/mL (MeOH)
Cannabichromene acid (CBCA)	185505-15-1	0,999 mg/mL (ACN)
Cannabidivarin (CBDV)	24274-48-4	0,986 mg/mL (MeOH)
Cannabidivarinic acid (CBDVA)	31932-13-5	1,009 mg/mL (ACN)
Cannabidiol (CBD)	13956-29-1	1,000 mg/mL (MeOH)
Cannabidiolic acid (CBDA)	1244-58-2	1,000 mg/mL (ACN)
Cannabigerol (CBG)	25654-31-3	0,995 mg/mL (MeOH)
Cannabigerolic acid (CBGA)	25555-57-1	0,991 mg/mL (ACN)
Cannabinol (CBN)	521-35-7	1,000 mg/mL (MeOH)
Cannabinol acid (CBNA)	2808-39-1	0,986 mg/mL (ACN)
Cannabicyclol (CBL)	21366-63-2	0,992 mg/mL (ACN)
$\Delta^8$ -Tetrahydrocannabinol ( $\Delta^8$ -THC)	5957-75-5	1,000 mg/mL (MeOH)
$\Delta^9$ -Tetrahydrocannabinol ( $\Delta^9$ -THC)	1972-08-3	1,001 mg/mL (MeOH)
$\Delta^9$ -Tetrahydrocannabinolic acid ( $\Delta^9$ -THCA)	23978-85-0	1,000 mg/mL (ACN)
$\Delta^9$ -Tetrahydrocannabivarin (THCV)	28172-17-0	0,991 mg/mL (MeOH)
$\Delta^9$ -Tetrahydrocannabivarinic acid (THCVA)	39986-26-0	1,015 mg/mL (ACN)

Solvent	CAS	Purity / Concentration
Acetonitril	75-05-8	Gradient grade
Formic acid	64-18-6	99 %
H <sub>3</sub> PO <sub>4</sub>	7664-38-2	AnalaR 85 % NORMAPUR
Methanol	67-56-1	Gradient grade

Sample	Manufacturer	Batch
CBD oil (hemp seed)	Pharma Hemp (Slovenia)	DR05018142B
Hemp seeds	VEGJi (Germany)	
Bediol flower	Bedrocan (Netherlands)	18D13FB19A23

# (C)an(n)alyze: determination of 16 cannabinoids inside flowers, oils and seeds

## MATERIALS AND METHODS

**Tab.2** Repeatability of all cannabinoids

Analyte	Repeatability [%]			Recovery rate 0.40 µg/mL	Recovery rate 0.20 µg/mL
	6.2 mg oil/mL solvent	0.62 mg oil/mL solvent	0.31 mg oil/mL solvent		
CBC	0.71	0.79	0.65	-	-
CBCA	0.65	0.88	0.89	-	-
CBD	0.19	0.21	0.46	-	-
CBDA	0.18	0.16	0.34	-	-
CBDV	0.21	0.40	0.61	-	-
CBDVA	0.54	0.65	0.66	-	-
CBG	0.37	0.77	0.89	-	-
CBGA	0.30	0.65	0.83	-	-
CBL	-	-	-	0.95	0.82
CBN	0.41	1.49	1.25	-	-
CBNA	-	-	-	0.88	0.84
Δ <sup>8</sup> -THC	-	-	-	0.95	0.85
Δ <sup>9</sup> -THC	0.56	0.70	0.90	-	-
Δ <sup>9</sup> -THCA	0.55	0.51	0.58	-	-
Δ <sup>9</sup> -THCV	0.21	0.87	0.68	-	-
Δ <sup>9</sup> -THCVA	0.44	0.66	0.86	-	-

**Tab.3** Recovery rate of all cannabinoids

Analyte	Recovery rate [%]	
	0.20 µg/mL	0.40 µg/mL
CBC	96.36	98.45
CBCA	95.07	103.43
CBD	102.19	98.80
CBDA	98.33	100.65
CBDV	100.11	102.49
CBDVA	100.65	100.70
CBG	103.55	95.66
CBGA	98.54	101.46
CBL	101.27	104.70
CBN	102.83	104.97
Δ <sup>8</sup> -THC	101.94	95.02
Δ <sup>9</sup> -THCA	96.50	98.33
Δ <sup>9</sup> -THCV	100.75	97.34
Δ <sup>9</sup> -THCVA	102.60	95.68

## MATERIALS AND METHODS

**Tab. 4** Method

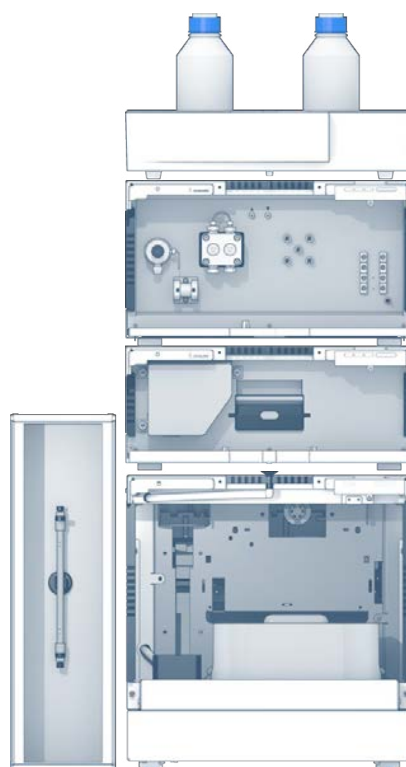
Column temperature	25 °C
Injection volume	10 µL
Injection mode	Partial loop
Detection	UV 228 nm, 306 nm
Data rate	10 Hz

**Tab. 5** Gradient

Eluent (A)	Water, HPLC grade, pH 2.2 with 85 % H <sub>3</sub> PO <sub>4</sub>		
Eluent (B)	Acetonitrile, gradient grade		
Flow rate	1.0 mL/min		
	<b>Time [min]</b>	<b>(A) %</b>	<b>(B) %</b>
Pump program	0	25	75
	7	25	75
	17	10	90
	19	10	90
	20	25	75
	22	25	75

**Tab. 6** System configuration

Instrument	Description	Article No.
Pump	AZURA P 6.1 L LPG	<a href="#">APH34EA</a>
DAD detector	AZURA MWD 2.1 L	<a href="#">ADB01</a>
Flow cell	10 mm, 10 µL, PressureProof	<a href="#">AMC38</a>
Autosampler	AZURA AS 6.1 L	<a href="#">AAA00AA</a>
Column thermostat	AZURA CT 2.1	<a href="#">A05852</a>
Column	Eurospher II 100-3 C18P, 150 x 4.6 mm	<a href="#">15VE182E2G</a>
Software	ClarityChrom 8.1	<a href="#">A1670</a>



## REFERENCES

- [14] Deutsches Arzneibuch 2017 (DAB). Allgemeiner Teil. Deutscher Apotheker Verlag (2018).
- [15] The International Council of Harmonisation of Technical Requirements for the Registration of Pharmaceuticals for Human Use (ICH) Validation of analytical procedures: text and methodology, Q2(R1). CPMP/ICH/381/95 (1995).
- [16] Association of Official Analytical Chemists (AOAC). New SPSFAM Draft Standard Method Performance Requirements (SMPR): Cannabis 2 SMPRs (2016).
- [17] Hoch, E., Friemel, C. M., Schneider, M. Cannabis. Eine Wissenschaftliche Bestandsaufnahme. Springer: Berlin, Heidelberg (2018).
- [18] Grotenhermen, F. Endogene Cannabinoide und das Endocannabinoidsystem. In: Handbuch Psychoaktive Substanzen. von Heyden, M., Jungaberle, H., Majic, T. Springer: Berlin, Heidelberg (2018).
- [19] Gesetz über den Verkehr mit Betäubungsmitteln „Betäubungsmittelgesetz in der Fassung der Bekanntmachung vom 1. März 1994 (BGBl. I S.358), das zuletzt durch Artikel 1 der Verordnung vom 2. Juli 2018 (BGBl. I S.1078) geändert worden ist“. BtMG (1981).
- [20] Loxterkamp, L., Monks, K. Analyzing cannabis flowers according to the German Pharmacopeia. KNAUER Wissenschaftliche Geräte GmbH (2019).
- [21] Smith, B. C. Inter-lab variation in the cannabis industry. Part I: Problem and causes. Cannabis Science and Technology 2 (2), (2019).
- [22] Mudge, E. M., Murch, S. J., Brown, P. N. Leaner and greener analysis of cannabinoids. Analytical and Bioanalytical Chemistry 409 (12), 3153-3163 (2017).

## RELATED KNAUER APPLICATIONS

[VPH0069](#) - Analyzing cannabis flowers according to the German Pharmacopeia - monograph 2017

[VPH0072](#) - Analyzing cannabis flowers according to the German Pharmacopeia - monograph 2018



# Purification of chamazulene by preparative HPLC and its scale-up

Yannick Krauke, Kate Monks; [applications@knauer.net](mailto:applications@knauer.net)

KNAUER Wissenschaftliche Geräte GmbH, Hegauer Weg 38, 14163 Berlin  
[www.knauer.net](http://www.knauer.net)



## SUMMARY

Extraction of natural components from plants that are used for medical treatments is widely applied. Often the extraction process results in an oil, such as the chamomile blue oil with many different compounds. Usually only some of these components are responsible for the medical properties of the whole extract. In chamomile oil, chamazulene is one of these medical active compounds. Here, the preparative purification of chamazulene by HPLC from chamomile blue oil is described.

## INTRODUCTION

Chamomile plants are known for their medical properties, featuring anti-inflammatory, analgesic and sedative effects. These result from the various phenolic compounds found in the flowers. One of those compounds is matricin, which is converted to chamazulene during the distillation process<sup>1,2</sup>. Chamazulene gives the chamomile oil, also known as "chamomile blue", its characteristic blue colour. It was shown that chamazulene alone has anti-inflammatory and

antioxidant activity<sup>3</sup>. Different HPLC methods are established to analyze chamomile samples from different sources. Various extraction and distillation processes are described. But so far, no published preparative HPLC method for purification of chamazulene is available<sup>2</sup>. The present application uses preparative HPLC to purify pure chamazulene from commercially available "chamomile blue" oil.

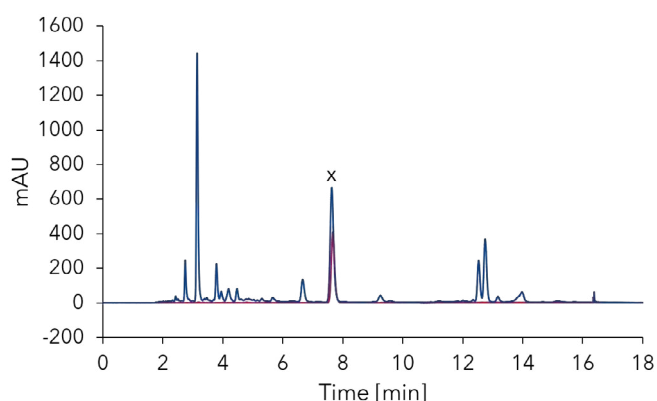


# Purification of chamazulene by preparative HPLC and its scale-up

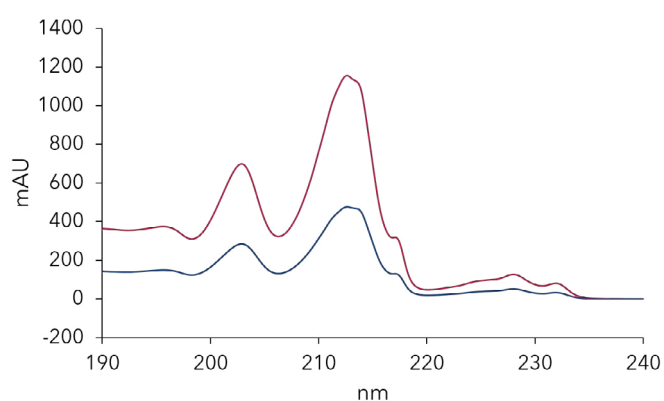
## RESULTS

The chamomile blue oil was diluted in methanol and water (90:10; v/v). The insoluble components were removed by filtration. The comparison of the oil sample and the chamazulene standard chromatograms revealed the chamazulene peak at a retention time of 7.6 min (**Fig. 1**). The spectra from 190 to 400 nm of the chamomile oil sample and the standard proved that the identified peak at 7.6 min is chamazulene (**Fig. 2**). The profiles of both spectra are nearly identical. The applied analytical method showed a baseline separation of the chamazulene peak from the nearest earlier and later eluting peaks (**Fig. 1**). Therefore, the method was directly transferred to a semi-preparative scale. A column with the same length but larger inner diameter (4.6 to 20 mm ID), larger particles (5 to 10  $\mu\text{m}$ ) and an increased flow rate of 25 mL/min was used. Different sample volumes were injected. The results revealed that 1 mL sample load lead to a good separation of the chamazulene from other components in the sample (**Fig. 3**). For the final purification 2 mL of sample were injected and the chamazulene

peak was collected using a fractionation valve (**Fig. 4**). The fraction was analysed with the analytical method and compared to the chamazulene standard. The result showed that the fractionation was successful as only the peak of chamazulene was detected (**Fig. 5**). Quantification of chamazulene in the fraction of the 2 mL injection revealed a 100 % recovery of the chamazulene from the sample. The dilution was approximately 1:10 (**Tab. 1**). As the purification was successful in the semi-preparative scale, the method was further scaled-up to a column with 50 mm ID. The column length was shortened from 250 to 150 mm to reduce solvent consumption and fasten the method. The method was adapted, increasing the flow rate to 150 mL/min and the injection volume to 10 mL (**Fig. 6**). Analysis of the fraction and comparison with the chamazulene standard revealed that the fraction contained chamazulene without any other detectable impurities (**Fig. 7**). The recovery of chamazulene was 82 % in the fraction of the 10 mL injection (**Tab. 1**).

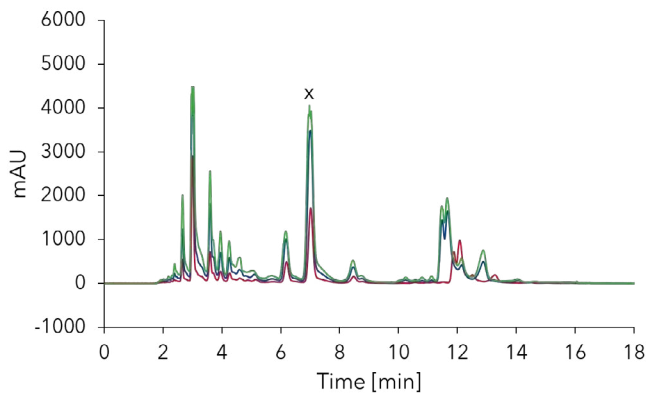


**Fig. 1** Overlay chromatograms of chamazulene standard (red) and chamomile blue oil sample (blue). x - chamazulene peak; standard: 0.75 mg/mL, 1  $\mu\text{L}$  injection; sample: 1:10 dilution, 1  $\mu\text{L}$  injection; 1.3 mL/min.

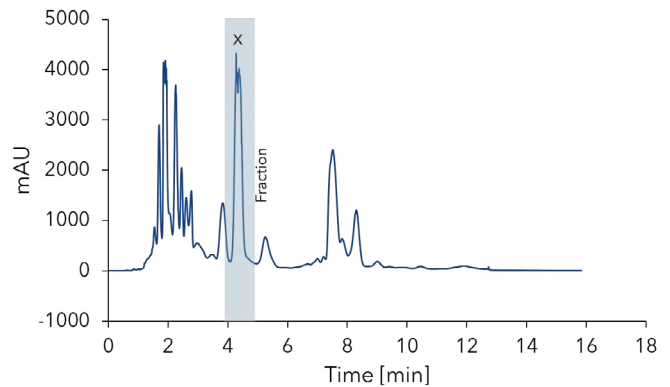


**Fig. 2** Spectrum chamazulene standard (red) and chamomile oil sample (blue) at 7.6 min.

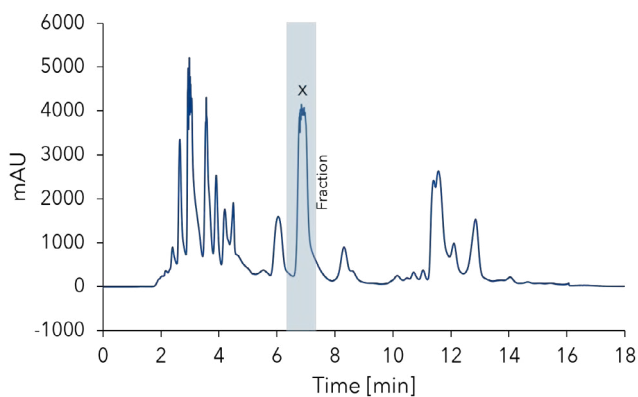
## RESULTS



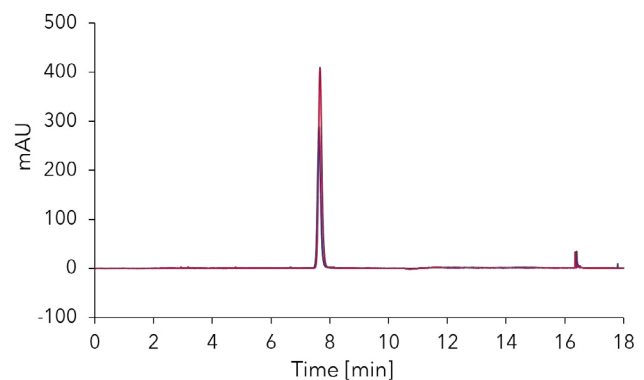
**Fig. 3** Overload study. Chromatograms of different injection volumes on semi-preparative column: red 200 µL, blue 500 µL, green 1000 µL. x - chamazulene peak; chamomile oil 1:10 dilution; C18 20 x 250 mm, 10 µm, 25 mL/min.



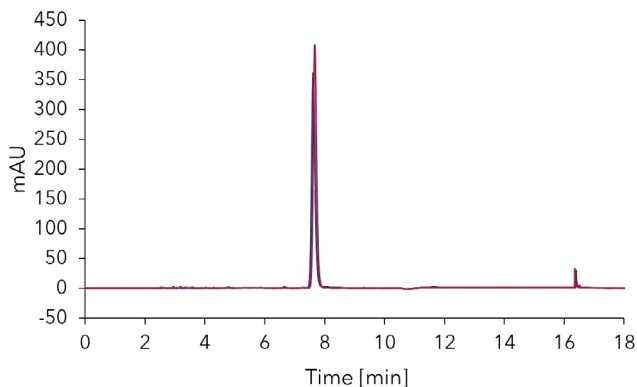
**Fig. 6** Chromatogram chamazulene purification. Collected fraction highlighted in grey. 10 mL injection volume; x - chamazulene peak; C18 50 x 150 mm; 10 µm; 150 mL/min.



**Fig. 4** Chromatogram chamazulene purification. Collected fraction highlighted in grey. 2 mL injection volume; x - chamazulene peak; C18 20 x 250 mm; 10 µm; 25 mL/min.



**Fig. 7** Overlay fraction from Fig. 6 and chamazulene standard (0.75 mg/mL) on analytical column.



**Fig. 5** Overlay fraction from Fig. 4 in blue and chamazulene standard (0.75 mg/mL) in red on analytical column.

**Tab. 1** Quantification of chamazulene concentration in the fractions of 2 and 10 mL injection from purification

	2 mL injection	10 mL injection
Chamazulene concentration sample [mg/mL]	1,240	1,048
Total amount chamazulene injected [mg]	2,48	10,48
Chamazulene concentration fraction [mg/mL]	0,133	0,101
Fraction volume [mL]	19	85
Total amount chamazulene in fraction [mg/mL]	2,526	8,619
Recovery [%]	101,80	82,20

# Purification of chamazulene by preparative HPLC and its scale-up

## SAMPLE PREPARATIONS

The chamazulene standard (Sigma Aldrich) was dissolved in methanol to desired concentrations for calibration curve and filtered (0.45  $\mu\text{m}$ ). A 5-point calibration curve was calculated with following concentrations in triplicates: 0.015, 0.150, 0.375, 0.750 and 1.500 mg/mL chamazulene. Blue chamomile essential oil

“Kamillen Öl Blau” was purchased by manufacturer/distributor ASAV Apoth.Serv.Arzneim.Vetr.GmbH; PZN 06984428; 2 mL. The oil was diluted in a ratio of 1:10 with methanol and water (90:10; v/v). The insoluble fraction was removed by filtration through a 0.45  $\mu\text{m}$  filter.

## CONCLUSION

A preparative reverse phase method was developed for the purification of chamazulene from chamomile blue oil sample. The chamazulene was purified in high purity (approximately 100 %) and with high recovery (> 100 %) in semi-preparative scale (20 mm ID column). The high recovery can be explained by error propagation during the measurements. The chamazulene was identified in the sample and fraction by comparing retention time and spectra with the chamazulene standard. To increase the throughput, the method was adapted to a 50 mm ID column with the same particle size as the semi-preparative column. The pump was easily upgraded to higher flow rates by replacing the 100 mL pump head with a 250 mL pump head. From the 10 mL injected sample 82 % chamazulene were recovered by fractionation. The recovery could be increased by enlarging the fraction window, but could lead to impurities in the fraction. After the development of a reverse phase method for preparative HPLC purification of chamazulene from chamomile blue oil, an alternative normal phase HPLC method could be interesting. Normal phase separations are often used in industrial scale due to better solubility for some samples and easier evaporation of the used solvents.

## MATERIALS AND METHODS

**Tab. 2** Configuration analytical system

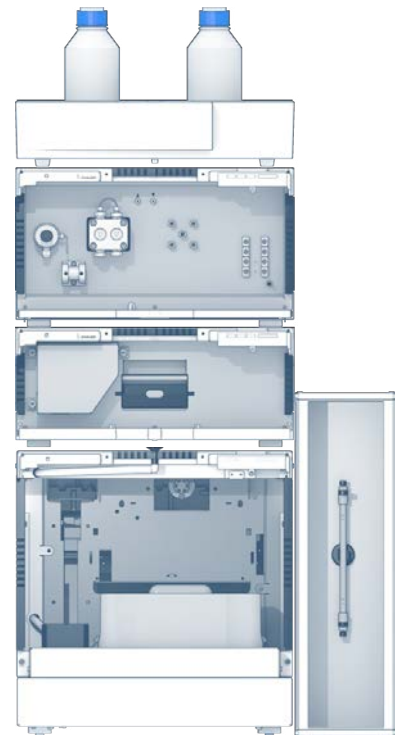
Instrument	Description	Article No.
Pump	AZURA P 6.1L LPG 10 mL/min, sst	<a href="#">APH34EA</a>
Autosampler	AZURA AS 6.1L, 700 bar	<a href="#">AAA00AA</a>
Detector	AZURA DAD2.1L	<a href="#">ADC01</a>
Flow cell	Light guide 10mm / 2 µL / 50 bar	<a href="#">AMC19XA</a>
Thermostat	AZURA CT2.1	<a href="#">A05852</a>
Column	Eurospher II 100-5 C18, 250 x 4.6 mm ID	<a href="#">25VE181E2J</a>
Software	ClarityChrom 8.1 - workstation, autosampler control included	<a href="#">A1670</a>
Software	ClarityChrom 8.1 - PDA extension	<a href="#">A1676</a>

**Tab. 3** Analytical method - pump parameters

Eluent A	H <sub>2</sub> Odd		
Eluent B	Acetonitrile		
Flow rate	1.3 mL/min		
Pump program	Time (min)	%A	%B
	0.00	10	90
	10.00	10	90
	10.02	0	100
	16.00	0	100
	16.02	10	90
	22.00	10	90

**Tab. 4** Analytical method - method parameters

Column temperature	25 °C
Injection volume	5 µL
Injection mode	Partial loop
Detection	UV 245 nm / 285 nm / 3D 190 - 400 nm
Data rate	20 Hz



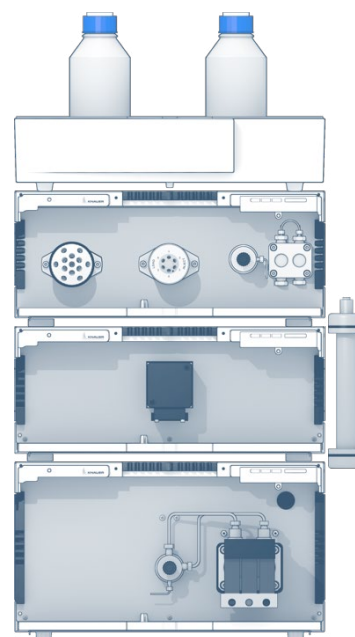
## MATERIALS AND METHODS

**Tab. 5** Configuration preparative system

Instrument	Description	Article No.
Pump	AZURA P 2.1L, 100 mL/min sst	<a href="#">APE20KA</a>
Ternary LGP module	AZURA LPG ternary module for Pump P 2.1L	<a href="#">AZZ00AB</a>
Pump head	Pump head 250 mL/min, sst	<a href="#">A4021-1</a>
Detector	UVD 2.1L	<a href="#">ADA01XA</a>
Assistant	Left: 6 Mpos, 1/8", sst Middle: 6Port2Pos, 1/16", sst Right: P4.1S, 50 mL, sst	<a href="#">AYEKEABR</a>
Flow cell	3 µL; 1/16"	<a href="#">A4069</a>
Column	Eurospher II 100-10 C18, 250 x 20 mm ID	<a href="#">25PE181E2N</a>
Column	Eurospher II 100-10 C18, 150 x 50 mm ID	<a href="#">15OE181E2N</a>
Software	PurityChrom®Basic	<a href="#">A2650</a>

**Tab. 6** Preparative methods - pump parameters

Eluent A	90:10 Acetonitrile:H <sub>2</sub> O:Odd (v/v)					
Eluent B	100 % Acetonitrile					
	ID 20 mm column			ID 50 mm column		
Flow rate	25 mL/min			150 mL/min		
Pump program	Time (min)	%A	%B	Time (min)	%A	%B
	0.00	100	0	0.00	100	0
	8.00	100	0	5.45	100	0
	8.02	0	100	5.47	0	100
	14.00	0	100	11.45	0	100
	14.02	100	0	11.47	100	0
	18.00	100	0	18.00	100	0



**Tab. 7** Preparative methods - method parameters

	ID 20 mm column	ID 50 mm column
Column temperature	ambient	ambient
Injection volume	1 mL, 2 mL	10 mL
Injection mode	Injection loop	Injection loop
Detection	UV 245 nm	UV 245 nm
Data rate	2 Hz	2 Hz

## REFERENCES

- [23] Srivastava, J. K., Gupta, S. Extraction, characterization, stability and biological activity of flavonoids isolated from chamomile flowers. *Mol Cell Pharmacol* 1(3), 138 (2009).
- [24] Hagi, G., Hatami, A., Safaei, A., Mehran, M. Analysis of phenolic compounds in *Matricaria chamomilla* and its extracts by UPLC-UV. *Res Pharm Sci* 9(1), 31-7 (2014).
- [25] Salihovic, M., Sapcanin, A., Spirtovic-Halilovic, S., Završnik, D. DFT structural analysis of chamazulene. *Bull Chem Technol Bosnia Herzegovina* 46, 27-32 (2016).

# Analyzing cannabis flowers according to the German Pharmacopeia - monograph 2018

Lisa Loxterkamp, Kate Monks; applications@knauer.net  
KNAUER Wissenschaftliche Geräte GmbH, Hegauer Weg 38, 14163 Berlin; www.knauer.net.



## SUMMARY

Since the change in German narcotics law in 2017 (§1 Abs. 1, Betäubungsmittelgesetz; BtMG) the need for reliable and robust HPLC methods for quality control has drastically increased<sup>1</sup>. Six common cannabinoids of high medicinal interest Cannabidiol (CBD), Cannabidiolic acid (CBDA), Cannabinol (CBN),  $\Delta^8$ -Tetrahydrocannabinol ( $\Delta^8$ -THC),  $\Delta^9$ -Tetrahydrocannabinol ( $\Delta^9$ -THC) and  $\Delta^9$ -Tetrahydrocannabinolic acid ( $\Delta^9$ -THCA) were quantified on the KNAUER AZURA® HPLC plus system according to the monograph of German Pharmacopeia 2018 (Deutsches Arzneibuch; DAB)<sup>2</sup>. The method was verified using an authorized medicinal cannabis flower available on the market. The assignment of the analytes was made with chemical reference standards.

## INTRODUCTION

*Cannabis sativa L.* is one of the oldest agricultural and medicinal plants which produces a variety of compounds such as terpenoids, flavonoids and cannabinoids<sup>3</sup>. The interaction of cannabinoids with the body's own cannabinoid receptors, which occur in a variety of brain cells for coordination, memory processing and spatial orientation, provides new pharmacological and psychological treatment options<sup>4</sup>. Probably the most psychoactive cannabinoid of the four different isomers of  $\Delta^9$ -THC is the (-)- $\Delta^9$ -*trans*-tetrahydrocannabinol, also known as dronabinol. In Germany,  $\Delta^9$ -THC is controlled by the narcotics law, due to its psychoactive properties. Since March 2017, the regulation has changed due to the amendment of Article 1 BtMG. The amendment of annexes II and III of the BtMG now allows the marketing and

prescription of cannabis such as marijuana plants and plant parts. Therefore they are authorised for medical purposes as ready-to-use medicinal products<sup>1</sup>. Production of cannabis products must be conducted and monitored in accordance with Good Manufacturing Practice guidelines (GMP). To guarantee accurate labelling of medicinal products, food and cosmetics, the demand for standardized methods for the quantitative and qualitative determination of ingredients is increasing, especially for cannabinoids<sup>5</sup>. The quality assurance of the plants may be ensured by employing the German Pharmacopeia method DAB<sup>2</sup>. In this work, the HPLC method for cannabis flowers according to the DAB monograph was carried out with the KNAUER AZURA® HPLC plus system.



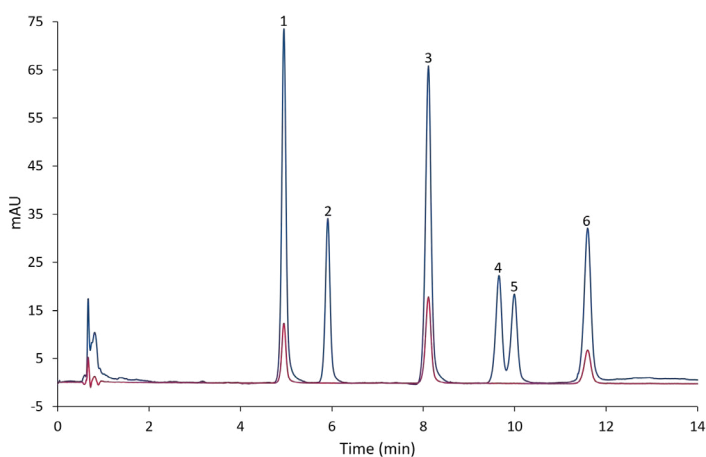
Additional Information

# Analyzing cannabis flowers according to the German Pharmacopeia - monograph 2018

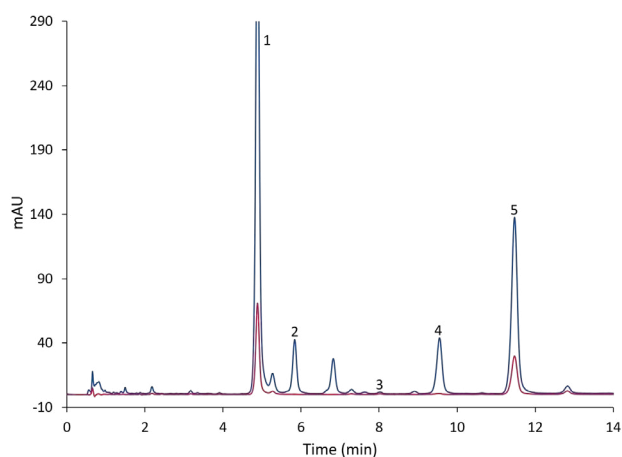
## RESULTS

The measured 10 µg/mL standard mix from the six different cannabinoids results in the chromatogram in **Fig. 1**. The measurement of the cannabis flower bediol (Bedrocan, Veendam, Netherlands) with a dilution of 1 to 10 with ethanol is shown in **Fig. 2**. The

repeatability for five cannabinoids was confirmed with a value of under 1% relative standard deviation over a six-time repetition of the bediol sample shown in **Tab. 1**. The relative retention compared to  $\Delta^9$ -THC is shown in **Tab. 2** with the given specifications.



**Fig. 1** Chromatogram of a 10 µg/mL standard mix measured with the DAB method; R=1.3 between  $\Delta^8$ -THC and  $\Delta^9$ -THC; blue - 225 nm, red - 306 nm, 1 - CBDA, 2 - CBD, 3 - CBN, 4 -  $\Delta^9$ -THC, 5 -  $\Delta^8$ -THC, 6 -  $\Delta^9$ -THCA.



**Fig. 2** Chromatogram of a 1 mg/mL bediol sample in ethanol; blue - 225 nm, red - 306 nm, 1 - CBDA, 2 - CBD, 3 - CBN, 4 -  $\Delta^9$ -THC, 5 -  $\Delta^9$ -THCA.

**Tab. 1** Results repeatability

Analyte	CBDA	CBD	CBN	$\Delta^9$ -THC	$\Delta^8$ -THC	$\Delta^9$ -THCA
Relative standard deviation [%]	0.26	0.89	0.84	0.34	-	0.14

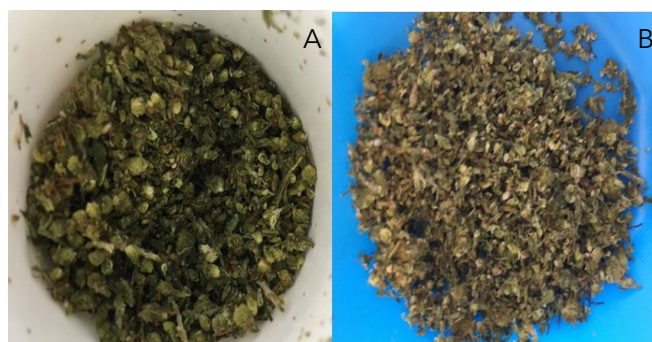
**Tab. 2** Results relative retention to  $\Delta^9$ -THC (9,56 min)

Analyte	CBDA	CBD	CBN	$\Delta^8$ -THC	$\Delta^9$ -THCA
Relative retention measured	0.51	0.61	0.84	1.05	1.20
Relative retention DAB	0.48	0.57	0.83	1.04	1.24



## SAMPLE PREPARATIONS

A 5 g portion of bediol was grinded with a flower grinder. The difference between grinded and original bediol is shown in **Fig. 3**. The sample preparation was performed according to DAB, where 500 mg substance was extracted three times with 15 mL ethanol on a laboratory shaker for 15 minutes with a following centrifugation at 5,000 rpm for 1 minute. Mixing all the extracts within 50 mL measuring flask, a 1:10 dilution was carried out and measured with the HPLC system after filtrating over a 0.45  $\mu\text{m}$  RC filter.



**Fig. 3** Bediol sample: original (A) and grinded (B).

## CONCLUSION

As shown in previous work for the DAB monograph 2017, the column Eurospher II C18P 100-3, 150x4.6 mm was determined as the most robust one while separating six different cannabinoids<sup>6</sup>. In the new monograph 2018 the change of the column dimensions results in an Eurospher II C18P 100-3, 150x3 mm. The additional modification of the gradient program compared to the 2017th monograph makes each chromatographic separation over 20 minutes faster. The measured chromatograms in this work show a sufficient separation of the six given cannabinoids. The

specification of the DAB with a critical resolution of  $R > 1.2$  for the critical analyte pair  $\Delta^8$ -THC and  $\Delta^9$ -THC is confirmed with  $R = 1.3$  within the measurements. The sample measurement of bediol shows a sufficient assignment of the signals, whereas the not identified signals can be assumed as matrix or not categorized cannabinoids. Additionally, the use of two different wavelengths shows a differentiation between the acid and neutral form of the cannabinoids. CBN as well shows an absorption towards 306 nm due to the increased amount of conjugated systems compared to  $\Delta^8$ -THC and  $\Delta^9$ -THC.

## REFERENCES

- [26] Gesetz über den Verkehr mit Betäubungsmitteln „Betäubungsmittelgesetz in der Fassung der Bekanntmachung vom 1. März 1994 (BGBl. I S.358), das zuletzt durch Artikel 1 der Verordnung vom 2. Juli 2018 (BGBl. I S.1078) geändert worden ist“. BtMG (1981).
- [27] Deutsches Arzneibuch 2018 (DAB). Allgemeiner Teil. Monographien Cannabisblüten-Cannabis flos. Deutscher Apotheker Verlag (2018).
- [28] Hoch, E., Friemel, C. M., Schneider, M. Cannabis. Eine Wissenschaftliche Bestandsaufnahme. Springer: Berlin, Heidelberg (2018).
- [29] Grotenhermen, F. Endogene Cannabinoide und das Endocannabinoidsystem. In: Handbuch Psychoaktive Substanzen. von Heyden, M., Jungaberle, H., Majic, T. Springer: Berlin, Heidelberg (2018).
- [30] Smith, B. C. Inter-lab variation in the cannabis industry. Part I: Problem and causes. Cannabis Science and Technology 2 (2), (2019).
- [31] Loxterkamp, L., Monks, K. Analyzing cannabis flowers according to the German Pharmacopeia - monograph 2017. KNAUER Wissenschaftliche Geräte GmbH (2019).

## MATERIALS AND METHODS

**Tab. 3** Used standards and solvents

Analyte	CAS	Purity / Concentration
Cannabidiol (CBD)	13956-29-1	1,000 mg/mL (MeOH)
Cannabidiolic acid (CBDA)	1244-58-2	1,000 mg/mL (ACN)
Cannabinol (CBN)	521-35-7	1,000 mg/mL (MeOH)
$\Delta^8$ -Tetrahydrocannabinol ( $\Delta^8$ -THC)	5957-75-5	1,000 mg/mL (MeOH)
$\Delta^9$ -Tetrahydrocannabinol ( $\Delta^9$ -THC)	1972-08-3	1,001 mg/mL (MeOH)
$\Delta^9$ -Tetrahydrocannabinolic acid ( $\Delta^9$ -THCA)	23978-85-0	1,000 mg/mL (ACN)
Solvent	CAS	Purity / Concentration
Acetonitril	75-05-8	Gradient grade
Ethanol	64-17-5	Gradient grade
H <sub>3</sub> PO <sub>4</sub>	7664-38-2	AnalaR 85% NORMAPUR

**Tab. 6** System configuration

Instrument	Description	Article No.
Pump	P 6.1 L	<a href="#">APH34EA</a>
Detector	MWD 2.1 L	<a href="#">ADB01</a>
Flow cell	10 mm, 10 $\mu$ L, Pressure proof	<a href="#">AMC38</a>
Autosampler	AS 6.1 L	<a href="#">AAA00AA</a>
Column thermostat	CT 2.1	<a href="#">A05852</a>
Column	Eurospher II 100-3 C18 P, 150 x 3 mm	<a href="#">15XE182E2G</a>
Software	Clarity Chrom 8.1	<a href="#">A1670</a>

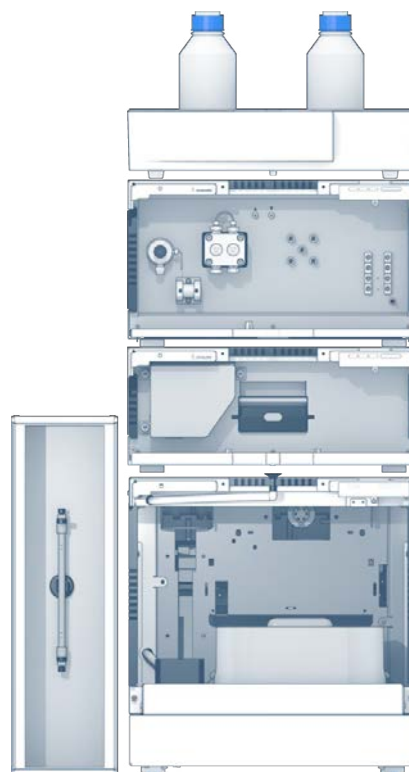
*KNAUER does not endorse the use of its products in connection with the illegal use, cultivation or trade of cannabis products. KNAUER does not endorse the illicit use of marijuana, we merely provide an overview of the methods and systems of cannabis analysis.*

**Tab. 4** Method

Column temperature	40 °C
Injection volume	10 $\mu$ L
Injection mode	Full loop
Detection	UV 225 nm / 306 nm
Data rate	10 Hz

**Tab. 5** Gradient

Eluent (A)	Water, HPLC grade (H <sub>3</sub> PO <sub>4</sub> 85% 8,64 g/L)		
Eluent (B)	Acetonitrile, Gradient grade		
Flow rate	1,0 mL/min		
	Time [min]	(A) %	(B) %
Pump program	0	36	64
	16	18	82
	17	36	64
	20	36	64



# Purify CBD and other cannabinoids by preparative HPLC

Yannick Krauke, Kate Monks; [applications@knauer.net](mailto:applications@knauer.net)

KNAUER Wissenschaftliche Geräte GmbH, Hegauer Weg 38, 14163 Berlin; [www.knauer.net](http://www.knauer.net).



## SUMMARY

The demand of pure cannabidiol (CBD) and other cannabinoids is increasing and therefore methods are needed that allow simultaneous purification of several cannabinoids from the same sample i.e. cannabis extract, paste or oil. Preparative HPLC is a well-established method for purification of target substances from natural substrates in high purities. In this application, a preparative HPLC method was developed for purification of CBD,  $\Delta^9$ -THC and CBC from a commercial CBD rich oil. All three cannabinoids were purified with high purity thus increasing the purity of the main component CBD from 72% to 93%.

## INTRODUCTION

*Cannabis sativa* is used in agricultural and medical applications for already long time. It contains a variety of compounds such as terpenoids, flavonoids and cannabinoids among which tetrahydrocannabinol ( $\Delta^9$ -THC) and cannabidiol (CBD) are the most abundant<sup>1</sup>.  $\Delta^9$ -THC is known for its psychoactive effects and is applied as medical treatment, but underlies strict legal regulations in most countries. CBD does not have the intoxicating effects of THC, and therefore the legislations are much more relaxed, yet. Depending on the field of application there are cannabis breeds with high THC content and others with low THC but high CBD content. As CBD shows medicinal effects as THC and is used i.e. for the treatment of neuropathic pain and chronic inflammatory conditions, the demand is growing. Many products such as CBD oil, drops and cosmetics are also available on the market<sup>2,3,4,5</sup>. The demand of highly pure CBD and other cannabinoids

is increasing, and therefore different purification strategies are developed. If the goal is to purify CBD from a sample, in most cases a pre-processed paste from CBD rich hemp, besides preparative HPLC flash or centrifugal partition chromatography (CPC) could be applied. If the aim is to purify several different cannabinoids from the same sample, preparative HPLC has its advantages. Here the purification of CBD,  $\Delta^9$ -THC and CBC (cannabichromen) from a CBD oil using a KNAUER AZURA preparative HPLC system is described. Further, the whole process from sample analysis to method development in analytical scale, the scale up to preparative scale and finally the purification of target cannabinoids is shown. Due to strict regulatory conditions concerning the novel food legislation in 2019, it was difficult to acquire a CBD rich paste or other CBD process sample. Exemplarily, a commercial CBD rich oil was used as sample.

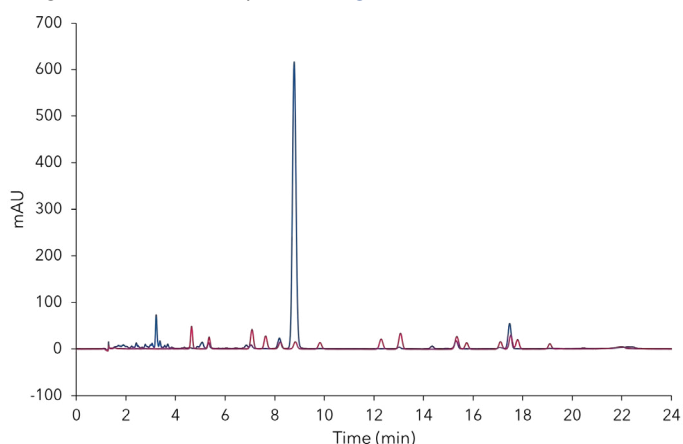


Additional Information

# Purify CBD and other cannabinoids by preparative HPLC

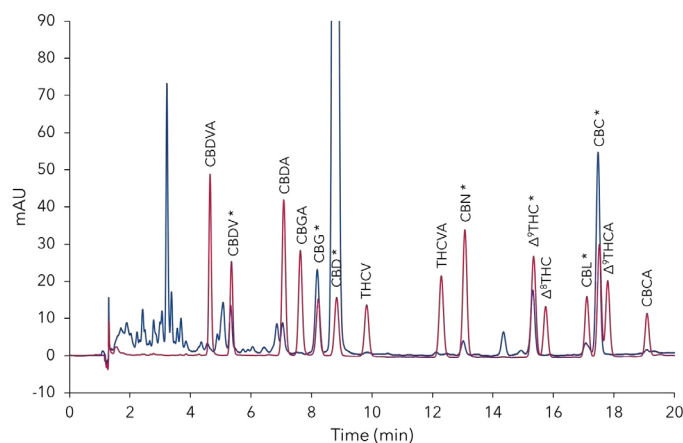
## RESULTS

The CBD-Loges oil was analyzed with the previously described acetonitrile method<sup>6</sup>. The CBD oil chromatogram showed one large peak at tR 8.9 min and several significant smaller peaks (Fig. 1).



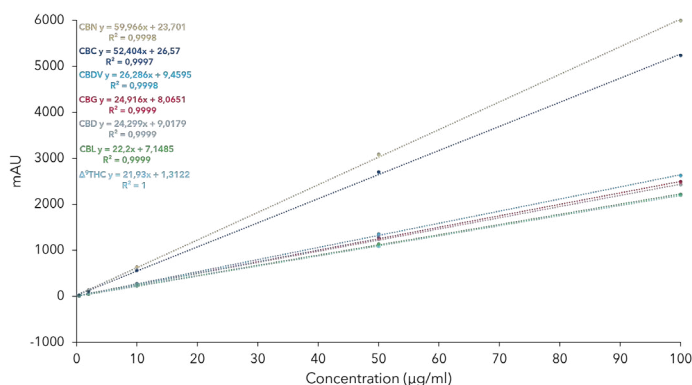
**Fig. 1** Overlay chromatograms of CBD oil sample (blue) and mixture of 16 Cannabinoids (red). CBD oil sample 5 mg/ml; standard concentration 5 µg/ml each; 10 µl injection, 228 nm; C18P, 3 µm, 150 x 4.6 mm ID.

Most impurities eluted within the first five minutes (Fig. 2). An overlay of the chromatograms of a standard mixture and the mixture of 16 cannabinoids, as well as a subsequent retention time comparison led to the identification of seven cannabinoids: CBDV, CBG, CBD, CBN, Δ<sup>9</sup>-THC, CBL and CBC. A larger, early eluting peak group eluted within the first 5 minutes, and two larger unidentified peaks at approximately 5 and 14.4 minutes (Fig. 2).



**Fig. 2** Detailed view of Fig. 1 with the 16 cannabinoids standard mixture. Positive identified substance peaks are highlighted with \* in sample.

A five-point calibration curve for the seven cannabinoids was measured and the resulting coefficients were above  $R > 0.999$  for all seven cannabinoids (Fig. 3).



**Fig. 3** Calibration curves and linearity for the cannabinoids CBDV, CBG, CBD, CBN, Δ<sup>9</sup>-THC and CBL for analytical ACN method at 228 nm.

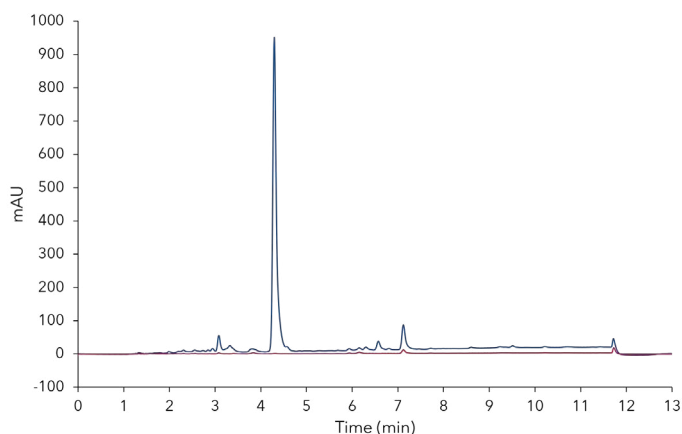
The calibration was used for the analysis of the CBD oil sample. The area % was used to quantify the purity of the identified cannabinoids. The results show that CBD is the most abundant cannabinoid in the sample with approximately 73% (area) followed by CBC with 5.7% (area). In the integration interval 15.6% (area) of the sample were unidentified peaks, other cannabinoids and impurities (Tab. 1). The calculated cannabinoids percentages in 1 mg CBD oil are 5.09% CBD and 0.17% Δ<sup>9</sup>THC which are close to the manufacture indications (5.35% CBD and <0.2% Δ<sup>9</sup>-THC). Content of CBC (0.18%) and CBG (0.17%) are similar to Δ<sup>9</sup>-THC (Tab. 1).

**Tab. 1** Analysis composition of identified cannabinoids in CBD oil sample (5 mg/ml). Integration interval 1.5 min – 20 min; global width 0.1 min; global threshold 0.1 mAU.

	Area %	Concentration ug/ml	% in 1 mg CBD oil
CBDV	1.00	2.86	0.06
CBG	2.50	8.49	0.17
CBD	71.90	254.34	5.09
CBN	0.60	0.40	0.01
Δ <sup>9</sup> -THC	2.20	8.36	0.17
CBL	0.50	1.92	0.04
CBC	5.70	8.88	0.18
others	15.60		

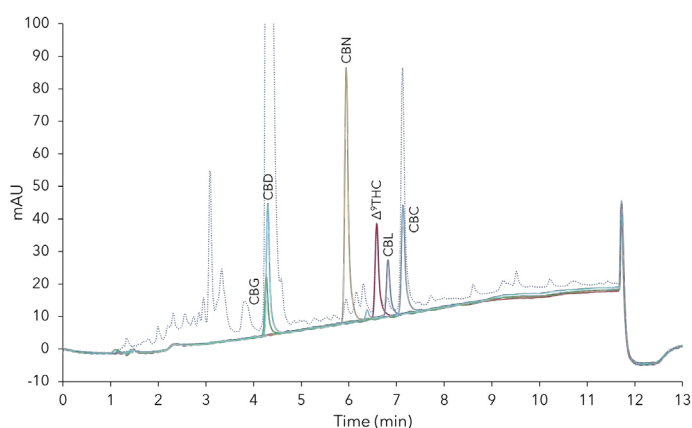
## RESULTS

After the analysis of the sample, a purification method was developed to purify CBD with higher purity. Additionally,  $\Delta^9$ -THC and CBC should be purified with the same method to show the possibility to purify several different cannabinoids from one sample in one run. A fast methanol gradient method was developed in analytical scale with a total run time of 13 minutes (Fig. 4; Tab. 5).



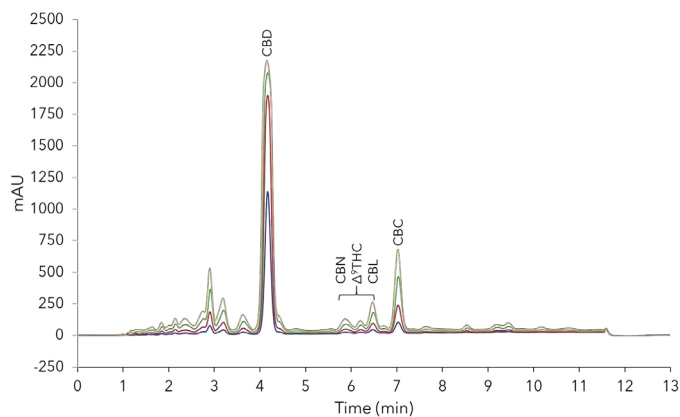
**Fig. 4** CBD oil sample (5 mg/ml) with optimized methanol gradient method at 228 nm (blue) and 306 nm (red); C18, 3  $\mu$ m, 150 x 4.6 mm ID.

Comparison of the chromatograms of the CBD oil sample and six cannabinoid standard chromatograms allowed the mapping of those (Fig. 5). CBG and CBD are nearly coeluting. Therefore purified CBD will contain always CBG using this method. The four other identified cannabinoids were eluting close to each other, but a distinct separation of  $\Delta^9$ -THC and CBC looked promising (Fig. 5).



**Fig. 5** Detailed view overlay of CBD oil sample and single standard chromatograms. CBD-Loges oil (dashed line), standards in elution order: CBG (5  $\mu$ g/ml), CBD (10  $\mu$ g/ml), CBN (10  $\mu$ g/ml),  $\Delta^9$ -THC (10  $\mu$ g/ml), CBL (5  $\mu$ g/ml), CBC (5  $\mu$ g/ml), C18, 3  $\mu$ m, 150 x 4.6 mm ID.

The optimized method was transferred to a C18 column with similar length and inner diameter but larger particle size (10  $\mu$ m), which correspond to the particle size of the later preparative column. The maximum solubility of the oil in methanol/water (75%/25% v/v) was 50 mg/ml. Larger quantities were not soluble (data not shown). A volume overload study with a 50 mg/ml CBD oil sample was performed on this column. The results showed that even with 15  $\mu$ l injections the CBD peak had nearly linear absorption behaviour (Fig. 6).

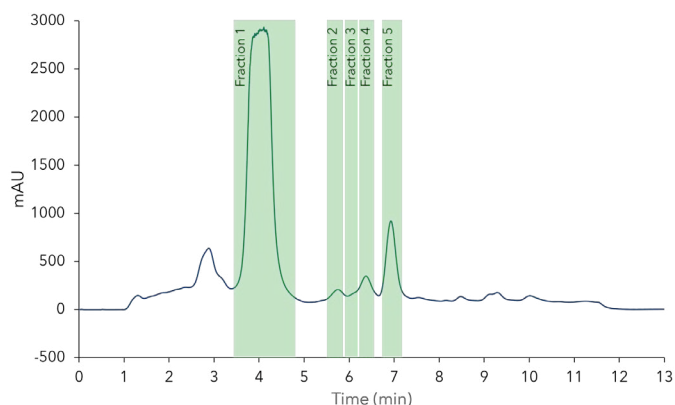


**Fig. 6** Volume overload study with methanol method on C18 10  $\mu$ m particle. 2  $\mu$ l, 5  $\mu$ l, 10  $\mu$ l, 15  $\mu$ l injection of 50 mg/ml CBD-Loges sample; C18, 10  $\mu$ m, 150 x 4.6 mm ID.

# Purify CBD and other cannabinoids by preparative HPLC

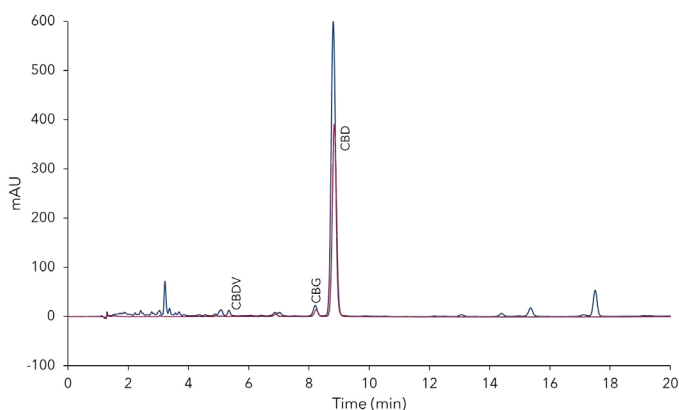
## RESULTS

The increase of particle size slightly decreased the resolution, but it was still suitable for purification of the target compounds. A linear up-scaling of the method was performed. The column inner diameter (ID) was increased from 4.6 mm to 20 mm. The flow rate was increased from 1.2 ml/min to 23 ml/min. Parameters were calculated with the KNAUER ScaleUp Converter. Different injection volumes were tested starting from 200  $\mu$ l up to 2000  $\mu$ l of 50 mg/ml CBD oil sample. From the 2 ml injection run five fractions were collected with the aim to purify CBD/CBG,  $\Delta^9$ -THC and CBC (Fig. 7).



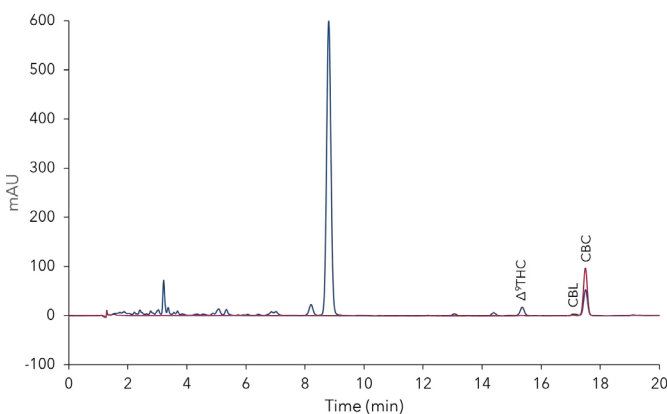
**Fig. 7** Preparative purification of CBD. 2 ml sample 50 mg/ml injection and fractionation; C18, 10  $\mu$ m, 150 x 20 mm ID.

Automated fractionation was carried out by signal threshold of the PurityChrom® Software. The collected fractions were analyzed and the chromatograms were compared to the chromatogram of the injected CBD oil sample. The results clearly showed that only CBD, CBG and small amount of impurities were detected in fraction 1, but none of the early and late eluting compounds (Fig. 8).



**Fig. 8** Analysis of fraction 1 (red) from Fig. 7 and overlay with sample chromatogram (blue). 10  $\mu$ l injection; analytical ACN method.

Whereas in fraction 5 mainly CBC is present (Fig. 9).



**Fig. 9** Analysis of fraction 5 (red) from Fig. 7 and overlay with sample chromatogram (blue). 10  $\mu$ l injection; analytical ACN method.

The other fractions are not shown. The area percentages (indicator for purity) of the tested cannabinoids and the percentage of the total amount were determined for

## RESULTS

the five collected fractions (Tab. 2). In fraction 1 all of CBG and CBD were collected. The purity of CBD was increased from approximately 72% in the CBD oil to 93% in fraction 1. The fractions 2 and 3 contained a mixture of different cannabinoids but also high amounts

>65% (area %) of unidentified compounds. The fraction 4 contained mainly  $\Delta^9$ -THC (~ 80%) and most of it from the sample (~ 90%). The fraction 5 contained 100% of the CBC with purity of approximately 97% (Tab. 2).

**Tab. 2** Analysis of fractions from preparative purification (2 ml injection with 50 mg/ml) of cannabinoids from CBD oil sample. For each fraction area % of identified cannabinoids and % from total sample are shown. Integration interval 1.5 min - 20 min; global width 0.1 min; global threshold 0.1 mAU.

Sample	Fraction 1		Fraction 2		Fraction 3		Fraction 4		Fraction 5			
	Area %	Total amount in sample (mg)	Area %	% of sample	Area %	% of sample	Area %	% of sample	Area %	% of sample		
CBDV	1.00	0.57	0.20	0.00	0.00	0.00	0.00	0.00	0.00	0.00	0.00	0.00
CBG	2.50	1.70	3.40	100.00	0.00	0.00	0.00	0.00	0.00	0.00	0.00	0.00
CBD	71.90	50.87	93.20	100.00	0.00	0.00	0.00	0.00	0.00	0.00	0.00	0.00
CBN	0.60	0.08	0.00	0.00	32.70	100.00	1.50	0.00	0.00	0.00	0.00	0.00
$\Delta^9$ -THC	2.20	1.67	0.00	0.00	3.10	1.60	17.80	6.26	80.10	88.57	1.20	3.58
CBL	0.50	0.38	0.00	0.00	0.00	0.00	12.20	27.85	0.00	n/a	1.20	72.15
CBC	5.70	1.78	0.00	0.00	0.00	0.00	0.00	0.00	1.50	0.00	96.70	100.00
others	15.60		3.20		64.20		68.50		18.40		0.90	

# Purify CBD and other cannabinoids by preparative HPLC

## SAMPLE PREPARATIONS

A commercially available CBD rich oil was used for the application (CBD-Loges, 10 ml, with hemp extract containing 5.35% CBD). This oil contained also high amount of sesame oil. The oil was diluted in methanol to indicated concentration (i.e. 5 mg/ml) and sonicated for 15 minutes. After 10 minutes of settling the solution was filtered through 0.2 µm PTFE syringe filter to remove the unpolar part of the mixture. For higher oil concentrations (50 mg/ml) filtration and settling were

repeated. Cannabinoid calibration standards were prepared from 1 mg/ml cannabinoid standard solution (**Tab. 3**) and diluted with methanol to indicated concentrations. The standards were prepared in two mix solution, mix 1 (CBDV, CBG, CBD, CBN) and mix 2 ( $\Delta^9$ -THC, CBL, CBC). A five-point calibration curve with 0.4 µg/ml, 2 µg/ml, 10 µg/ml, 50 µg/ml, 100 µg/ml of each of the seven identified cannabinoids was established.

## CONCLUSION

The analysis of the CBD-Loges oil showed that the main cannabinoid was CBD with a 72% purity. The manufacturer's information that the oil contains 5.35% CBD and <0.2%  $\Delta^9$ -THC could be confirmed with results from analysis (5.09% CBD and 0.17%  $\Delta^9$ -THC). A preparative methanol based step-gradient method was developed to purify CBD,  $\Delta^9$ -THC and CBC in high purities from the CBD oil. CBD was purified with 100% recovery resulting in a yield of 5.09 mg CBD from a 100 mg CBD oil injection ( 2 ml of 50 mg/ml solution). The results proved the simplicity of a linear scale up and the advantages to perform method optimization in analytical scale. This approach saves time, sample and solvent. The shown method is an example and was targeted at three cannabinoids. Depending on the target cannabinoids, the method could be adapted. It is important to mention that the yield could be significantly improved by using a sample with higher concentrations of the target compounds. Nevertheless, the same KNAUER AZURA preparative HPLC system could be used. Also, changing the solvent to ethanol, acetonitrile or even normal phase could be possible, but then the method development has to be started from the beginning.

*KNAUER does not endorse the use of its products in connection with the illegal use, cultivation or trade of cannabis products. KNAUER does not endorse the illicit use of marijuana, we merely provide an overview of the methods and systems of cannabis analysis and purification.*



## MATERIALS AND METHODS

**Tab. 3** Standard solutions and samples

Analyte	CAS	Purity / Concentration
Cannabichromene (CBC)	20675-51-8	0.972 mg/ml (MeOH)
Cannabidivarin (CBDV)	24274-48-4	0.986 mg/ml (MeOH)
Cannabidiol (CBD)	13956-29-1	1.000 mg/ml (MeOH)
Cannabigerol (CBG)	25654-31-3	0.995 mg/ml (MeOH)
Cannabinol (CBN)	521-35-7	1.000 mg/ml (MeOH)
Cannabicyclol (CBL)	21366-63-2	0.992 mg/ml (ACN)
$\Delta^9$ -Tetrahydrocannabinol ( $\Delta^9$ -THC)	1972-08-3	1.001 mg/ml (MeOH)

Solvent	CAS	Purity / Concentration
Acetonitril	75-05-8	Gradient grade
H <sub>3</sub> PO <sub>4</sub>	7664-38-2	AnalaR 85% NORMAPUR
Methanol	67-56-1	Gradient grade

Sample	Manufacturer	Batch
CBD-Loges (Cannabis oil)	Dr. Loges	MA-19160911-2

**Tab. 5** Analytical and preparative gradient methanol method

	Analytical	Preparative
Column temperature	25 °C	RT
Injection volume	x $\mu$ l	2000 $\mu$ l
Injection mode	Partial Loop	Full loop
Detection	UV 228 nm / 306 nm	UV 228 nm
Data rate	10 Hz	2 Hz

Gradient			
Eluent (A)	Water		
Eluent (B)	Methanol, Gradient grade		
Flow rate	1.2 ml/min (analytical)	23 ml/min (preparative)	
	Time (min)	A (%)	B (%)
Pump program	0	15	85
	8	0	100
	10	0	100
	10.02	15	85
	13	15	85

**Tab. 4** Analytical acetonitril method

Column temperature	25 °C		
Injection volume	10 $\mu$ l		
Injection mode	Partial loop		
Detection	UV 225 nm/306 nm		
Data rate	10 Hz		

Gradient			
Eluent (A)	Water, HPLC grade pH 2.2 (H <sub>3</sub> PO <sub>4</sub> 85%)		
Eluent (B)	Acetonitrile, gradient grade		
Flow rate	1.0 ml/min		
	Time (min)	A (%)	B (%)
Pump program	0	25	75
	7	25	75
	17	10	90
	19	10	90
	20	25	75
	25	25	75

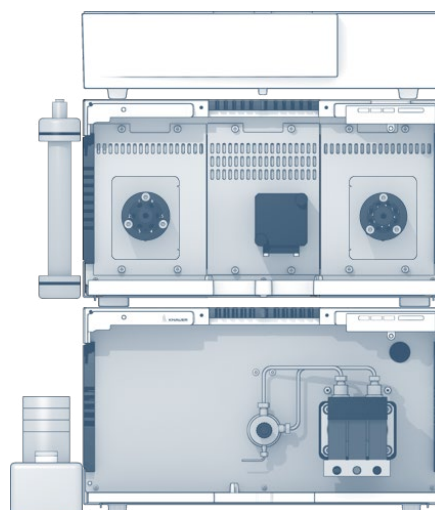
**Tab. 6** Analytical system configuration

Instrument	Description	Article No.
Pump	AZURA P 6.1L LPG 10 ml/min, sst	<a href="#">APH34EA</a>
Autosampler	AZURA AS 6.1L, 700 bar	<a href="#">AAA00AA</a>
Detector	AZURA DAD 2.1L	<a href="#">ADC01</a>
Puls Damper	High volume, stainless steel	<a href="#">AZZ00NB</a>
Flow cell	Light guide 10mm/10 $\mu$ l/ 300 bar	<a href="#">AMC38</a>
Thermostat	AZURA CT2.1	<a href="#">A05852</a>
Column	Eurospher II 100-3 C18P, 150 x 4.6 mm ID	<a href="#">15EE182E2G</a>
Column	Eurospher II 100-3 C18, 150 x 4.6 mm ID	<a href="#">15VE181E2G</a>
Column	Eurospher II 100-10 C18, 150 x 4.6 mm ID	<a href="#">15EE181E2N</a>
Software	ClarityChrom 8.1 - Workstation, autosampler control included	<a href="#">A1670</a>
Software	ClarityChrom 8.1 - PDA extension	<a href="#">A1676</a>

## MATERIALS AND METHODS

Tab.7 Preparative system configuration

Instrument	Description	Article No.
Pump	AZUAR P2.1L, 100 ml/min, sst	<a href="#">APE20KA</a>
Ternary LGP module	AZURA LPG ternary module for Pump P 2.1L	<a href="#">AZZ00AB</a>
Assistant	AZURA ASM 2.2L Left: V4.1 + 6Port2Pos, 1/16", sst, 500 bar Middle: UVD 2.1S Right: V 4.1 + 8Mpos, 1/8", sst, 200 bar	<a href="#">AY00593</a> <a href="#">AVD26AE</a> - <a href="#">AVU34AE</a>
Flow cell	3 µl; 1/16"	<a href="#">A4069</a>
Dynamic mixer	Preparative HPLC, sst, 1/8", 250V	<a href="#">A0581</a>
Column	Eurospher II 100-10 C18, Column 150x20 mm	<a href="#">15JE181E2N</a>
Software	PurityChrom®Basic	<a href="#">A2650</a>



## REFERENCES

- [32] Bonini, S. A. et al. Cannabis sativa: A comprehensive ethnopharmacological review of a medicinal plant with a long history. *Journal of Ethnopharmacology* 227:300-315 (2018).
- [33] Amin, M. R., Ali, D. W. Pharmacology of Medical Cannabis. *Advances in Experimental Medicine and Biology* 1162:151-165 (2019).
- [34] ElSohly, M. A. et al. Phytochemistry of Cannabis sativa L. *Progress in the Chemistry of Organic Natural Products* 103:1-36 (2017).
- [35] Lafaye, G., Karila, L., Blecha, L., Benyamina, A. Cannabis, cannabinoids, and health. *Dialogues in Clinical Neuroscience* 19(3): 309-316 (2017).
- [36] Pisanti, S. et al. Cannabidiol: State of the art and new challenges for therapeutic applications. *Pharmacology & Therapeutics* 175:133-150 (2017).
- [37] Loxterkamp, L., Monks, K. (C)an(n)alyze: determination of 16 cannabinoids inside flowers, oils and seeds. *KNAUER Wissenschaftliche Geräte GmbH* (2020).

## RELATED KNAUER APPLICATIONS

[VPH0070](#) - (C)an(n)alyze: determination of 16 cannabinoids inside flowers, oils and seeds

[VPH0072](#) - Analyzing cannabis flowers according to the German Pharmacopeia - monograph 2018

# Purification of cannabidiol from CBD oil by preparative HPLC



Yannick Krauke, Kate Monks; applications@knauer.net

KNAUER Wissenschaftliche Geräte GmbH, Hegauer Weg 38, 14163 Berlin; www.knauer.net.

## SUMMARY

The demand of pure cannabidiol (CBD) is increasing and therefore methods are needed that allow purification of CBD in high purity from different kind of samples i.e. cannabis extract, paste or oil. Preparative HPLC is a well-established method for purification of target substances from natural substrates in high purities and was therefore applied for this task. In this application a preparative HPLC method was developed for purification of CBD from a commercial CBD rich oil. CBD was purified with high purity and recovery thus increasing the purity from 71.6% to 94.5%.

## INTRODUCTION

*Cannabis sativa* is used in agricultural and medical applications already for a long time. It contains a variety of compounds such as terpenoids, flavonoids and cannabinoids among which tetrahydrocannabinol ( $\Delta^9$ -THC) and cannabidiol (CBD) are the most abundant<sup>1</sup>.  $\Delta^9$ -THC is known for its psychoactive effects and is applied as medical treatment, but underlies strict legal regulations in most countries. CBD does not have the intoxicating effects of THC, and therefore the legislations are much more relaxed, yet. Depending on the field of application there are cannabis breeds with high THC content and others with low THC but high CBD content. As CBD shows medicinal effects as THC and is used i.e. for the treatment of neuropathic pain and chronic inflammatory conditions, the demand is growing. Many products such as CBD oil, drops and cosmetics are also available

on the market<sup>2,3,4,5</sup>. The demand of highly pure CBD and other cannabinoids is increasing, and therefore different purification strategies are developed. Here, the purification of CBD from a CBD oil is described using a KNAUER AZURA<sup>®</sup> preparative HPLC system. An already described methanol-based gradient purification method was optimized for the purification of solely CBD<sup>7</sup>. Further, the whole process from sample analysis over method development in analytical scale, the scale-up to preparative scale and finally the purification of CBD is shown. Due to strict regulatory conditions concerning the novel food legislation in 2019, it was difficult to acquire a CBD rich paste or other CBD process sample. For this reason, a commercial CBD rich oil was used as sample.

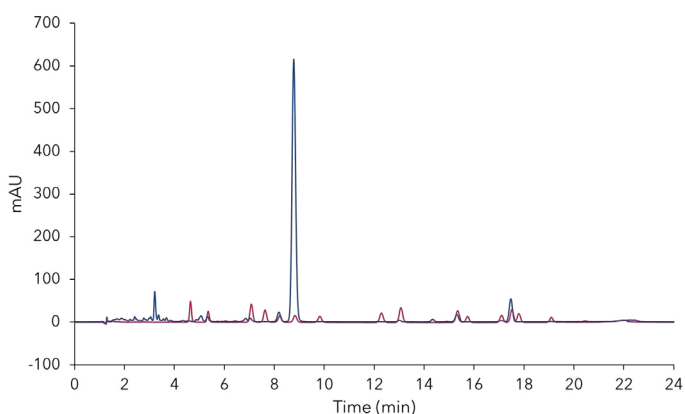


Additional Information

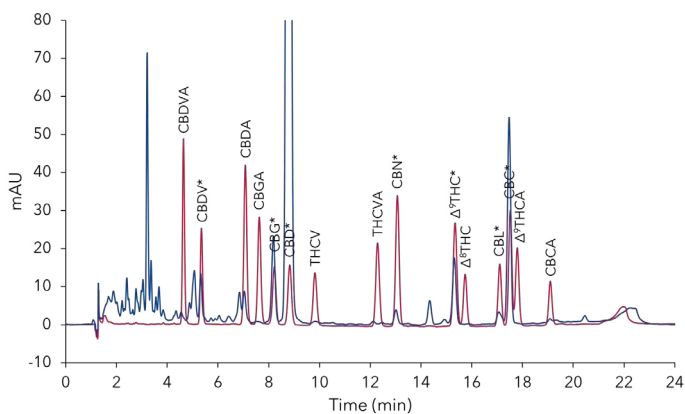
# Purification of cannabidiol from CBD oil by preparative HPLC

## RESULTS

The CBD-Loges<sup>®</sup> oil was analyzed with the previously described acetonitrile method<sup>6</sup>. The chromatogram of the CBD oil showed one large peak at  $t_R$  8.9 min and several significant smaller peaks (Fig. 1 and Fig. 2). Most impurities eluted within the first 5 minutes (Fig. 2). An overlay with the chromatogram of a standard mixture of 16 cannabinoids and subsequent retention time comparison led to the identification of seven cannabinoids: CBDV, CBG, CBD, CBN,  $\Delta^9$ THC, CBL and CBC (Fig. 2). A larger, early eluting peak group eluted within the first 5 minutes, and two larger unidentified peaks at approximately 5 and 14.4 minutes (Fig. 2).



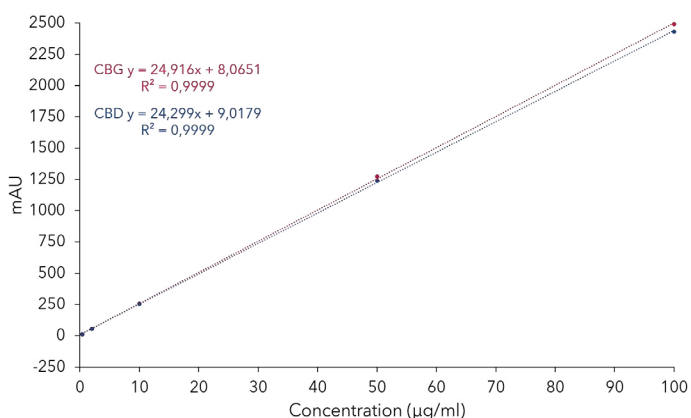
**Fig. 1** Overlay chromatograms of CBD oil sample (blue) and mixture of 16 cannabinoids (red). CBD oil sample 5 mg/ml; standard concentration 5  $\mu$ g/ml each; 10  $\mu$ l injection, 228 nm; C18P, 3  $\mu$ m, 150 x 4.6 mm ID.



**Fig. 2** Detailed view of Fig. 1 with the 16 cannabinoids standard mixture. Positive identified substance peaks are highlighted with \* in sample.

A five-point calibration curve for CBD and CBG was

measured and the resulting coefficients were above  $R > 0.999$  for both cannabinoids (Fig. 3). The calibration was used for the analysis of the CBD oil sample.



**Fig. 3** Calibration curves and linearity for the cannabinoids CBG and CBD for analytical ACN method at 228 nm.

The results show that CBD is the most abundant cannabinoid in the sample with approximately 72% (area), while the CBG content is 2.6%. The remaining 25.8% (area) were accounted for other cannabinoids, impurities, and unidentified peaks (Tab. 1). The calculated CBD percentages in 1 mg CBD oil were 5.29% CBD which is close to the manufacture indications of 5.35% CBD.

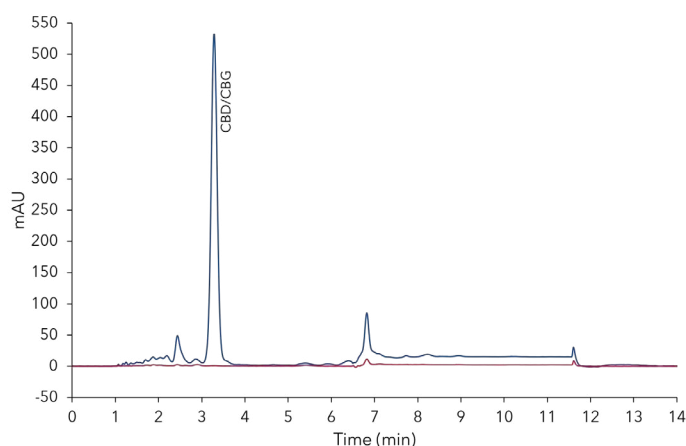
**Tab. 1** Analysis composition of identified cannabinoids in CBD oil sample (5 mg/ml). Integration interval 1.5 min - 20 min; global width 0.1 min; global threshold 0.1 mAU.

	Area %	Concentration ug/ml	% in 1 mg CBD oil
CBG	2.60	12.07	0.24
CBD	71.60	264.55	5.29
others	25.80		

Next, a purification method was developed to purify CBD with higher purity. In contrast to a previous developed method where several cannabinoids were purified<sup>7</sup>, here CBD was the only target substance. A methanol-based two-step gradient method was developed in analytical scale on a C18 column with

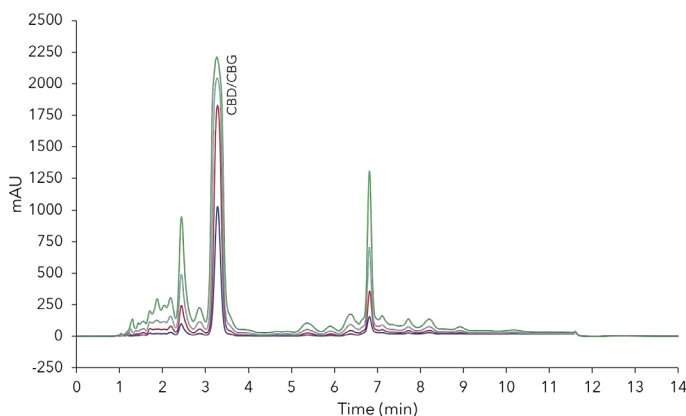
## RESULTS

10  $\mu\text{m}$  particle size (Fig. 4; Tab. 6). Comparison of the chromatograms of the CBD oil sample, CBD and CBG standard chromatograms revealed nearly co-elution of both substances in the main peak  $t_{\text{R}}$  3.3 min (Fig. 4).



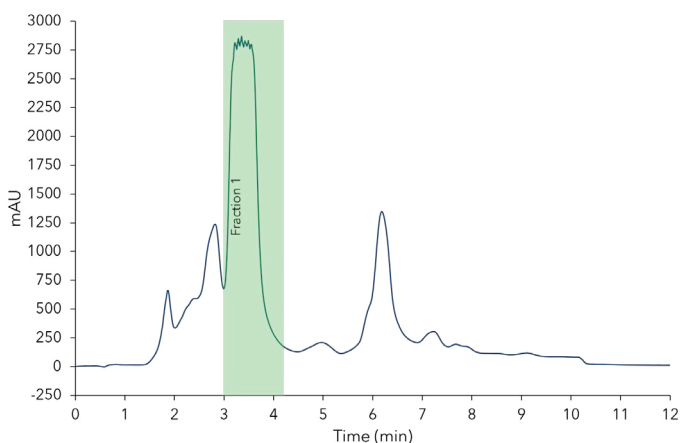
**Fig. 4** CBD-Loges oil sample (5 mg/ml) with two-step gradient methanol method at 228 nm (blue) and 306 nm (red); C18, 3  $\mu\text{m}$ , 150 x 4.6 mm ID.

The maximum solubility of the oil in methanol/water (75%/25%, v/v) was 50 mg/ml. Larger quantities were not soluble (data not shown). A volume overload study injecting different sample volumes with a 50 mg/ml CBD oil sample was performed. The results showed that also with 20  $\mu\text{l}$  injections the CBD peak had nearly linear absorption behaviour (Fig. 5).



**Fig. 5** Volume overload study. 2  $\mu\text{l}$  (blue), 5  $\mu\text{l}$  (red), 10  $\mu\text{l}$  (grey) and 20  $\mu\text{l}$  (green) injection of 50 mg/ml CBD-Loges oil sample; C18, 10  $\mu\text{m}$ , 150 x 4.6 mm ID.

A linear up-scaling of the method was performed to increase the yield. The column ID was increased from 4.6 mm to 50 mm and the flow rate from 1.2 ml/min to 140 ml/min (Tab. 7). Parameters were calculated with the KNAUER ScaleUp Converter. By enlarging the column diameter, the injection volume was increased. The sample was injected with one channel of the major pump using the ternary LPG module thus reducing the need of an injection valve and therefore simplifying the preparative HPLC system. Pre-mixed solvents were used. The sample injection was performed with a lower flow rate than the main flow to guaranty a more precise sample injection (Tab. 7). As the sample amount and solvent consumption were high, no test runs were performed and the target peak manually collected immediately during the first run of a 15 ml sample injection (Fig. 6).

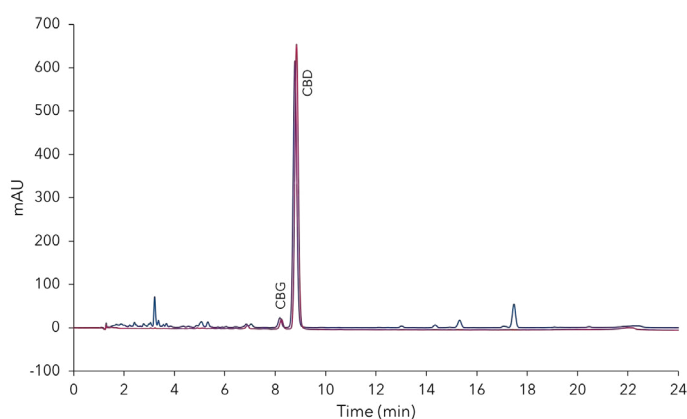


**Fig. 6** Preparative purification of CBD. 15 ml sample with 50 mg/ml injection and fractionation of CBD peak. C18, 10  $\mu\text{m}$ , 150 x 50 mm ID.

The PurityChrom software allows these direct interactions during the run. The collected fraction was analyzed, and the chromatogram compared to the chromatogram of the injected CBD oil sample. The results clearly showed that only CBD, CBG and a small amount of impurities were detected, but none of the early or late eluting compounds (Fig. 7).

# Purification of cannabidiol from CBD oil by preparative HPLC

## RESULTS



**Fig. 7** Analysis of the CBD fraction from Fig. 5 and overlay with CBD oil sample chromatogram. 10 µl injection, analytical ACN method.

The area percentages (indicator for purity) of CBD and CBG, and the percentage of the total amount were determined for the collected fraction (**Tab. 2**).

**Tab. 2** Analysis of fractions from preparative purification (15 ml injection with 50 mg/ml) of cannabinoids from CBD oil sample. For each fraction area % of identified cannabinoids and % from total sample are shown. Integration interval 1.5 min – 20 min; global width 0.1 min; global threshold 0.1 mAU.

	Sample		Fraction 1	
	Area %	Approx. mg in 15 ml sample	Area %	Approx. mg in fraction
CBG	2.60	1.80	3.10	1.30
CBD	71.60	39.7	94.50	42.50
others	25.80		2.40	

The purity of CBD was increased from approximately 71.6% in the CBD oil to 94.5% in the collected fraction. The total amount of CBG in the 15 ml injected sample (750 mg CBD oil) was approximately 40 mg. For the collected fraction, the CBG content was approximately 42.5 mg. The difference between the two values can be due to small errors caused by factors such as dilution steps. It can be assumed that the CBG was completely recovered by the fractionation.

**Tab. 3** Sample and CBD throughput per day with tested parameters

Method	
Column dimension	150x50 mm
Flow rate	140 ml/min
Run time	12 min
Sample conc. (CBD oil)	50 mg/ml
Injection volume	15 ml
Sample amount	750 mg
CBD content	5.3%
CBD purity	71.6%
CBD amount	40 mg

Results purification	
CBD purity	94%
CBD recovery	100%
CBD yield	40 mg

Throughput	Load (750 mg/run)	CBD (40 mg/run)
5 runs (12 min)/hour	3.75 g/h	0.2 g/h
8h/day	30 g/d	1.6 g/d

## SAMPLE PREPARATIONS

A commercially available CBD rich oil was used for this application (CBD-Loges oil, 10 ml, with hemp extract containing 5.35% CBD). This oil contained also a high amount of sesame oil. The oil was diluted in methanol to indicated concentration (i.e. 5 mg/ml) and sonicated for 15 minutes. After 10 minutes of settling the solution was filtered through 0.2 µm PTFE syringe filter to remove the unpolar part of the mixture. For higher

oil concentrations (50 mg/ml) filtration and settling were repeated. Cannabinoid calibration standards were prepared from 1 mg/ml cannabinoid standard solution (**Tab. 4**) and diluted with methanol to indicated concentrations. A five-point calibration curve with 0.4 µg/ml, 2 µg/ml, 10 µg/ml, 50 µg/ml, 100 µg/ml of each of CBD and CBG was established.

## CONCLUSION

The analysis of the CBD-Loges oil showed that the main cannabinoid was CBD with 71.6% purity. The manufacturer's information that the oil contains 5.35% CBD was confirmed with results from analysis that calculated 5.29% CBD in the sample. A preparative two-step gradient method based on methanol was developed to purify CBD in high purity and yield from the CBD oil. From a 15 ml sample injection (750 mg CBD oil) approximately 40 mg CBD with 94.5% purity were purified. The low yield of the described process is due to the low concentration of CBD in the sample. The total sample throughput is higher than the yield (**Tab. 3**). These results clearly highlight that the yield of a process is not only depended on the throughput but also from the target concentration in the sample and of the solubility in the solvent. Increasing the

target concentration in the sample and finding a better solvent would significantly increase the yield and productivity. The results proved the simplicity of a linear scale-up and the advantages to perform method optimization in analytical scale. This approach saves time, sample and solvent. It also shows how a simple preparative AZURA HPLC system with a pump, a single wavelength detector and a fractionation valve is used to purify highly pure target substances from a sample. Fractionation was performed manually to avoid test runs and thus spare sample and solvent. This method could be changed to other solvents such as ethanol, acetonitrile, or even normal phase but then the method development must be started from the beginning.

*KNAUER does not endorse the use of its products in connection with the illegal use, cultivation or trade of cannabis products. KNAUER does not endorse the illicit use of marijuana, we merely provide an overview of the methods and systems of cannabis analysis and purification.*

# Purification of cannabidiol from CBD oil by preparative HPLC

## MATERIALS AND METHODS

**Tab. 4** Standard solutions and samples

Analyte	CAS	Purity / Concentration
Cannabidiol (CBD)	13956-29-1	1.000 mg/ml (MeOH)
Cannabigerol (CBG)	25654-31-3	0.995 mg/ml (MeOH)

Solvent	CAS	Purity / Concentration
Acetonitril	75-05-8	Gradient grade
H <sub>3</sub> PO <sub>4</sub>	7664-38-2	AnalaR 85% NORMAPUR
Methanol	67-56-1	Gradient grade

Sample	Manufacturer	Batch
CBD-Loges oil (Cannabis oil)	Dr. Loges	MA-19160911-2

**Tab. 6** Analytical methanol method

Column temperature	25 °C
Injection volume	10 µl
Injection mode	Partial loop
Detection	UV 228 nm/306 nm
Data rate	10 Hz

### Gradient

Eluent (A)	Water		
Eluent (B)	Methanol, Gradient grade		
Flow rate	1.2 ml/min		
	Time (min)	A (%)	B (%)
Pump program	0	10	90
	5	10	90
	5.02	0	100
	10	0	100
	10.02	10	90
	15	10	90

**Tab. 5** Analytical acetonitril (ACN) method

Column temperature	25 °C
Injection volume	10 µl
Injection mode	Partial loop
Detection	UV 225 nm/306 nm
Data rate	10 Hz

### Gradient

Eluent (A)	Water, HPLC grade pH 2.2 (H <sub>3</sub> PO <sub>4</sub> 85%)		
Eluent (B)	Acetonitrile, gradient grade		
Flow rate	1.0 ml/min		
	Time (min)	A (%)	B (%)
Pump program	0	25	75
	7	25	75
	17	10	90
	19	10	90
	20	25	75
	25	25	75

**Tab. 7** Preparative methanol method

Column temperature	RT
Injection volume	15 ml
Injection mode	Main pump
Detection	UV 228 nm/306 nm
Data rate	2 Hz

### Gradient

Eluent (A)	90% methanol/10% water (v/v)				
Eluent (B)	100% methanol, gradient grade				
Eluent (C)	Sample 50 mg/ml CBD oil				
	Time (min)	A (%)	B (%)	C (%)	Flow rate (ml/min)
Pump program	0.00	0	0	100	30
	0.50	0	0	100	30
	0.56	100	0	0	140
	4.50	100	0	0	140
	4.56	0	100	0	140
	8.80	0	100	0	140
	8.86	100	0	0	140
	12	100	0	0	140



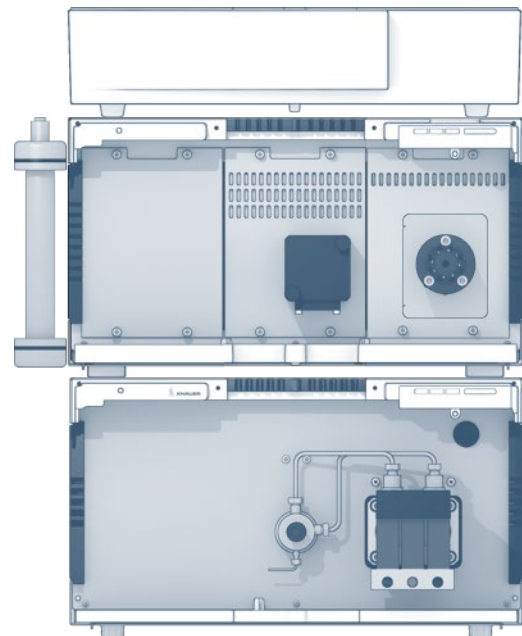
## MATERIALS AND METHODS

**Tab. 8** Analytical system configuration

Instrument	Description	Article No.
Pump	AZURA P 6.1L LPG 10 ml/min, sst	<a href="#">APH34EA</a>
Autosampler	AZURA AS 6.1L, 700 bar	<a href="#">AAA00AA</a>
Detector	AZURA DAD2.1L	<a href="#">ADC01</a>
Puls Damper	High volume, stainless steel	<a href="#">AZZ00NB</a>
Flow cell	Light guide 10mm/10 µl/ 300 bar	<a href="#">AMC38</a>
Thermostat	AZURA CT2.1	<a href="#">ATC00</a>
Column	Eurospher II 100-3 C18P, 150 x 4.6 mm ID	<a href="#">15VE182E2G</a>
Column	Eurospher II 100-10 C18, 150 x 4.6 mm ID	<a href="#">15EE181E2N</a>
Software	ClarityChrom 8.1 - Workstation, autosampler control included	<a href="#">A1670</a>
Software	ClarityChrom 8.1 - PDA extension	<a href="#">A1676</a>

**Tab. 9** Preparative system configuration

Instrument	Description	Article No.
Pump	AZUAR P2.1L, 250 ml/min, sst	<a href="#">APE20LA</a>
Ternary LGP module	AZURA LPG ternary module for pump P 2.1L	<a href="#">AZZ00AB</a>
Assistant	AZURA ASM 2.2L Left: - Middle: UVD 2.1S Right: V 4.1 + 8Mpos, 1/8", sst, 200 bar	<a href="#">AY00163</a> - <a href="#">AVU34AE</a>
Flow cell	3 µl; 1/16"	<a href="#">A4069</a>
Column	Eurospher II 100-10 C18, Column 150x50 mm	<a href="#">15OE181E2N</a>
Software	PurityChrom®Basic	<a href="#">A2650</a>



## REFERENCES

- [38] Bonini, S. A. et al. Cannabis sativa: A comprehensive ethnopharmacological review of a medicinal plant with a long history. *Journal of Ethnopharmacology* 227:300-315 (2018).
- [39] Amin, M. R., Ali, D. W. Pharmacology of Medical Cannabis. *Advances in Experimental Medicine and Biology* 1162:151-165 (2019).
- [40] ElSohly, M. A. et al. Phytochemistry of Cannabis sativa L. *Progress in the Chemistry of Organic Natural Products* 103:1-36 (2017).
- [41] Lafaye, G., Karila, L., Blecha, L., Benyamina, A. Cannabis, cannabinoids, and health. *Dialogues in Clinical Neuroscience* 19(3): 309-316 (2017).
- [42] Pisanti, S. et al. Cannabidiol: State of the art and new challenges for therapeutic applications. *Pharmacology & Therapeutics* 175:133-150 (2017).
- [43] Loxterkamp, L., Monks, K. (C)an(n)alyze: determination of 16 cannabinoids inside flowers, oils and seeds. KNAUER Wissenschaftliche Geräte GmbH (2020).
- [44] Krauke, Y., Monks, K. Purify CBD and other cannabinoids by preparative HPLC. KNAUER Wissenschaftliche Geräte GmbH (2020).

## RELATED KNAUER APPLICATIONS

[VPH0070](#) - (C)an(n)alyze: determination of 16 cannabinoids inside flowers, oils and seeds

[VPH0072](#) - Analyzing cannabis flowers according to the German Pharmacopeia - monograph 2018

[VPH0073](#) - Purify CBD and other cannabinoids by preparative HPLC

# Simplified scale up for sugars with the AZURA® RID 2.1L extended dynamic range option



Juliane Böttcher, Kate Monks; [applications@knauer.net](mailto:applications@knauer.net)  
KNAUER Wissenschaftliche Geräte GmbH, Hegauer Weg 38, 14163 Berlin; [www.knauer.net](http://www.knauer.net)

## SUMMARY

The extended dynamic range (EDR) option for the AZURA® RID 2.1L refractive index detector was investigated with a simple sample consisting of two common sugars. Calibration curves covering the range 700  $\mu$ RIU to 2300  $\mu$ RIU were generated with activated and deactivated EDR. A gain of about 65 % in dynamic range could be demonstrated over this range. Further benefits, such as simplified sample preparation, and improved fractionation possibilities are also discussed.

## INTRODUCTION

The extended dynamic range (EDR) option of the AZURA RID 2.1L enables the linear dynamic range to be broadened in +100 % (-1000  $\mu$ RIU offset) or -100 % (+1000  $\mu$ RIU offset) [1]. This feature enhances the application of this detector for semi-preparative, preparative, and scale-up purposes. For instance, when carrying out overload studies, it is necessary to know how much sample and at which concentration

can be injected on an analytical column. Often these measurements are out of the detector's linear dynamic range. The EDR feature is very useful in this case because it enables the more exact calculation of the amount of sample that can be loaded on a column for purification without the need for additional sample preparation.

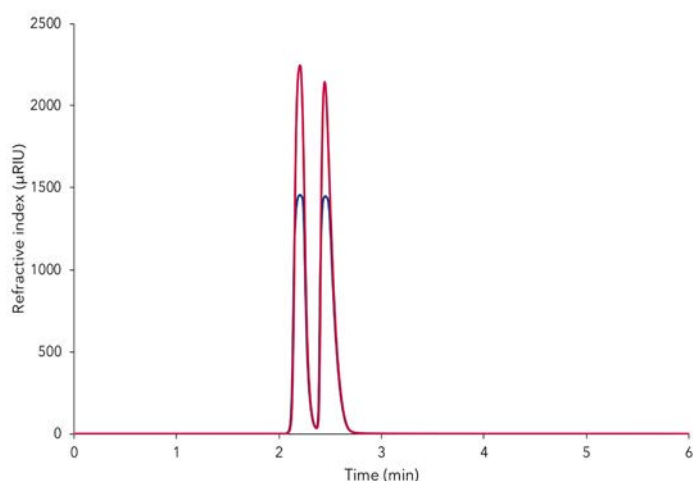


# Simplified scale up for sugars with the AZURA® RID 2.1L extended dynamic range option

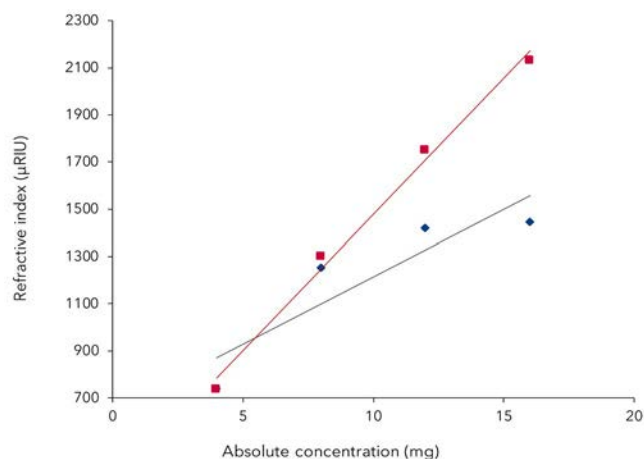
## RESULTS

To investigate the influence of the EDR option a simple method was chosen. A solution with a concentration of 40 mg/mL glucose and saccharose was injected with different volumes (10  $\mu$ L, 20  $\mu$ L, 30  $\mu$ L, 40  $\mu$ L, 50  $\mu$ L, 100  $\mu$ L, 200  $\mu$ L) and measured with and without activated EDR. **Fig 1** shows an overlay of an injection of 50  $\mu$ L with and without extension. The blue trace is without extension, the red trace is detected using the

+100% option. When using the extension, a better resolution was gained as well as a higher and sharper signal was achieved. Now it was possible to measure up to 2.5 mRIU without difficulty. The advantage of the EDR option due to the linearity of calibration is visualized in **Fig 2**. It is shown that when using the extension, better values of linearity and correlation coefficient can be achieved over a wide range.



**Fig. 1** Overlay of an injection with 50  $\mu$ L, blue = without extension, red=with extension (+100%)



**Fig. 2** Linearity of glucose calibration with (red,  $R=0.9924$ ) and without (blue,  $R=0.8087$ ) EDR option

## MATERIALS AND METHOD

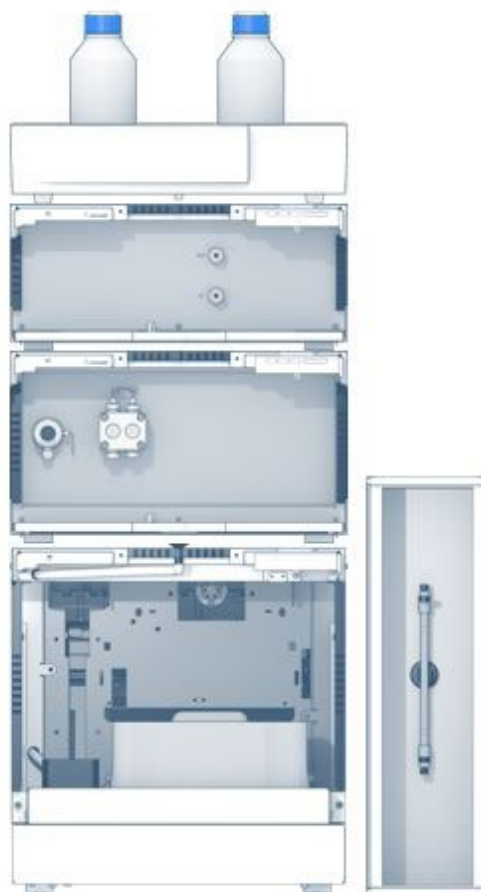
An AZURA® Analytical HPLC Plus system was used for this application. The system consisted of an isocratic AZURA P 6.1L pump, an AZURA AS 6.1L autosampler, an AZURA CT 2.1 column thermostat and an AZURA RID 2.1L refractive index detector. The used column was filled with Eurospher II 100 5 C18A silica. The isocratic method ran at a flow rate of 1.0 mL/min with a 100 % aqueous eluent for 6 minutes. The column thermostat was set to 25 °C and the data rate of the detector to 20 Hz. Different volumes (10 µL, 20 µL, 30 µL, 40 µL, 50 µL, 100 µL, 200 µL) of a solution containing 40 mg/mL of glucose and saccharose were injected.

## CONCLUSION

The EDR feature was shown to prevent the need to dilute samples, which saves time and money and diminishes additional errors during sample preparation. Furthermore, due to an improved peak shape at high sample concentrations, software fractionation algorithms can work more efficiently. Therefore this feature facilitates a more efficient purification. Here, the EDR was used in positive mode (+100 %). For applications with inverted peaks, similar applicative benefits could be achieved by activating the negative mode EDR (-100 %). This was not carried out in this study.

## REFERENCES

[1] [http://www.knauer.net/fileadmin/user\\_upload/produkte/files/Dokumente/detectors/azura/PITTCON\\_REFRACTIVE\\_INDEX\\_DETECTOR\\_KIT\\_2017.pdf](http://www.knauer.net/fileadmin/user_upload/produkte/files/Dokumente/detectors/azura/PITTCON_REFRACTIVE_INDEX_DETECTOR_KIT_2017.pdf)



## ADDITIONAL MATERIALS AND METHODS

Tab. A1 Method parameters

Eluent A	H <sub>2</sub> O <sub>dd</sub>		
Gradient	Isocratic, 100 % A		
Flow rate	1 mL/min	Run time	6 min
Column temperature	25 °C	Injection mode	Partial loop/Full loop
Injection volume	10 µL, 20 µL, 30 µL, 40 µL, 50 µL, 100 µL, 200 µL	Data rate	20 Hz
		Time constant	0.05 sec

Tab. A2 System configuration

Instrument	Description	Article No.
Pump	AZURA P 6.1L, isocratic, 10 mL, SS	<a href="#">APH30EA</a>
Autosampler	AZURA AS 6.1L	<a href="#">AAA00AA</a>
Detector	AZURA RID 2.1L	<a href="#">ADD31</a>
Thermostat	AZURA CT 2.1	<a href="#">A05852</a>
Eluent tray	AZURA E 2.1L	<a href="#">AZC00</a>
Column	Vertex Plus Column, 250x4 mm, Eurospher II 100-5 C18A with precolumn	<a href="#">25WE184E2J</a>
Software	ClarityChrom 6.1.0	<a href="#">A1670-9</a>

## RELATED KNAUER APPLICATIONS

[VFD0160](#) - Determination of sugars and natural sugar substitutes in different matrices

[VFD0161](#) - Determination of sugars in honey using HILIC separation and RI detection

[VFD0155](#) - Semi preparative xylitol purification with dedicated sugar purification system

[VFD0150](#) - Alternative xylitol extraction via hplc purification from fermented biomass

# Column choice based on Tanaka characterization - not all C18 columns are the same

Juliane Böttcher, Mareike Margraf, Kate Monks; [applications@knauer.net](mailto:applications@knauer.net)  
KNAUER Wissenschaftliche Geräte GmbH, Hegauer Weg 38, 14163 Berlin; [www.knauer.net](http://www.knauer.net)

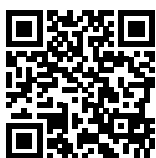
## SUMMARY

Reversed Phase (RP) is with more than 90 % market share by far the most commonly used HPLC mode. The best known and most used surface modification is C18. Although the USP column code (L1) is the same for all C18 phases, there are a lot of differences which must be considered when choosing the right column. C18 always is a good choice for an initial try but one must bear in mind that not all C18 phases have the same separation characteristics. To differentiate between such phases Tanaka plots are extremely useful.

## INTRODUCTION

The Tanaka test is an accepted standard method for the evaluation of performance and selectivity of a reversed phase HPLC column [1]. The Tanaka protocol is based on six variables (hydrophobic retention factor, hydrophobic selectivity, shape selectivity, hydrogen bonding capacity, total ion exchange capacity, acidic ion exchange capacity) reflecting different chromatographic properties. Here we focus on the hydrophobic retention, hydrophobic selectivity and shape selectivity of the following KNAUER C18 phases: Eurospher II C18 (ES II C18), Eurospher II C18 A (ES II C18 A), Eurospher II C18 H (ES II C18 H), Eurospher II C18 P (ES II C18 P), Eurospher I C18 (ES I C18), and

Eurosil Bioselect C18 (EB C18). The hydrogen bonding capacity and ion exchange capacities are not considered here because they are nearly similar for the examined phases. The hydrophobic retention factor (HR) reflects the surface area and surface coverage (ligand density). Hydrophobic selectivity (HS) is a measure of the surface coverage of the phase as the selectivity between alkylbenzenes differentiated by one methylene group is dependent on the ligand density. Shape selectivity (SS) is a dimension which is influenced by the spacing of the ligands and probably also the shape/functionality of the silylating reagent [1].

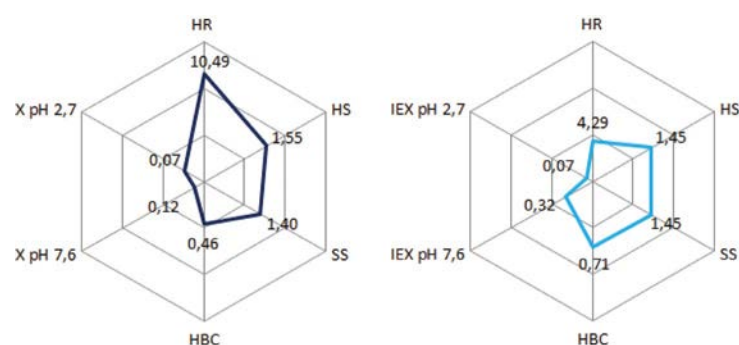


# Column choice based on Tanaka characterization – not all C18 columns are the same

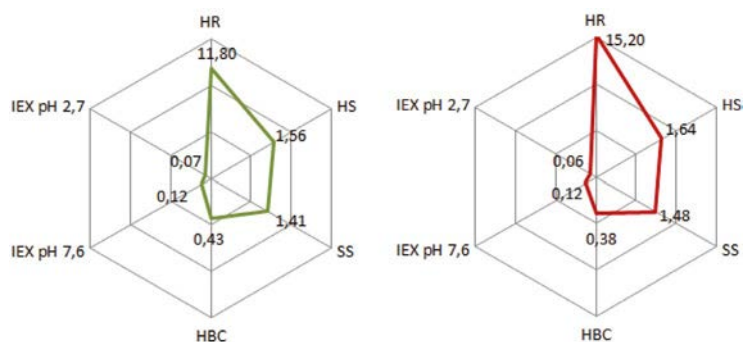
## RESULTS

A hexagonal net diagram was used to display the measured Tanaka parameters as it enables good visual comparison of phases. For this type of diagram measured values are multiplied by certain factors. The measured values without multipliers are shown in **Tab A1** in the additional results section. **Fig 1 to 3** show the Tanaka plots for the tested phases. The values for the ion exchange capacity and hydrogen bonding capacity are quite similar for all and were

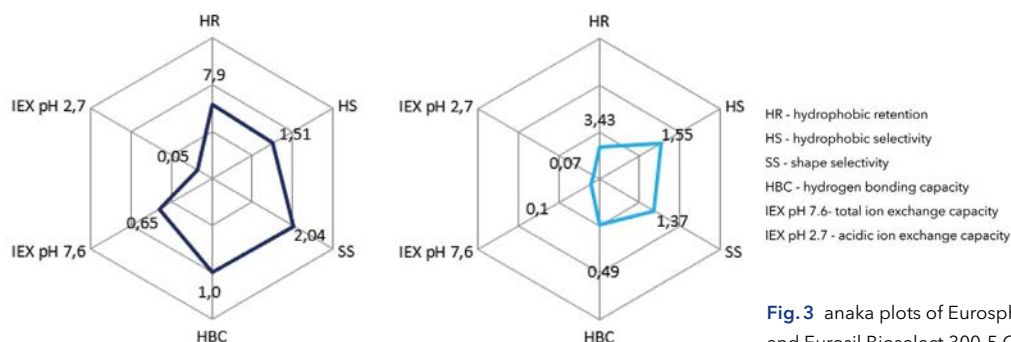
therefore not considered. The biggest difference between the tested phases could be seen when comparing the hydrophobic retention factor (HR) - the higher this value the less polar the modification. Sorting the phases with ascending hydrophobic retention leads to the following order: EB C18 > ES II C18 A > ES I C18 > ES II C18 > ES II C18 H > ES II C18 P. The value for shape selectivity of the Eurospher I phase is slightly deviating. This may be due to an incomplete endcapping.



**Fig. 1** Tanaka Plots of Eurospher II 100-5 C18 (left) and Eurospher 100-5 C18 A (right) T



**Fig. 2** Tanaka plots of Eurospher II 100-5 C18 H (left) and Eurospher II 100-5 C18 P (right)



**Fig. 3** Tanaka plots of Eurospher I 100-5 C18 (left) and Eurosil Bioselect 300-5 C18 (right)

HR - hydrophobic retention  
 HS - hydrophobic selectivity  
 SS - shape selectivity  
 HBC - hydrogen bonding capacity  
 IEX pH 7,6- total ion exchange capacity  
 IEX pH 2,7 - acidic ion exchange capacity



## MATERIALS AND METHODS

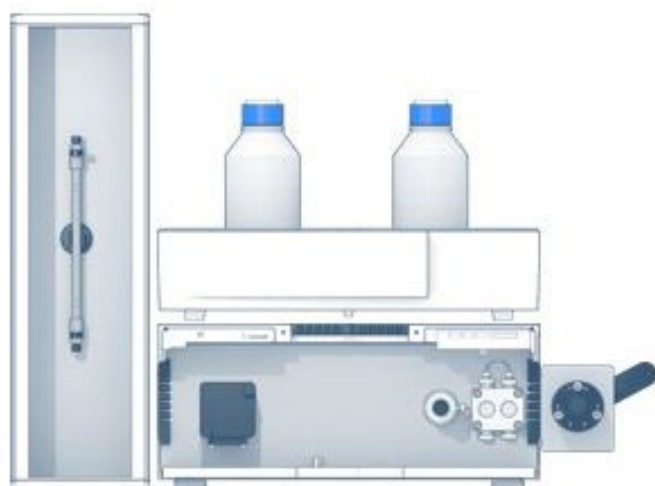
For the determination of the Tanaka parameters the KNAUER AZURA® Educational System was used. The method ran isocratically with a mobile phase composition of methanol:water 80:20 (v/v). The column thermostat AZURA® CT 2.1 was set to 30 °C and the UV detector was set to 254 nm. All used columns had a dimension of 150 x 4 mm ID and were filled with the following silica: Eurospher II 100-5 C18, Eurospher II 100-5 C18 A, Eurospher II 100-5 C18 H, Eurospher II 100 5 C18 P, Eurospher I 100-5 C18 and Eurosil Bioselect 300-5 C18. This method was used only for determination of HR, HS and SS. Detailed method parameters for HBC and IEX are attached in the additional materials and methods section (**Tab A3 & A4**).

## CONCLUSION

The results obtained from the Tanaka test comparison can be used to assist in the choice of the most appropriate column for a given separation task. It is also important to know as much as possible about the chemical properties of the analyte. An analyte that is soluble only in a solvent with a high organic amount will have slightly or no retention on a C18 A phase. However, the C18 A phase can be operated with 100% aqueous eluent without destroying the stationary phase. Inversely, a very polar analyte might have less retention on the C18 P or C18 H modification. However, due to their high carbon content they provide a high pH stability in an extended pH range. Furthermore, if the molecular weight of the analyte is above 2000 Da, a pore size of with 100 Å may be insufficient, making the so Eurosil Bioselect with a pore size of 300 Å the better choice. The KNAUER column portfolio offers classical and special C18 phases, making it easy to find the most appropriate column for a given application task.

## REFERENCES

[1] <http://www.chromatographyonline.com/column-selection-reversed-phase-hplc>



## ADDITIONAL RESULTS

**Tab. A1** Measured Tanaka values without multipliers

Column	HR	HS	SS	HBC	IEC pH 7.6	IEC pH 2.7
Eurospher II 100-5 C18	10.94	1.55	1.40	0.46	0.12	0.07
Eurospher II 100-5 C18 P	15.20	1.64	1.48	0.38	0.12	0.06
Eurospher II 100-5 C18 H	11.80	1.56	1.41	0.43	0.12	0.07
Eurospher II 100-5 C18 A	4.29	1.45	1.45	0.71	0.32	0.07
Eurospher I 100-5 C18	7.90	1.51	2.04	1.00	0.65	0.05
Eurosil Bioselect 300-5 C18	3.43	1.55	1.37	0.49	0.10	0.07

## ADDITIONAL MATERIALS AND METHODS

**Tab. A2** Method parameters (HR, HS, SS)

Eluent	Methanol: Water 80:20 (v/v)		
Gradient	isocratic		
Flow rate	1 mL/min	Run time	20 min
Column temperature	30 °C	Injection mode	Full loop
Injection volume	10 µL	Data rate	20 Hz
Detection	254 nm	Time constant	0.05 s

**Tab. A3** Method parameters (HBC)

Eluent	Methanol: Water 30:70 (v/v)		
Gradient	isocratic		
Flow rate	1 mL/min	Run time	20 min
Column temperature	30 °C	Injection mode	Full loop
Injection volume	10 µL	Data rate	20 Hz
Detection	254 nm	Time constant	0.05 s

**Tab. A4** Method parameters (IEX)

Eluent	Methanol: 0.02 M phosphate buffer pH 7.6 30:70 (v/v) Methanol: 0.02 M phosphate buffer pH 2.7 30:70 (v/v)		
Gradient	isocratic		
Flow rate	1 mL/min	Run time	20 min
Column temperature	30 °C	Injection mode	Full loop
Injection volume	10 µL	Data rate	20 Hz
Detection	254 nm	Time constant	0.05 s

**Tab. A5** System configuration & data

Instrument	Description	Article No.
System	AZURA® Educational System (pump, detector, manual injection valve, ClarityChrom 7.2)	<a href="#">671101100</a>
Column	Eurospher II 100-5 C18 Eurospher II 100-5 C18 A Eurospher II 100-5 C18 H Eurospher II 100-5 C18 P Eurospher I 100-5 C18 Eurosil Bioselect 300-5 C18 All: Vertex Plus Column 150 x 4 mm ID	<a href="#">15DE181E2J</a> <a href="#">15DE184E2J</a> <a href="#">15DE185E2J</a> <a href="#">15DE182E2J</a> <a href="#">15DE181ESJ</a> <a href="#">15DK181EBJ</a>
Thermostat	AZURA® CT 2.1	<a href="#">A05852</a>

# Quantification of caffeine with the AZURA® Educational system and Mobile Control Software

Juliane Böttcher, Mareike Margraf, Kate Monks; applications@knauer.net  
KNAUER Wissenschaftliche Geräte GmbH, Hegauer Weg 38, 14163 Berlin; www.knauer.net



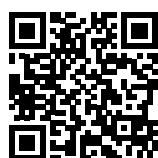
## SUMMARY

The AZURA® Educational system allows an easy and fast implementation of liquid chromatography (HPLC, high pressure liquid chromatography) and promotes a deeper understanding of this separation method. A simple example is given describing the determination of a sample containing caffeine and paracetamol.

## INTRODUCTION

Caffeine and paracetamol are widely-used pharmaceutical components. Both substances are present as ingredients in many analgesics. Hence, they are often determined simultaneously in routine analysis. Theophylline, a substance chemically closely related to caffeine, is used to serve as an internal standard. [1] To analyze the components, the KNAUER HPLC Educational system is used providing isocratic elution

HPLC in combination with UV detection. The samples are injected via a manual injection valve. Based on the KNAUER AZURA Compact series, this system layout represents an easy and convenient solution for the current application. The determination of a sample containing caffeine and paracetamol is a typical example from applied research for the implementation of the KNAUER HPLC Educational system.

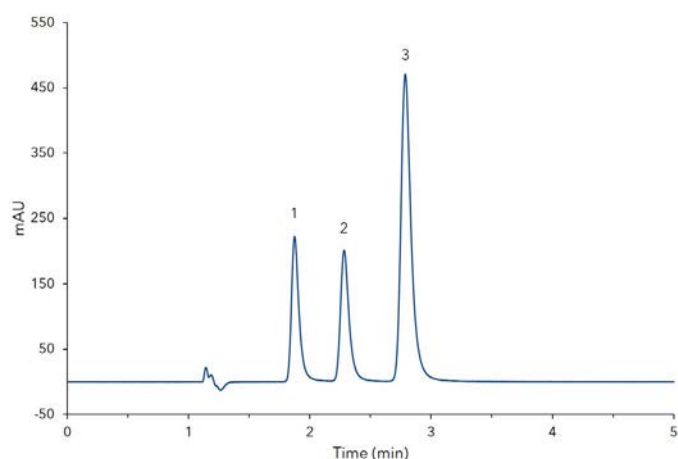


# Quantification of caffeine with the AZURA® Educational system and Mobile Control Software

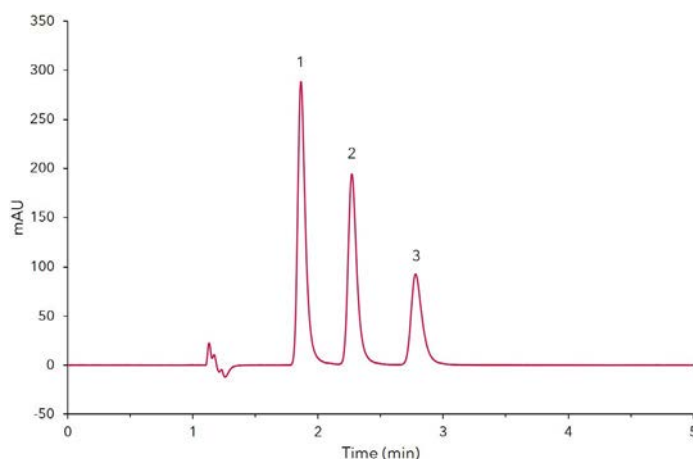
## RESULTS

At first, stock solutions are prepared from caffeine, paracetamol and theophylline. The initial weight of the substances should be about 100 mg. However, it is important to note the exact sample weight to obtain accurate results for the quantitative analysis. All standards were dissolved and sonicated to yield stock solutions of approximately 10 mg/mL. To identify the individual substances directly by HPLC, the substances are diluted with water (Tab A1, Additional Materials and Methods). Secondly, a single calibration solution is prepared from the caffeine and paracetamol stock solution. For this purpose, 50  $\mu$ L of the caffeine stock solution and 50  $\mu$ L of the paracetamol stock solution are combined and diluted with water to a final volume of 5 mL. For the current application, five dilution levels (Tab A2, Additional Materials and Methods) have been prepared. Furthermore, 100  $\mu$ L of the theophylline stock solution are diluted

with water to a final volume of 1 mL. Subsequently, a volume of 20  $\mu$ L of this solution is added to standard 1 - 5. Fig 1 shows the chromatogram of the calibration standard at level 4 (60 $\mu$ g/mL). The peaks are baseline separated in less than 5 minutes. Fig 2 shows the measurement of an analgesic sample. Therefore, analgesic tablets containing paracetamol and caffeine were chosen. The internal standard theophylline was added according to the preparation of calibration solutions. A concentration of 53 mg caffeine was calculated for the sample. This amount refers to the weight of one tablet. Relating to the package insert, the analgesic should contain 50 mg caffeine per tablet. The deviation of the measured and proclaimed value might result from differing calibrations and/or measurement errors. For the detailed preparation of standards, sample and calibration please see application VSP0018.



**Fig. 1** Chromatogram of standard solution 4, 1) paracetamol, 2) theophylline (IS), 3) caffeine



**Fig. 2** Chromatogram of analgesic sample, 1) paracetamol, 2) theophylline (IS), 3) caffeine

## MATERIALS AND METHODS

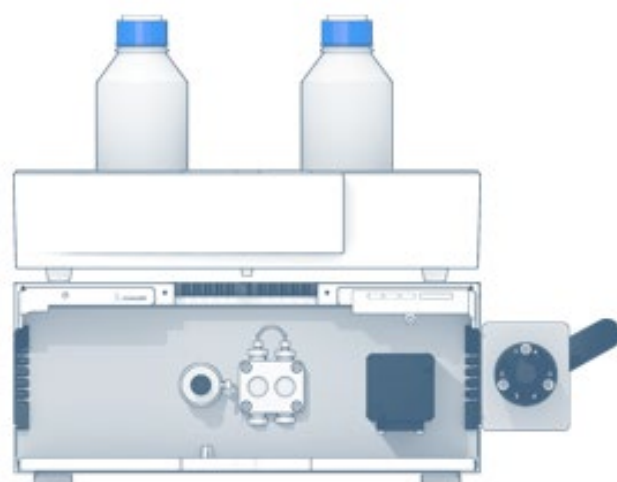
For the determination of caffeine and paracetamol the AZURA Educational system was used, which combines a P 4.1S pump, an UVD 2.1S and a manual injection valve in just one AZURA assistant. The flow rate was set to 0.8 ml/min at ambient temperature. The wavelength was set to 273 nm with a data rate of 20 Hz and a time constant of 0.05 s. 10  $\mu$ L of the standards and samples were injected. The isocratic method ran for 5 minutes with a mixture of methanol and water 40:60 (v/v). The column in a dimension 125 x 4 mm ID with precolumn was filled with Eurospher II 100-5 C18 silica. For the data acquisition the Mobile Control Chrom software was used.

## CONCLUSION

The KNAUER HPLC Educational System provides both, a qualitative and quantitative analysis of caffeine from different chemical probes. The system is compact, very simple to operate and can be ideally used for practical training courses. The Mobile Control Chrom is an intuitive and cost-effective software solution for controlling and monitoring your AZURA devices and systems. In addition, you can acquire data from AZURA detectors allowing simple measurements.

## REFERENCES

[1] Entry: internal standard. In: IUPAC Compendium of Chemical Terminology (the "Gold Book").  
doi:10.1351/goldbook.I03108.



## ADDITIONAL RESULTS

**Tab. A1** Initial weight and dilution of stock solutions

Substance	Initial weight (mg)	Final conc. stock solution (mg/mL)	Final conc. diluted solution (µg/mL)
Caffeine	100.0	10.0	100.0
Theophylline	99.3	9.9	99.3
Paracetamol	98.7	9.9	98.7

**Tab. A2** Caffeine standards 1 to 5

Caffeine standard	Projected caffeine conc. (V = 1 mL) (µg/mL)	Actual caffeine conc. (V = 1.02 mL) (µg/mL)
1	5	4.9
2	20	19.6
3	40	39.2
4	60	58.7
5	80	78.4

## ADDITIONAL MATERIALS AND METHODS

**Tab. A3** Method parameters

Eluent	Methanol:Water 40:60 (v/v)		
Gradient	isocratic		
Flow rate	0.8 mL/min	System pressure	approx. 115 bar
Column temperature	RT	Run time	5 min
Injection volume	10 µL	Injection mode	Full loop
Detection wavelength	273 nm	Data rate	20 Hz
		Time constant	0.05 s

**Tab. A4** System configuration & data

Instrument	Description	Article No.
System	AZURA® Educational system	<a href="#">671101100</a>
Column	Eurospher II 100-5 C18, Vertex Plus 125 x 4 mm ID with precolumn	<a href="#">12WE181E2J</a>
Software	Mobile Control Chrom	<a href="#">A9608</a>



[AZURA® Educational system](#)

## RELATED KNAUER APPLICATIONS

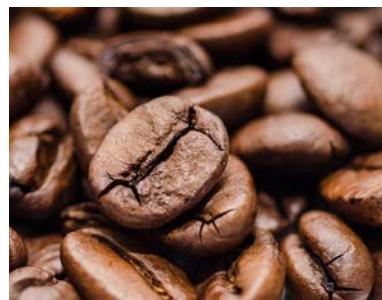
[VSP0017](#) - Quantification of caffeine with the AZURA® Educational system and ClarityChrom software

[VSP0018](#) - Preparation of calibration and samples for the quantification of caffeine with the AZURA® Educational system

[VSP0019](#) - HPLC Basics - principles and parameters

# Quantification of caffeine with the AZURA® Educational system and ClarityChrom software

Juliane Böttcher, Mareike Margraf, Kate Monks; applications@knauer.net  
KNAUER Wissenschaftliche Geräte GmbH, Hegauer Weg 38, 14163 Berlin; www.knauer.net



## SUMMARY

The AZURA® HPLC Educational System allows an easy and fast introduction to liquid chromatography (HPLC, high pressure liquid chromatography) and promotes a deeper understanding of this separation method. A simple example is given describing the determination of a sample containing caffeine, paracetamol and theophylline.

## INTRODUCTION

Caffeine and paracetamol are widely-used pharmaceutical components. Both substances are present as ingredients in many analgesics. Hence, they are often determined simultaneously in routine analysis such as quality control. Theophylline, a substance chemically closely related to caffeine, is used to serve as an internal standard. [1] To analyze these three components, the AZURA Educational System was used providing

isocratic elution HPLC in combination with UV detection. The samples were injected via a manual injection valve. Based on the KNAUER AZURA Compact series, this system layout represents an easy and convenient solution for the current application. ClarityChrom is an easy-to-use Chromatography Data System for workstations. The Educational System license is exclusively bundled with the AZURA Educational System.

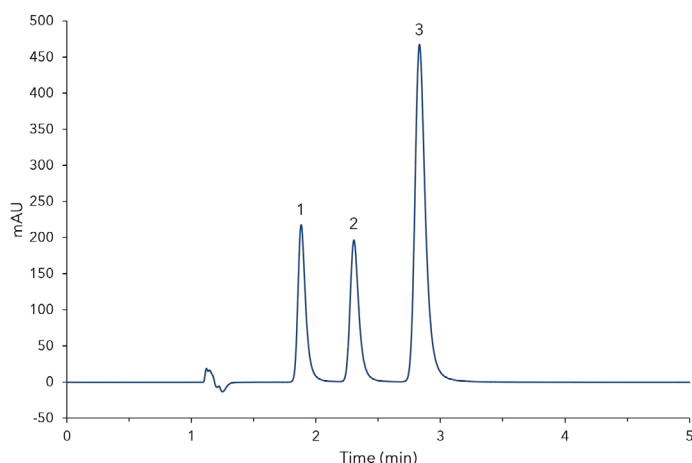


# Quantification of caffeine with the AZURA® Educational system and ClarityChrom software

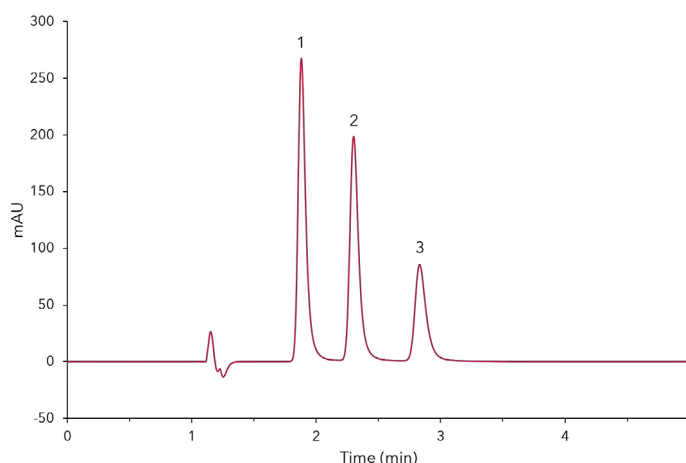
## RESULTS

At first, stock solutions are prepared from caffeine, paracetamol and theophylline. The initial weight of the substances should be about 100 mg. However, it is important to note the exact sample weight to obtain accurate results for the quantitative analysis. All standards were dissolved and sonicated to yield stock solutions of approximately 10 mg/mL. To identify the individual substances directly by HPLC, the substances are diluted with water (Table 1, Additional Materials and Methods). Secondly, a single calibration solution is prepared from the caffeine and paracetamol stock solution. For this purpose, 50  $\mu$ L of the caffeine stock solution and 50  $\mu$ L of the paracetamol stock solution are combined and diluted with water to a final volume of 5 ml. For the current application, five dilution levels (Tab. 2, Additional Materials and Methods) have been prepared. Furthermore, 100  $\mu$ L of the theophylline stock solution are diluted

with water to a final volume of 1 mL. Subsequently, a volume of 20  $\mu$ L of this solution is added to standard 1 - 5. Fig 1 shows the chromatogram of the calibration standard at level 4 (60 $\mu$ g/mL). The peaks are baseline separated in less than 5 minutes. Fig 2 shows the measurement of an analgesic sample. Therefore, analgesic tablets containing paracetamol and caffeine were chosen. The internal standard theophylline was added to the sample according to the preparation of calibration solutions. A concentration of 53 mg caffeine was calculated for the sample. This amount refers to the weight of one tablet. Relating to the package insert, the analgesic should contain 50 mg caffeine per tablet. The deviation of the measured and proclaimed value might result from differing calibrations and/or measurement errors. For the detailed preparation of standards, sample and calibration please see application VSP0018.



**Fig. 1** Chromatogram of standard solution 4, 1) paracetamol, 2) theophylline (IS), 3) caffeine



**Fig. 2** Chromatogram of analgesic sample, 1) paracetamol, 2) theophylline (IS), 3) caffeine



## MATERIALS AND METHODS

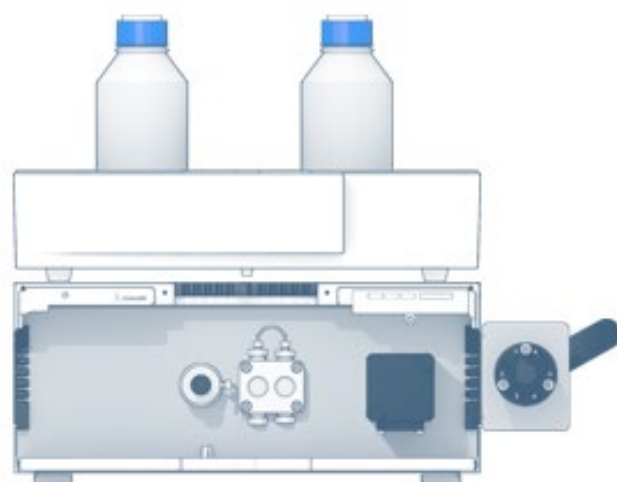
For the determination of caffeine and paracetamol the AZURA® Educational system was used, which combines a P 4.1S pump, an UVD 2.1S and a manual injection valve in just one AZURA assistant. The flow rate was set to 0.8 mL/min at ambient temperature. The wavelength was set to 273 nm with a data rate of 20 Hz and a time constant of 0.05 s. 10 µL of the standards and samples were injected. The isocratic method ran for 5 minutes with a mixture of methanol and water 40:60 (v/v). The column in a dimension 125 x 4 mm ID with precolumn was filled with Eurospher II 100-5 C18 silica. For the data acquisition the ClarityChrom software was used.

## CONCLUSION

The AZURA HPLC Educational System provides both, a qualitative and quantitative analysis of caffeine from different chemical samples. The system is compact, very simple to operate and can be ideally used for practical training courses. The chromatography data system ClarityChrom offers an intuitive system configuration, control and the evaluation of data. More detailed information on hardware and software is available by videos and manuals which will be delivered with the system. The AZURA Educational system video tutorials are available on our website.

## REFERENCES

[2] Entry: internal standard. In: IUPAC Compendium of Chemical Terminology (the "Gold Book"). doi:10.1351/goldbook.i03108.



## ADDITIONAL RESULTS

**Tab. A1** Initial weight and dilution of stock solutions

Substance	Initial weight (mg)	Final conc. stock solution (mg/mL)	Final conc. diluted solution (µg/mL)
Caffeine	100.0	10.0	100.0
Theophylline	99.3	9.9	99.3
Paracetamol	98.7	9.9	98.7

**Tab. A2** Caffeine standards 1 to 5

Caffeine standard	Projected caffeine conc.(V = 1 mL) (µg/mL)	Actual caffeine conc. (V = 1.02 mL) (µg/mL)
1	5	4.9
2	20	19.6
3	40	39.2
4	60	58.7
5	80	78.4

## ADDITIONAL MATERIALS AND METHODS

**Tab. A3** Method parameters

Eluent	Methanol:Water 40:60 (v/v)		
Gradient	isocratic		
Flow rate	0.8 mL/min	System pressure	approx. 115 bar
Column temperature	RT	Run time	5 min
Injection volume	10 µL	Injection mode	Full loop
Detection wavelength	273 nm	Data rate	20 Hz
		Time constant	0.05 s

**Tab. A4** System configuration & data

Instrument	Description	Article No.
System	AZURA® Educational system	<a href="#">671101100</a>
Column	Eurospher II 100-5 C18, Vertex Plus 125 x 4 mm ID with precolumn	<a href="#">12WE181E2J</a>
Software	ClarityChrom® 7.2 - Educational License	<a href="#">A1672-11</a>



[AZURA® Educational system](#)

## RELATED KNAUER APPLICATIONS

[VSP0016](#) - Quantification of caffeine with the AZURA® Educational system and Mobile Control Software

[VSP0018](#) - Preparation of calibration and samples for the quantification of caffeine with the AZURA® Educational system

[VSP0019](#) - HPLC Basics - principles and parameters

# Preparation of calibration and samples for the quantification of caffeine with the AZURA® Educational system

Juliane Böttcher, Mareike Margraf, Kate Monks; applications@knauer.net  
KNAUER Wissenschaftliche Geräte GmbH, Hegauer Weg 38, 14163 Berlin; www.knauer.net



## SUMMARY

The AZURA® Educational system allows an easy and fast implementation of liquid chromatography (HPLC, high pressure liquid chromatography) and promotes a deeper understanding of this separation method. A simple example is given describing the determination of a sample containing caffeine and paracetamol.

## INTRODUCTION

The following descriptions are necessary to perform the measurements shown in KNAUER application notes VSP0016 and VSP0017. A detailed procedure for the preparation, dilution, and calculation of

standard solutions used for calibration and an analgesic sample will be executed here. This guidance is suitable for data acquisition with either Mobile Control or ClarityChrom.



# Preparation of calibration and samples for the quantification of caffeine with the AZURA® Educational system

## CALIBRATION PREPARATION

At first, individual stock solutions were prepared from caffeine, paracetamol, and theophylline. The initial weight of the substances should be about 100 mg (NOTE: for subsequent quantification it was important to record the exact initial weight). The substances were dissolved in 10 mL of methanol and sonicated to yield stock solutions of approx. 10 mg/mL. To identify the individual substances directly by HPLC, the substances were then diluted 1:100 with water. **Tab. 1** shows exemplary initial weights and dilutions of the stock solutions.

Secondly, a single calibration solution was prepared from the caffeine and paracetamol stock solutions. For this purpose, 50 µL of the caffeine stock solution and 50 µL of the paracetamol stock solution were combined and diluted with water to a final volume of 5 mL (1:100 dilution). Thus, each individual substance had a concentration of approx. 100 µg/mL. For HPLC

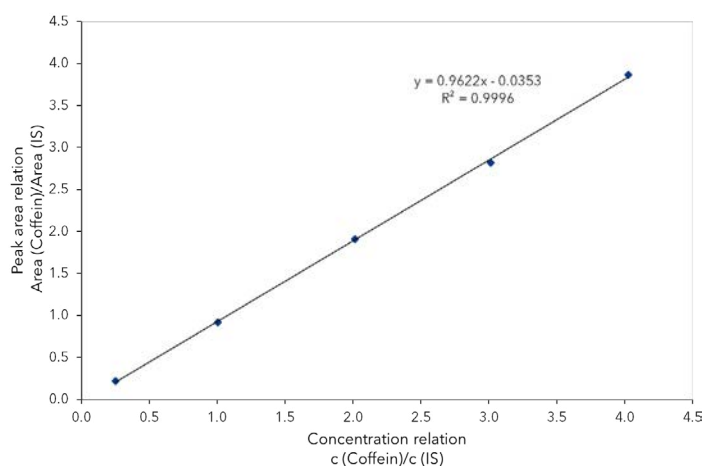
analysis, the dilution levels of the calibration solution should cover a range from 5-80 µg/mL. To ensure a correct measurement, at least four different dilution levels should be achieved. In this application, five dilution levels were prepared. The concentration of the calibration levels is shown in **Tab. 2**. The corresponding solutions were named standard 1 to 5. An additional calibration solution of the internal standard becomes necessary for quantitative HPLC analysis. For this purpose, 100 µL of the theophylline stock solution were diluted with water to a final volume of 1.00 mL (1:10 dilution, concentration approx. 1 mg/mL). Subsequently, a volume of 20 µL (final concentration approx. 20 µg/mL) of this solution was added to the standard solutions 1 to 5. Since, by the addition of the internal standard the final volume increased by 20 µL, it was important to calculate the concentration of caffeine in the final volume of 1.02 mL (**column 3, Tab. 2**).

**Tab. 1** Initial weight and dilution of stock solutions

Substance	Initial weight (mg)	Final conc. stock solution (mg/mL)	Final conc. diluted solution (µg/mL)
Caffeine	99.3	9.9	99.3
Theophylline	113.2	11.3	113.2
Paracetamol	107.7	10.7	107.7

**Tab. 2** Caffeine standards 1 to 5

Caffeine standard	Projected caffeine conc. (V = 1 mL) (µg/mL)	Actual caffeine conc. (V = 1.02 mL) (µg/mL)
1	5	4.9
2	20	19.5
3	40	38.9
4	60	58.4
5	80	77.8



**Fig. 1** Calculated ISTD calibration curve of caffeine (Mobile Control)

## CALIBRATION CALCULATION SAMPLE PREPARATION

To calibrate the system, the standard solutions were injected into the system and the peak areas were analyzed. Each standard solution was injected three times to ensure sufficient data acquisition.

Depending on which software is used for the data acquisition, the calculation of calibration is different. The ClarityChrom HPLC software correlates the peak areas of the standard solutions and the peak area of the internal standard for each concentration (method: ISTD calibration curve). When Mobile Control Chrom is used, the calibration curve is generated with the help of e.g. MS Office Excel (exemplary ISTD calibration curve see **Fig. 1**). With the Mobile Control Data Viewer the peak areas can be displayed but a calibration cannot be done automatically.

A solid sample (tablet) of an analgesic product was crushed with a mortar to fine powder. Then approximately 100 mg of the homogenised sample were weighed and the weight was registered (important for quantitative analysis). The sample was then dissolved in 10 mL methanol. Thereafter, the sample was filtered through a syringe filter with a pore size of 0.45  $\mu\text{m}$ . Subsequently, the filtered sample was diluted 1:100 with water. 1 mL of this solution was transferred to an appropriate vessel (vial).

Similarly, to the standard solutions, the internal standard theophylline (20  $\mu\text{L}$ , final concentration approx. 20  $\mu\text{g/mL}$ ) was added to the sample solution. After proper mixing of the sample solution, it was ready for HPLC analysis.

### INFOBOX : INTERNAL STANDARDS

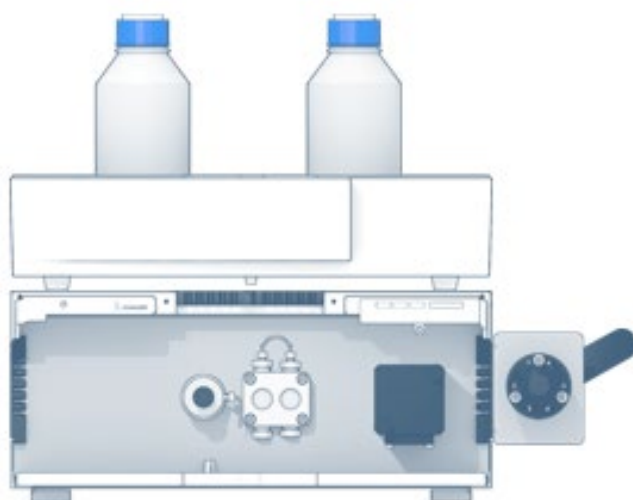
In chromatography an internal standard represents a compound which is added to a sample in a known concentration. It is used to facilitate the qualitative identification and/or quantitative determination of the sample components. An internal standard must be very similar but not identical to the chemical species of the analyte. Moreover, it should not occur in the investigated sample. [1]

## MATERIALS AND METHODS

The analytical parameters for determination are described in KNAUER application notes VSP0016 and VSP0017.

## REFERENCES

[1] Entry: internal standard. In: IUPAC Compendium of Chemical Terminology (the "Gold Book"). doi:10.1351/goldbook.i03108.



## ADDITIONAL MATERIALS AND METHODS

Tab. A1 Method parameters

Eluent	Methanol:Water 40:60 (v/v)		
Gradient	isocratic		
Flow rate	0.8 mL/min	System pressure	approx. 115 bar
Column temperature	RT	Run time	5 min
Injection volume	10 µL	Injection mode	Full loop
Detection wavelength	273 nm	Data rate	20 Hz
		Time constant	0.05 s

Tab. A2 System configuration & data

Instrument	Description	Article No.
System	AZURA® Educational system	<a href="#">671101100</a>
Column	Eurospher II 100-5 C18, Vertex Plus 125 x 4 mm ID with precolumn	<a href="#">12WE181E2J</a>
Software	ClarityChrom 7.2 - Educational License Mobile Control Chrom	<a href="#">A1672-11</a> <a href="#">A9608</a>



[AZURA® Educational system](#)

## RELATED KNAUER APPLICATIONS

[VSP0016](#) - Quantification of caffeine with the AZURA® Educational system and Mobile Control Software

[VSP0017](#) - Quantification of caffeine with the AZURA® Educational system and ClarityChrom software

[VSP0019](#) - HPLC Basics - principles and parameters

# HPLC Basics - principles and parameters

Juliane Böttcher, Mareike Margraf, Kate Monks; [applications@knauer.net](mailto:applications@knauer.net)  
KNAUER Wissenschaftliche Geräte GmbH, Hegauer Weg 38, 14163 Berlin; [www.knauer.net](http://www.knauer.net)

## SUMMARY

Liquid chromatography is a well-established technique for the separation of substances. High performance liquid chromatography (HPLC) is a suitable method for the analysis of a wide range of application areas. Here, we describe the principle of HPLC and introduce to the most important components in an HPLC system and the factors that determine the success of a measurement.

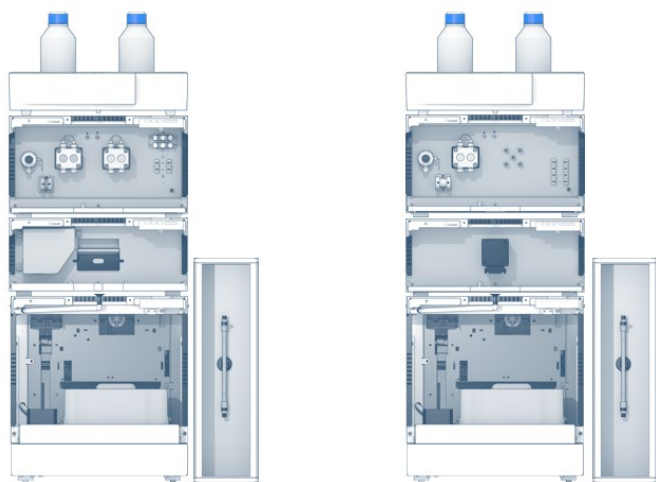


# HPLC Basics - principles and parameters

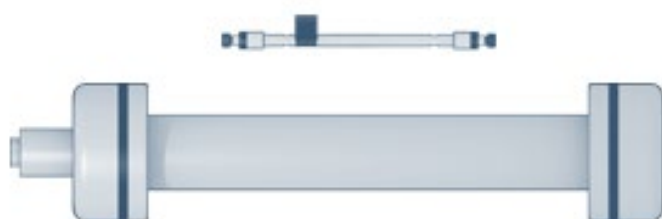
## PRINCIPLE OF HPLC

The separation principle of HPLC is based on the distribution of the analyte (sample) between a mobile phase (eluent) and a stationary phase (packing material of the column). Depending on the chemical structure of the analyte, the molecules are retarded while passing the stationary phase. The specific intermolecular interactions between the molecules of a sample and the packing material define their time "on-column". Hence, different constituents of a sample are eluted at different times. Thereby, the separation of the sample ingredients is achieved. A detection unit (e.g. UV detector) recognizes the analytes after leaving the column. The signals are converted and recorded by

a data management system (computer software) and then shown in a chromatogram. After passing the detector unit, the mobile phase can be subjected to additional detector units, a fraction collection unit or to the waste. In general, a HPLC system contains the following modules: a solvent reservoir, a pump, an injection valve, a column, a detector unit and a data processing unit (**Fig. 1**). The solvent (eluent) is delivered by the pump at high pressure and constant speed through the system. To keep the drift and noise of the detector signal as low as possible, a constant and pulseless flow from the pump is crucial. The analyte (sample) is provided to the eluent by the injection valve.



**Fig. 2** Analytical HPG (left) and LPG (right) system configuration with auto-sampler and column thermostat



**Fig. 3** Analytical and preparative column



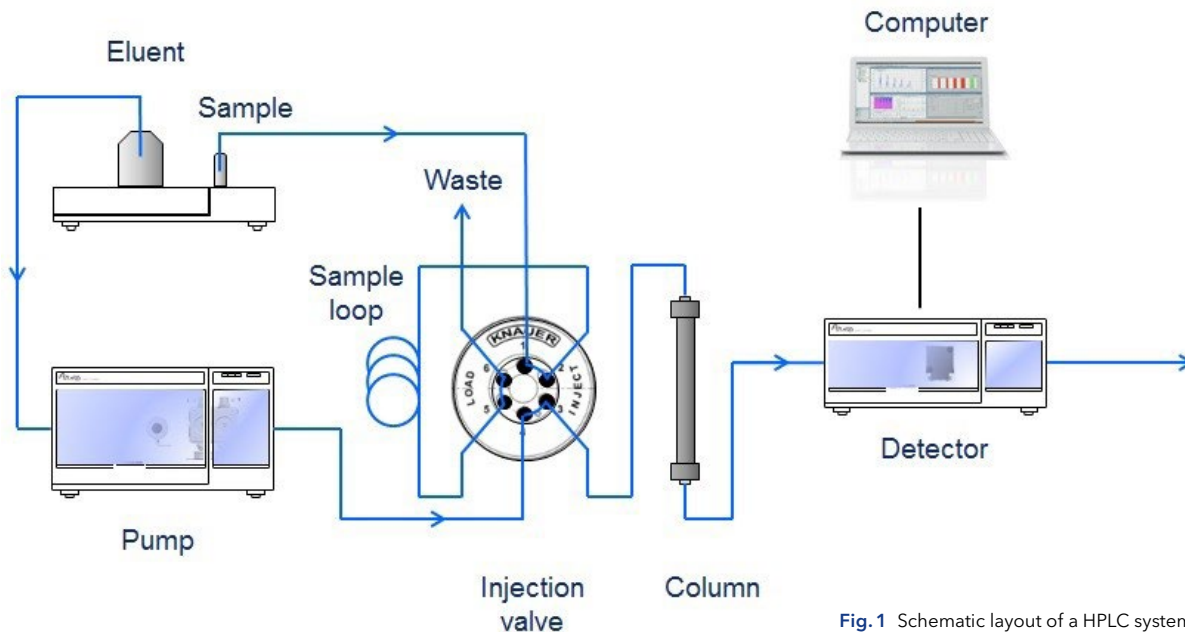
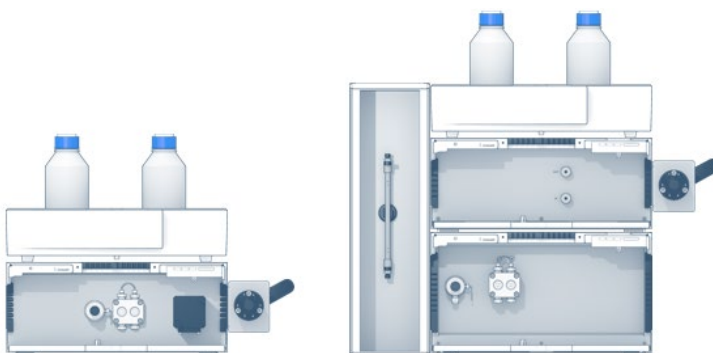


Fig. 1 Schematic layout of a HPLC system

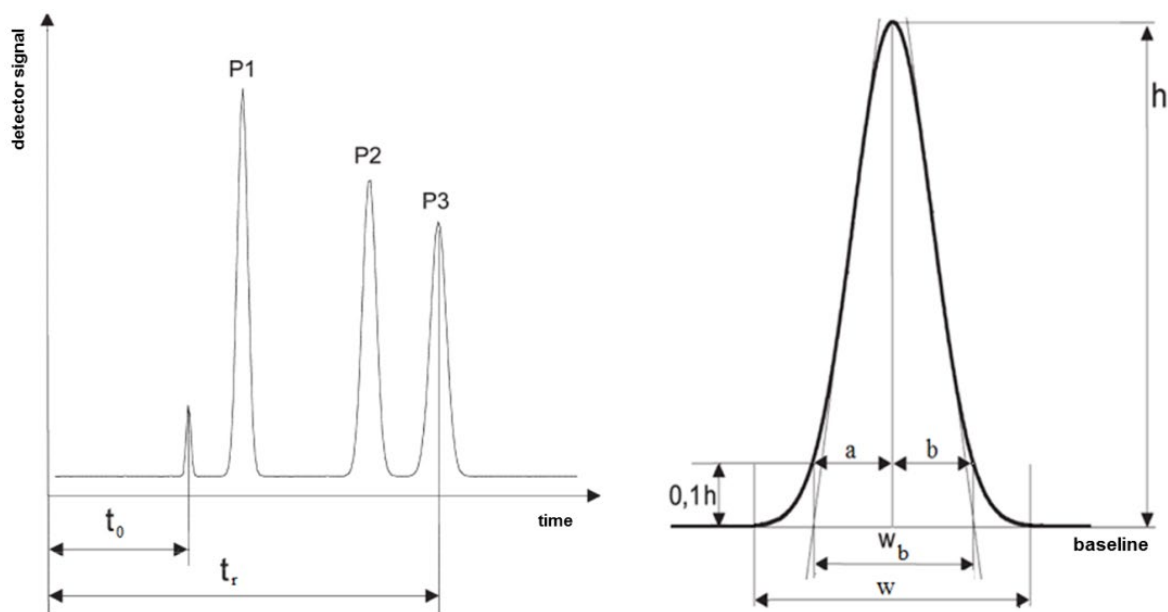
<p><b>Gradient vs. isocratic</b></p>	<p>Depending on the composition of the mobile phase, two different modes are generally applicable. If the makeup of the mobile phase remains constant during the separation process, the HPLC system is defined as an isocratic elution system. When the composition of the mobile phase is changed during separation, the HPLC system is defined as a gradient elution system. [1,2] Using a gradient system, two different techniques are available: a low-pressure gradient (LPG) and a high-pressure gradient (HPG). A low-pressure gradient means that the mixing of the solvents is carried out upstream of the pump (suction side). In a high-pressure gradient system, the different solvents are supplied by individual pumps and mixed after the pumps (discharge side). [1] <b>Fig. 2</b> shows exemplary system configurations for a LPG and a HPG gradient mode.</p>
<p><b>Column</b></p>	<p>The column represents the heart of any HPLC system. It is responsible for the adequate separation of the sample ingredients. The separation efficiency correlates with the column inner diameter, the length of the column and the type and particle size of the column packing material. Depending on the desired application, numerous HPLC columns are commercially available. Different packing materials support different separation mechanisms - common are materials for normal-phase, reversed-phase, size exclusion, ion exchange, affinity, chiral, or hydrophilic interaction HPLC. [1] In <b>Fig. 3</b> an analytical and a preparative column are shown.</p>
<p><b>Detector</b></p>	<p>The task of the detector unit is to register the time and amount of a substance which is eluted from the column. The detector perceives the change in the composition of the eluent and converts this information into an electrical signal which is evaluated by the aid of a computer. [1] A variety of detectors is available depending on the structural characteristics of the analyte. Common detector units are refractometric, UV/VIS, electrochemical and fluorescence detectors. <b>Fig. 4</b> shows two isocratic system configurations with different detectors.</p>

Fig. 4 Isocratic system configuration with a single wavelength UV-detector (left) and a refractive index detector (right)



## REFERENCES

- [2] Meyer, V. R.: Practical High Performance Liquid Chromatography. 5. Aufl. Chichester: WILEY, 2010.
- [3] Böcker, J.: Chromatographie. Würzburg: Vogel Buchverlag, 1997.
- [4] Kromidas, S.; Kuss, H.-J.: Chromatogramme richtig integrieren und bewerten: Ein Praxishandbuch für die HPLC und GC. Weinheim: WILEY-VCH Verlag GmbH & Co. KGaA, 2008.
- [5] Dolan, J. W.: Peak Tailing and Resolution. LC GC Europe, 2002.



#### Chromatographic parameters

The separated analytes which are transported by the mobile phase are recorded as signal peaks by the detector unit. The total amount of all peaks is called chromatogram. Each individual peak provides qualitative and quantitative information of the analyte. Qualitative information is given by the peak itself (e.g.: shape, intensity of the signal, time of appearance in the chromatogram). In addition, the area of a peak is proportional to the concentration of the substance. Hence, the chromatography data management software can calculate the concentration of the sample by integration. This provides quantitative information. Ideally the peaks are recorded as a Gaussian bell-shaped curve. A schematic example is illustrated in **Fig. 5**. The basic parameters of a chromatographic separation are discussed below.

#### Delay time ( $t_0$ )

The delay time refers to the time which is required for a non-retarded compound to be transported from the injection site to the detector unit (where the compound is recorded). During this time, all sample molecules are exclusively located in the mobile phase. In general, all sample molecules share the same delay time. The separation is caused by differing adherence of the substances with the stationary phase.

#### Retention time ( $t_r$ )

The retention time refers to the time which is required for a compound from the moment of injection until the moment of detection. Accordingly, it represents the time the analyte is in the mobile and stationary phase. The retention time is substance-specific and should always provide the same values under the same conditions.

#### Peak width ( $w$ )

The peak width covers the period from the beginning of the signal slope until reaching the baseline after repeated drop in the detector signal.

#### Tailing factor (T)

In practice, perfectly symmetric peaks are very rare. In a chromatogram they often show some degree of tailing. Peak tailing is measured by the tailing factor T. This factor describes the peak asymmetry, i.e. to which extent the shape is approximated to the perfectly symmetric Gaussian curve. The tailing factor is measured as:  $T=b/a$   
**a** represents the width of the front half of the peak, **b** is the width of the back half of the peak. The values are measured at 10 % of the peak height from the leading or trailing edge of the peak to a line dropped perpendicularly from the peak apex (see **Fig. 5**). [4]

$T = 1$  represents a symmetrical peak. For  $T > 1$  the peak profile is named tailing. For  $T < 1$  the peak profile is named fronting.

## RELATED KNAUER APPLICATIONS

[VSP0016](#) - Quantification of caffeine with the AZURA® Educational system and Mobile Control Software

[VSP0017](#) - Quantification of caffeine with the AZURA® Educational system and ClarityChrom software

[VSP0018](#) - Preparation of calibration and samples for the quantification of caffeine with the AZURA® Educational system

# Inject, collect, repeat - Stacked injection made easy

Johannes Menke, Kate Monks; [applications@knauer.net](mailto:applications@knauer.net)

KNAUER Wissenschaftliche Geräte GmbH, Hegauer Weg 38, 14163 Berlin; [www.knauer.net](http://www.knauer.net).

## SUMMARY

Stacked injections are an easy way to increase productivity and improve efficiency in preparative chromatography. With this approach multiple injections are nested in one batch run for a maximum throughput and minimum downtimes between peak collections. This technique saves time as well as solvent. The fraction collection is automated for ease of use and best reliability.

## INTRODUCTION

For preparative applications solvent consumption is oftentimes high whereas obtaining a decent yield is rather challenging. A way to improve both are stacked injections. Using this method system downtimes can be minimized thus leading to a more efficient overall purification process. The main aim of running stacked injections is to use the column bed more efficiently by reducing non elution phases, whilst retaining peak purity. Stacked injections can be an alternative as well if a column overload with target compound is desired but not possible without coelution of impurities or matrix compounds. The sample is loaded in such volumes, that sufficient target compound resolution is still achieved. Usually the yield would be minimal, but via stacked injection multiples of the actual sample volume are injected in one long run. For this method high robustness is needed, especially regarding retention time shifts. With a well-designed method injection cycles can be repeated almost indefinitely which allows a semi-continuous process.

Large batches of sample can be automatically processed without losing product purity. A requirement for stacked injections is a short isocratic method with all peaks eluting in close proximity. Ideally the time frame between injection and target peak is free of impurities. Consequently an impurity eluting with a long delay after the target peak makes stacked injections challenging if not impossible. Technical requirements for stacked injection are an automated sample injection system (sample pump and automated injection valve with sample loop or VariLoop), and a fractionation system (multi position valve or fraction collector). If solvent recycling is desired, a multi position valve for fractionation is necessary. Manually programming stacked injection methods is oftentimes time-consuming and complicated. The PurityChrom software includes a stacked injection function which was used in the described application (see materials and methods). It provides a tool for a dynamic method writing, making it easy to adjust cycle times and cycle numbers.



# Inject, collect, repeat - stacked injection made easy

## RESULTS

For the determination of the cycle-time (time until the first peak occurs) and to test the robustness several repetitive single runs with the established isocratic method were performed (Fig 1). From those measurements the delay time between injection and the first peak was determined, as well as the time for the signal to return to baseline after the last eluting peak. Parameters for automated fractionation (threshold, peak windows) were derived from these results as well. Once those parameters were determined stacked

injection mode was established easily with the PurityChrom software. The result for a run with three stacked injections is shown in Fig 2. In a doubled total runtime, a trifold sample volume was processed without losing any performance compared to two single batch injections (Fig 1). The use of an automated fractionation system eliminated the need of continuous human system surveillance whereas solvent recycling during the delay time made it possible to save on overall cost for a run.

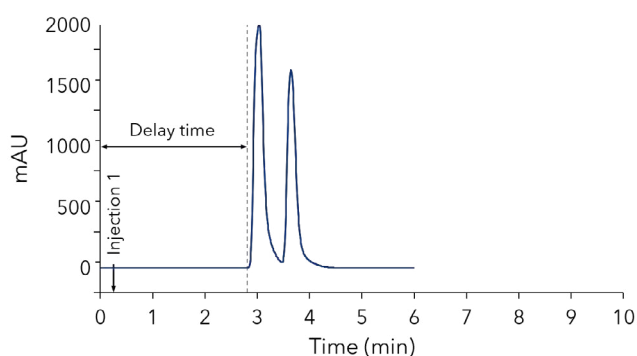


Fig. 1 Chromatogram of single injection; 500  $\mu$ L injection volume; flowrate 25 mL/min; eluent 25/75 ethanol/water (v/v); ambient temperature.

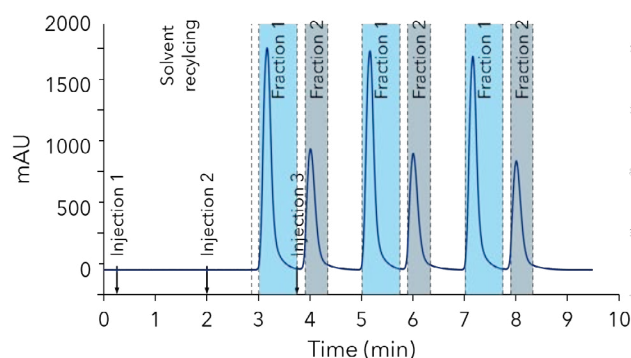


Fig. 2 Chromatogram of three stacked injections; 500  $\mu$ L injection volume per injection; flowrate 25 mL/min; eluent 25/75 ethanol/water (v/v); ambient temperature; automated fractionation.

## SAMPLE PREPARATIONS

An exemplary sample mixture of 2 mg/mL caffeine and 12 mg/mL paracetamol (acetaminophen) was prepared in 25/75 ethanol/water (v/v) and filtered through a 0.45  $\mu$ m RC-membrane (regenerated cellulose).

## CONCLUSION

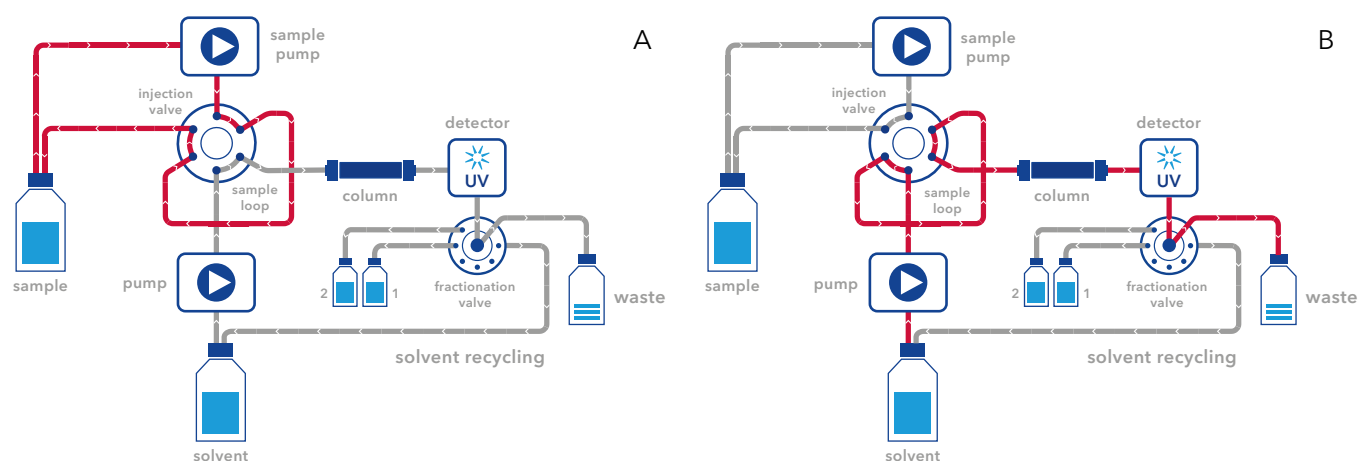
The shown example separation showed that the development and application of stacked injections for purification purposes is straightforward and easy with PurityChrom. All injection times are calculated by the software once the cycle time is determined. With the automated fractionation and solvent recycling, a highly autonomous process can be achieved. Even challenging fractionations could be automated with a

combination of threshold and peak window functions. Thus, large sample volumes can be processed efficiently without losing product purity. The overall runtime is shortened drastically compared to single batch runs, since in a stacked injection process the delay before the first peak is used already for the next injection. Consequently, time and solvent are saved even if solvent recycling is not an option.

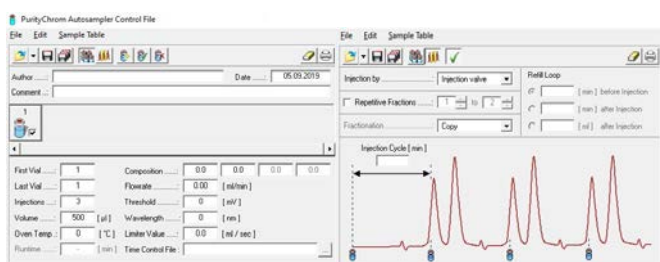
## MATERIALS AND METHODS

A preparative LC system as described in **Tab 4** was used. The method parameters are shown in **Tab 1 to Tab 3**. The flow cell was attached as close to the column exit as possible using the fiber optics adapter kit, decreasing any detection delays. The method of stacked injection was realized using the PurityChrom Software. The stacked injection functionality of the autosampler control file is used for an automatic injection by a sample pump via an injection valve (**Fig 3**). Critical parameters like cycle time and number of injections were transferred to the stacked injection function of PurityChrom (**Fig 4**). When a run was started the autosampler control file loads the time control file (method file) where all remaining method parameters are defined. The overall runtime is automatically extended by the autosampler control file, depending on the

number of chosen injections. The Flow chart is shown in **Fig 3**. As depicted, the sample is pumped with the sample pump in a circle, filling the sample loop constantly. On an injection event the content of the sample loop is directed into the main flow by switching the injection valve to the inject position. Until the first peak is occurring, the solvent is recycled. This is achieved using one position of the 12 port multi position valve for that purpose, in which the outlet is used to retransfer noncontaminated solvent into the solvent bottle. A second position is used for the waste, which is not recycled. Two more valve positions are defined for the fractionation of the respective target compounds. Every time a target peak appears in an injection cycle it is pooled in one fraction (**Fig 1**). The automation is realized using a combination of PurityChrom's peak sampling and threshold function.



**Fig. 3** System flowpath. The sample pump puts the sample in a circle to fill the sample loop constantly (A), before it is directed into the main flow (B).

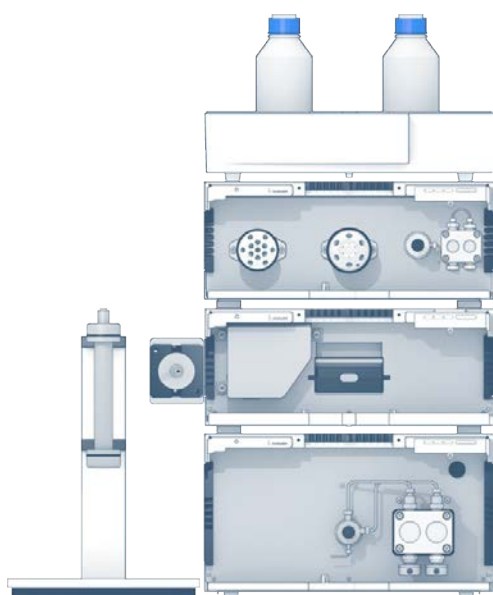


**Fig. 4** PurityChrom: Stacked Injection Function

## MATERIALS AND METHODS

**Tab. 1** Method parameters

Column temperature	ambient
Mode	Reversed phase
Injection volume	500 µL
Injection mode	Full loop; stacked or single
Detection	UV 273
Data rate	2 Hz



**Tab. 2** Pump

Eluent	25/75 ethanol/water (v/v)
Gradient	isocratic
Flow rate	25 mL/min
Run time	variable

**Tab. 3** Sample pump

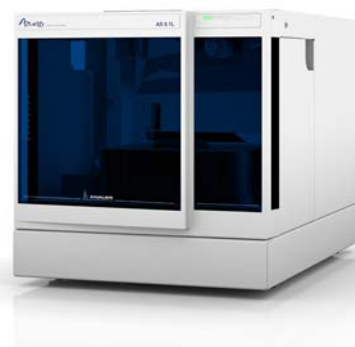
Eluent	sample
Gradient	isocratic
Flow rate	2 mL/min
Run time	variable

**Tab. 4** System configuration

Instrument	Description	Article No.
Pump	AZURA P 2.1L 250 ml pumphead, sst	<a href="#">APE20LA</a>
Detector	AZURA MWD 2.1L	<a href="#">ADB01</a>
Flow Cell	2 mm path length 1/8", 200 bar	<a href="#">A4079</a>
Detector accessory	Fibre Optics Adapter Kit	<a href="#">AMKX8KIT</a>
Assistant	AZURA ASM 2.1L Left: 12 port MPV, 1/8", sst Middle: 6 port, 2 position injection, 1/16", sst Right: P4.1S 50 ml pumphead, sst	<a href="#">AYFAEEBR</a>
Column	Eurospher II 100-20/45 C18, Column 250x20 mm ID	<a href="#">25JE181E2X</a>
Software	PurityChrom Version 5.9.96	<a href="#">A2650</a>

# Investigation of carryover under consideration of different washing solvents and volumes

Svea Stephan, Till Myrach, Carsten Losch, Kate Monks; applications@knauer.net  
KNAUER Wissenschaftliche Geräte GmbH, Hegauer Weg 38, 14163 Berlin; www.knauer.net.



## SUMMARY

In this study it was investigated to what extent the carryover correlates with the number of subsequent washing steps. Both the wash volume and the properties of the wash solutions have a significant effect on sample carryover. Using three washing steps (750  $\mu\text{L}$  total volume) sample carryover was reduced to less than 0.003 % for both analytes, caffeine and chlorhexidine. The sample carryover can be further reduced by a factor of 10 if the extended wash function is used. With the extended wash function, two different wash solutions are used. The first is usually a strong organic solvent, that should remove all remaining sample residues. The second wash solution is subsequently used to completely rinse the organic wash solution out of the fluidic system. The eluent with the lowest elution strength is particularly suitable for this purpose. In a sample application, using the described extended wash, a lower carryover of only 0.0003 % was achieved. This low value makes the procedure especially advantageous for trace analyses using highly sensitive MS/MS or electrochemical detectors.

## INTRODUCTION

Carryover is the appearance of a small sample peak when injecting a blank after the sample [1]. It is caused by sample residues which remained in the system after the preceding injection. One significant factor for carryover is the injection mode used. In microliter pickup mode only the volume of sample that should be injected is aspirated. When using the full loop mode on the contrary, not only the loop volume but also an additional volume of up to three times the loop volume is aspirated. This overfilling is done to ensure that the loop is completely filled with sample

guaranteeing maximum reproducibility. Furthermore, the carryover is also influenced by the sample itself as its adhesive properties define how strong it sticks to the surface area. To prevent a carryover between two analyses a thorough wash procedure is necessary to remove sample residues in the injection system. Especially with very sensitive detection methods minimizing carryover is necessary to avoid false-positive results. In this study the carryover of the auto-sampler KNAUER AZURA AS 6.1L was determined and an optimized washing procedure was developed.



# Investigation of carryover under consideration of different washing solvents and volumes

## RESULTS

One of the two main reasons for carryover are small cavities in the system. A tiny amount of sample in these reservoirs is diluted over time and the carryover decreases with every injection. This carryover can easily be determined with caffeine as analyte. The carryover of the AZURA HPLC system was analyzed for different injection modes and three different wash steps (Tab. 1).

**Tab. 1** Carryover of caffeine for different injection modes and with 1, 2 and 3 wash steps (250  $\mu\text{L}$  each)

Carryover [%]	Microliter pickup	Partial loop	Full loop
1 wash step	0.0000	0.0196	0.0000
2 wash steps	0.0000	0.0029	0.0000
3 wash steps	0.0000	0.0024	0.0000

Both in full loop and in microliter pickup injection mode no carryover is detectable even with only one wash step. In partial loop mode a carryover occurs but already two wash steps reduce it to under 0.005 %. The second main reason for carryover is a chemical adsorption of sample to the wetted surface of sample loop, needle, tubings and valves of the injection system. It can be determined with a sticky substance like chlorhexidine. The determination of the carryover of chlorhexidine was combined with the development of an optimized washing procedure for the AS 6.1L injection system (Tab. 2).

**Tab. 2** Carryover of chlorhexidine for different injection modes with 1, 2 and 3 wash steps (250  $\mu\text{L}$  each)

Carryover [%]	Microliter pickup	Partial loop	Full loop
1 wash step	0.0648	0.0171	0.0019
2 wash steps	0.0041	0.0020	0.0006
3 wash steps	0.0017	0.0019	0.0006

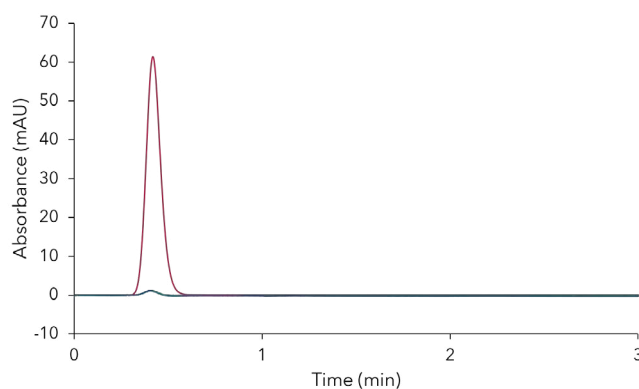
In all three injection modes two wash steps lead to a carryover of less than 0.005 %. Since the highest value was observed with microliter pickup, this mode was chosen to optimize the wash procedure. For this procedure two different wash solutions were used.

The first wash step with isopropanol should remove chlorhexidine, while the subsequent step with mobile phase is intended to remove the isopropanol again. Starting with a combination of 750  $\mu\text{L}$  isopropanol and 750  $\mu\text{L}$  eluent the volumes were increased in steps of 250  $\mu\text{L}$  up to 1500  $\mu\text{L}$ . The results for carryover are shown in Tab.3.

**Tab. 3** Carryover of chlorhexidine with different volumes of isopropanol used in the first washing step and eluent used in the second washing step

Wash step 1 Isopropanol [ $\mu\text{L}$ ]	Wash step 2 Eluent [ $\mu\text{L}$ ]	Carryover [%]
750	750	0,0028
1000	1000	0,0031
1250	1250	0,0022
1500	1500	0,0003
1500	750	0,0016

It is noticeable that there is no significant difference between 2 x 750  $\mu\text{L}$  and 2 x 1000  $\mu\text{L}$ . From 1250  $\mu\text{L}$  the carry over decreases significantly and at 1500  $\mu\text{L}$  almost no carry over is detectable. A combination of 1500  $\mu\text{L}$  isopropanol followed by 1500  $\mu\text{L}$  mobile phase led to a carryover of 0.0003 %. Fig. 1 shows the blanks before and after injection of the chlorhexidine standard with 2000  $\mu\text{g}/\text{mL}$  compared to the concentration of 10  $\mu\text{g}/\text{mL}$ . Whether the washing liquid isopropanol has to be adapted to the analyte should be investigated in each individual case.



**Fig. 1** Injection of chlorhexidine standard 10  $\mu\text{g}/\text{mL}$  (red), Blank 1 (blue) before and Blank 2 (green) after the injection injection of the chlorhexidine standard with 2000  $\mu\text{g}/\text{mL}$ , in between rinsing steps with 1500  $\mu\text{L}$  isopropanol and 1500  $\mu\text{L}$  eluent (microliter pickup mode).



## CONCLUSION

The carryover of the AZURA AS 6.1L resulting from small cavities in the system can be reduced to under 0.003% by including two wash steps. For system setups with sensitive detectors or while working with sticky substances the use of an optimized wash procedure can be beneficial. The wash procedure, which combines 1500  $\mu\text{L}$  isopropanol and 1500  $\mu\text{L}$  mobile phase, reduces the carryover to 0.0003% in partial loop injection mode. The carryover in full loop and microliter pickup mode is even lower. Since the value of sample carryover is both substance and method-specific, any method development should include an investigation of sample carryover. This investigation should consist of not only the chromatographic method but also the sample preparation.

## REFERENCES

[6] Zeng, W., Musson, D. G., Fisher, A. L. and Wang, A. Q. (2006), A new approach for evaluating carryover and its influence on quantitation in high-performance liquid chromatography and tandem mass spectrometry assay. *Rapid Commun. Mass Spectrom.*, 20: 635-640.

## MATERIALS AND METHODS

**Tab. 4** System configuration

Instrument	Description	Article No.
Pump	AZURA P6.1L HPG	<a href="#">APH35EA</a>
Autosampler	AZURA AS 6.1L	<a href="#">AAA00AA</a>
Detector	AZURA DAD 6.1L	<a href="#">ADC11</a>
Flow Cell	LightGuide UV Flow Cell, 10 mm, 2 µL	<a href="#">AMC19XA</a>
Thermostat	AZURA CT 2.1	<a href="#">A05852</a>
Restriction capillary	ID 0.18 mm, L 15 m	<a href="#">A3313</a>
Software	ClarityChrom 8.1	<a href="#">A1670</a>

Analyte	CAS	Manufacturer
Chlorhexidine	55-56-1	Sigma Aldrich
Caffeine	58-08-2	Sigma Aldrich

**Tab. 5** Method parameters for the determination of the carryover

Parameter	
Flowrate	1 mL/min
Eluent	water
Detection Wavelength	272 nm (caffeine)
257 nm (chlorhexidine)	0
Data Rate	10 Hz
Time constant	0.1 s
Injection volume	10 µL (microliter pickup, partial loop) 100 µL (full loop)
Buffer tubing	500 µL
Sample loop	100 µL
Needle tubing SSt	15 µL
Syringe	250 µL

**Tab. 6** Injection scheme for determination of carryover

No.	Sample	Explanation
1	Blank 1	Determination of the solvent peak
2	Low conc. (10 µg/µL)	Reference sample, for calculation of the carryover
3	high conc. (2000 µg/µL)	Highly concentrated sample, exceeding the linear range of the detector
4	Blank 2	
5	Blank 3	Determination of carryover
6	Blank 4	

**Tab. 7** Calculation of carryover

$$\text{Carryover} = \frac{A_{\text{Blank2}} - A_{\text{Blank1}}}{A_{\text{low}} * (C_{\text{high}} / C_{\text{low}})} * 100$$

$A_{\text{Blank1}}$ : Area of first blank injection

$A_{\text{Blank2}}$ : Area of second blank injection

$A_{\text{low}}$ : Area of the standard with low concentration

$C_{\text{high}}$ : Concentration of sample with high concentration

$C_{\text{low}}$ : Concentration of sample with low concentration

# When they go LOW, we go HIGH! Comparing sensitivity levels for the analysis of fluorescence-labeled proteins



Ulrike Krop, Maria Glanz, Kate Monks; [applications@knauer.net](mailto:applications@knauer.net)

KNAUER Wissenschaftliche Geräte GmbH, Hegauer Weg 38, 14163 Berlin; [www.knauer.net](http://www.knauer.net).

## SUMMARY

The use of a fluorescence detector increases the sensitivity of the chromatographic analysis. In this Tech Note we evaluated the different sensitivity modes of the fluorescence detector with a fluorescein-labeled protein and compared it to the UV signal.

## INTRODUCTION

The fluorescence detector is one of the spectroscopic detectors in chromatography. However, it is a lot more sensitive than UV/VIS detectors and responds selectively to compounds with a fluorophore. This detector excites the sample with excitation light and breaks up the emitted fluorescence light with a fluorescence monochromator. It extracts the required fluorescence wavelengths and measures the intensity with a photomultiplier. In bio science fluorescence labelling of proteins is often used to produce versatile tools for

a variety of research applications. These labelled proteins are often purified or analysed by FPLC. In this TechNote we used fluorescein (FITC) labeled bovine serum albumin (BSA) as a model protein. The fluorescence detector RF20AX is fully integrated in our FPLC software PurityChrom and can be set to three different sensitivity levels (HIGH, MED, LOW). The aim of this TechNote was to compare different protein concentrations and evaluate which sensitivity levels should be used.

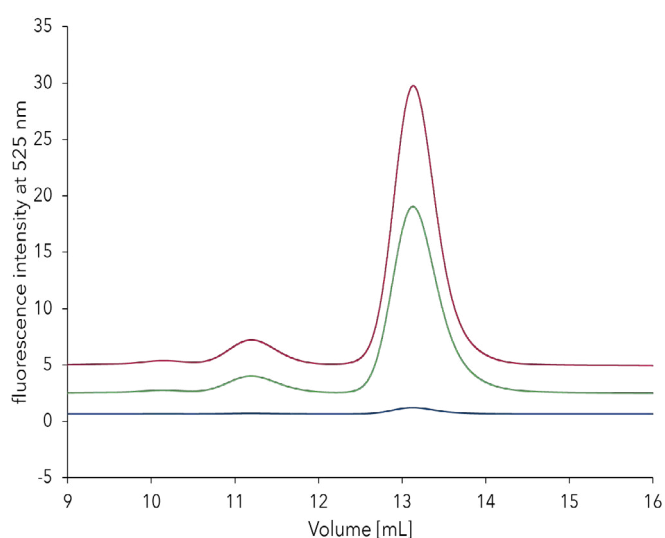


# When they go LOW, we go HIGH!

## Comparing sensitivity levels for the analysis of fluorescence-labeled proteins

### RESULTS

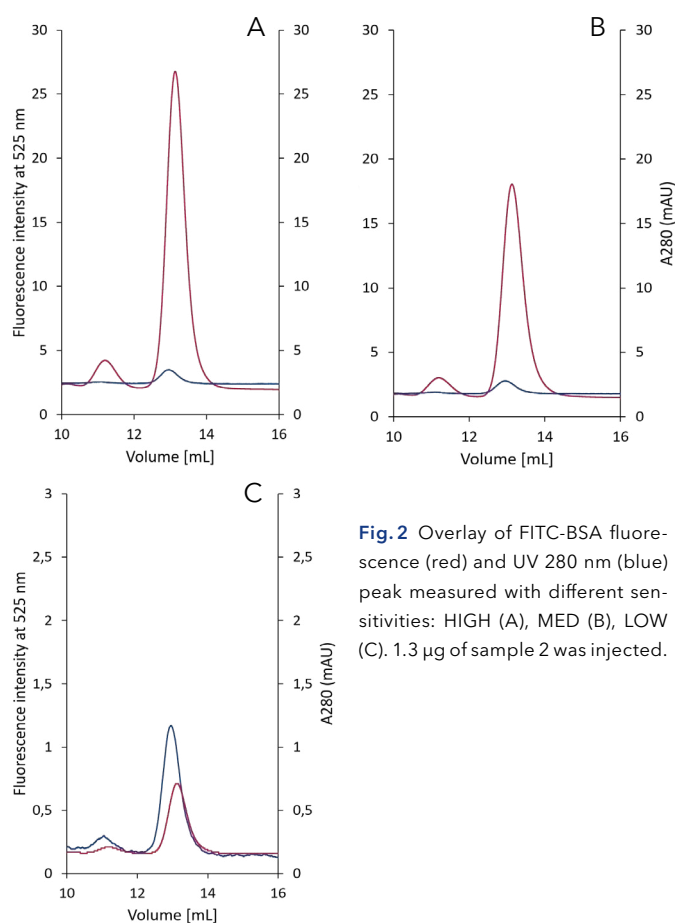
The FITC-BSA fluorescence signal was analysed for 8  $\mu\text{g}$  and 0.8  $\mu\text{g}$  of sample 1, as well for 13  $\mu\text{g}$  and 1.3  $\mu\text{g}$  of sample 2 with the HIGH, MED and LOW level mode. The corresponding peak areas were compared, and the ratios for the HIGH, MED and LOW level were determined. As the factors were comparable between the two samples with different molar ratios F/P, they are given as mean values over both samples (**Tab. 1**). Using the sensitivity mode HIGH and MED with the



**Fig. 1** Overlay of FITC-BSA fluorescence peak measured with different sensitivity modes (red line HIGH, green line MED, blue line LOW). 1.3  $\mu\text{g}$  of sample 2 was injected.

same conditions resulted in much higher fluorescence signal in comparison to LOW sensitivity (**Fig. 1**). The fluorescence peak area for the HIGH mode is more than 40 times higher than the LOW mode, while the MED mode shows a more than 30 times higher peak than the LOW mode. The peak area for the MED mode is increased by factor 1.33 in comparison to the HIGH mode. Next, the peak area of the fluorescence signal for different sensitivity levels was compared to the corresponding peak area of the UV signal (**Fig. 2 A-C**). Depending on the molar ratio of

the fluorescein and the protein the factors varied. With the HIGH sensitivity level the fluorescence signal peak area was between 24-fold and 29-fold higher than the peak area of the UV signal, while with the MED level the fluorescence peak area was still between 17 and 20 times higher than peak area of the UV signal. The LOW sensitivity resulted in smaller peak areas for the fluorescence signal with a factor in between 0.52 and 0.65 in comparison to the peak area of the UV signal (**Tab. 2**). Higher functionalization shown by higher molar ratios F/P did not result in higher factors comparing the fluorescence and UV signal (280 nm). Quenching effects of FITC could be an explanation for the phenomena. As this was not the scope of this work, it was not further analyzed.



**Fig. 2** Overlay of FITC-BSA fluorescence (red) and UV 280 nm (blue) peak measured with different sensitivities: HIGH (A), MED (B), LOW (C). 1.3  $\mu\text{g}$  of sample 2 was injected.

## SAMPLE PREPARATIONS

For the labelling of BSA with FITC BSA was dissolved in 0.1 M sodium carbonate (pH 9) at a final concentration of 2 mg/mL. FITC was dissolved in DMSO at a concentration of 1 mg/mL. 1 mL of BSA solution was carefully mixed with 20 µL FITC solution. The labelling reaction took place under two different conditions. The labelling was carried out at 4° C for 16 hours for sample 1 and at room temperature (RT) for 1.5 hours for sample 2. All solutions and samples were prepared fresh and the solutions containing FITC or BSA were protected from light. After labelling BSA with FITC, the protein-dye solution was purified with a 5 mL Sepapure Desalting column (020X460SPZ) using PBS as buffer. A maximum of 1 mL sample was applied onto the column. The labelled protein was collected and the fluorescein/protein (F/P) molar ratio was determined using the following equation:

$$\text{Molar F/P} = \frac{\text{MW}_{\text{BSA}}}{\text{MW}_{\text{FITC}}} \times \frac{(A_{495} / E^{0.1\% \text{ FITC}})}{[A_{280} - (0.35 \times A_{495})] / E^{0.1\% \text{ BSA}}}$$

Molecular weight FITC	389
Molecular weight BSA	66,430
Absorption FITC E <sup>0.1%*</sup>	195
Absorption BSA E <sup>0.1%**</sup>	44,308.81
Correction factor FITC	0.35 x A <sub>495</sub>

\* Absorption at 490 nm at pH 13.

\*\* Absorption at 280 nm of a protein at 1.0 mg/mL.

The absorbance of the conjugate sample was determined at 280 and 495 nm. For sample 1 a molar ratio of fluorophore per protein 1.13 and for sample 2 a molar ratio of 0.3 was calculated. As protein concentration determination by UV 280 nm is misleading, protein concentration was calculated from the used starting material. For the first labelling (sample 1) 8 mg BSA and for the second labelling (sample 2) 3 mg BSA were used. After purification a total volume of 9.6 mL for sample 1 and 3 mL for sample 2 was collected. From this a concentration reached 0.8 mg/mL for sample 1. 1.3 mg/mL were calculated for sample 2. Using the AZURA Bio Lab system for the first sample 8 µg and 0.8 µg were analysed, for the second sample 13 µg and 1.3 µg.

## CONCLUSION

With the fluorescence detector the sensitivity of the chromatographic measurement of fluorescently labelled proteins can be increased. The HIGH sensitivity level results in more than 40 times higher and the MED level results in more than 30 times higher peak areas in comparison to the LOW level mode. The HIGH sensitivity mode can be used for labelled protein amounts in the low µg and high ng range. For higher protein amounts the LOW mode should be used.

## MATERIALS AND METHODS

**Tab. 1** Factor of peak area increase comparing different FLD sensitivities

Sensitivities	Factor
LOW vs. HIGH	43.2 ± 1
LOW vs. MED	32.5 ± 0.8
MED vs. HIGH	1.33 ± 0.01

**Tab. 2** Comparison of fluorescence and UV 280 nm peak area

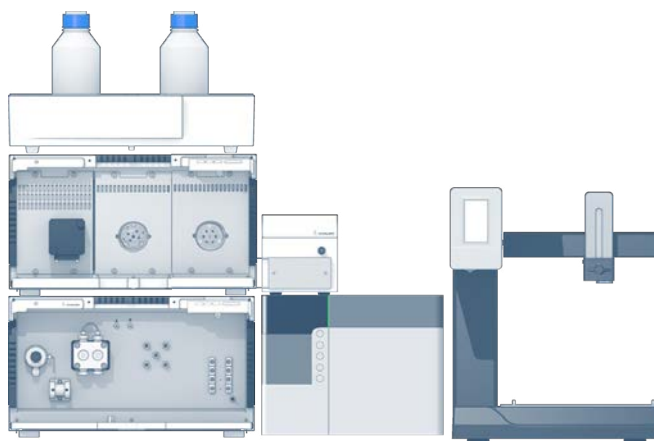
Sensitivity	BSA FITC Molar F/P	Factor
HIGH	1.13	24 ± 0,2
HIGH	0.3	29.3 ± 0.6
MED	1.13	17.4 ± 0.5
MED	0.3	20.5 ± 1
LOW	1.13	0.52 ± 0.04
LOW	0.3	0.65 ± 0.03

**Tab. 3** Method parameters

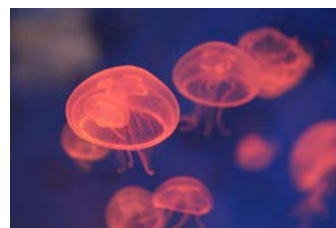
Buffer A	PBS (phosphate buffered saline, pH 7.4)
Gradient	isocratic
Flow rate	1,8 mL/min
Run temperature	RT
Injection volume	100 µL or 10 µL
Detection wavelength UV	280 nm
Excitation wavelength FLD	495 nm
Emission wavelength FLD	525 nm
System pressure	~ 42 bar
Run volume	min. 1 CV (24 mL)
Data rate	min. 2 Hz

**Tab. 4** System configuration

Instrument	Description	Article No.
P6.1L	Metal-free, low pressure gradient FPLC pump with 10 mL ceramic pump head, degasser and 250 µL mixer	<a href="#">APH64EB</a>
ASM 2.2L	<b>Left:</b> UVD2.1S variable single wavelength UV detector <b>Middle:</b> valve drive VU 4.1 <b>Right:</b> valve drive VU 4.1	<a href="#">AY00001</a>
Flow Cell UV	Semi-preparative bio-compatible 3 mm UV Flow Cell, 1/16"	<a href="#">A4045</a>
V4.1	Biocompatible multi-injection valve, 1/16"	<a href="#">AVN94CE</a>
V4.1	Biocompatible two-position valve, 6 port	<a href="#">AVD24CE</a>
CM2.1S	Conductivity monitor with flow cell for up to 100 mL/min flow rate	<a href="#">ADG30GD</a>
RF20A	Fluorescence detector	<a href="#">A59200</a>
Flow Cell FLD	Bioinert Flow Cell for fluorescence detector	<a href="#">A59212</a>
Foxy R1	Fraction collector	<a href="#">A59100</a>
Software	PurityChrom	<a href="#">A2650</a> <a href="#">A2652</a>
Column	Prepacked SEC (10 x 300 mm) column for small-scale preparative purification, as well as for characterization and analysis of proteins with molecular weights (Mr) from 10,000 to 600,000, column volume (CV) 24 mL	



# Boosting your sensitivity - Analysis of fluorescence-labeled proteins with semi-preparative FPLC and FLD



Ulrike Krop, Maria Glanz, Kate Monks; [applications@knauer.net](mailto:applications@knauer.net)

KNAUER Wissenschaftliche Geräte GmbH, Hegauer Weg 38, 14163 Berlin; [www.knauer.net](http://www.knauer.net).

## SUMMARY

In many bioscience applications, fluorescence-labeled proteins are used to analyze cellular and biological functions. Here, fluorescein (FITC) and bovine serum albumin (BSA) were used as model molecules. We tested the integration of a fluorescence detector (FLD) into a semi-preparative FPLC system and evaluated the analysis of FITC labeled BSA in comparison with classical UV/VIS detection. The use of a fluorescence detector increases the sensitivity of the chromatographic analysis significantly.

## INTRODUCTION

Fluorescence labeling of proteins is a versatile tool for a variety of research applications. By creating a labeled biomolecule this can be used for cell tracing, receptor labeling as well as in immunohistochemistry and cytochemistry. It helps analyzing biological structure, function and interactions of proteins and is used in many bioscience protocols. We used fluorescein (FITC) labeled bovine serum albumin (BSA) as a model protein. FITC is one of the most common fluorescent reagents for biological research because of its high absorptivity, excellent fluorescence quantum yield, and good water solubility. BSA is a protein derived

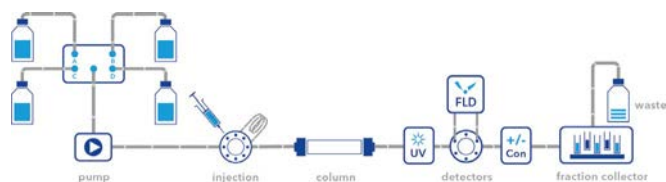
from the blood serum of cows. It is often used for experiments due to its low cost, stability and broad availability. The protocol for labeling proteins involves a chromatographic purification step. Furthermore, fluorescence-labeled proteins can be as well used for chromatographic analysis as fluorescence detection responds selectively to compounds with a fluorophore and is more sensitive than UV/VIS detection. Here we integrated a fluorescence detector into a semi-preparative FPLC system and examined the analysis of a FITC labeled BSA comparing it to classical UV/VIS detection.



# Boosting your sensitivity - Analysis of fluorescence-labeled proteins with semi-preparative FPLC and FLD

## RESULTS

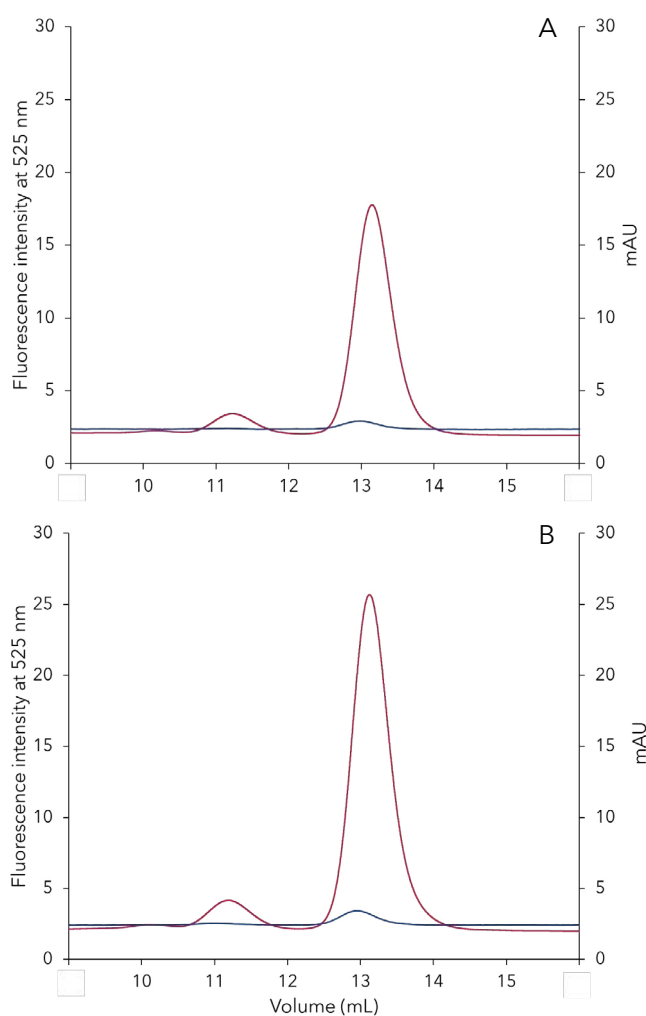
A semi-preparative FPLC system was equipped with an additional fluorescence detector. The fluorescence detector has a biocompatible analytical flow cell which generates a back pressure due to its small inner diameter. First the back pressure of the system set up was analyzed. Water at room temperature generated a back pressure of around 1 bar for 1 mL/min and 2 bar at 2 mL/min. Increasing the flow rate will result in higher back pressure. Therefore we recommend to use flow rates below 2 mL/min if the fluorescence detector is used with pressure sensitive FPLC cartridges or columns. Special care should be taken by choosing the columns. The fluorescence detector can certainly be operated with pressure resistant columns. Additionally, the fluorescence detector should be used with a bypass valve in a semi-preparative system. By using this option, the fluorescence detector can be integrated into the flow in case of need (Fig 1).



**Fig. 1** Flow scheme of a typical semi-preparative FPLC system with fluorescence detector with bypass option.

FITC-BSA fluorescence signal was analyzed for 0.8  $\mu\text{g}$  of sample 1 and 1.3  $\mu\text{g}$  of sample 2 with the HIGH level mode (Fig. 2) The corresponding peak areas for the UV and fluorescence signal were determined, compared and the mean was calculated for the UV and fluorescence signal peak areas. Depending on the molar ratio of FITC and BSA the factors varied. The fluorescence signal peak area was between 24-fold and 29-fold higher than the peak area of the UV signal (Tab. 1). Surprisingly higher functionalization shown by higher molar ratios F/P did not lead to higher factors comparing the fluorescence and UV 280 nm signal. An explanation

for this might be quenching effects due to higher FITC functionalization. Since this phenomenon was not the scope of the work it was not further studied.



**Fig. 2** Overlay of FITC-BSA peak measured with fluorescence (red) and UV 280 nm (blue). Sample 1 with 0.8  $\mu\text{g}$  (A) and sample 2 with 1.3  $\mu\text{g}$  (B).

**Tab. 1** Factor of peak area increase comparing different FLD sensitivities

Sample	Concentration ( $\mu\text{g}$ )	FITC-BSA molar F/P	Mean peak area - FLD (HIGH level)	Mean peak area - UV 280 nm	Factor
1	0.8	1.13	505.6	21.1	24
2	1.3	0.3	349.6	12	29.1



## SAMPLE PREPARATIONS

For the labeling of BSA with FITC, BSA was dissolved in 0.1 M Sodium carbonate pH 9 at a final concentration of 2 mg/mL. FITC was dissolved in DMSO at a concentration of 1 mg/mL. 1 mL of BSA solution was carefully mixed with 20  $\mu$ L FITC solution. The labeling reaction took place under two different conditions. The labeling was carried out at 4° C for 16 hours for sample 1 and at room temperature (RT) for 1.5 hours for sample 2. All solutions and samples were prepared fresh and the solutions containing FITC or BSA labeled with FITC were protected from light. After labeling BSA with FITC, the protein-dye solution was purified with a 5 mL Sepapure Desalting column (020X460SPZ) using PBS as buffer. A maximum of 1 mL sample was applied onto the column. The labeled protein was collected and the fluorescein/protein (F/P) molar ratio was determined using the following equation:

$$\text{Molar F/P} = \frac{\text{MW}_{\text{BSA}}}{\text{MW}_{\text{FITC}}} \times \frac{(A_{495} / E^{0.1\% \text{ FITC}})}{[A_{280} - (0.35 \times A_{495})] / E^{0.1\% \text{ BSA}}}$$

## CONCLUSION

A semi-preparative FPLC system can easily be used with a fluorescence detector to analyze fluorescence-labeled proteins. The focus of the fluorescence detection is analytical. Special care should be taken by choosing the columns. An additional bypass valve should be integrated into the system to switch the fluorescence

Molecular weight FITC	389
Molecular weight BSA	66,430
Absorption FITC E <sup>0.1%*</sup>	195
Absorption BSA E <sup>0.1%**</sup>	44,308.81
Correction factor FITC	0.35 x A <sub>495</sub>

\* Absorption at 490 nm at pH 13.

\*\* Absorption at 280 nm of a protein at 1.0 mg/mL.

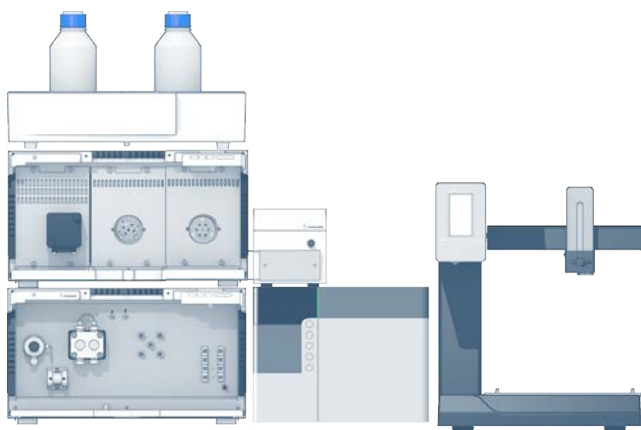
The absorbance of the conjugate sample was determined at 280 and 495 nm. For sample 1 a molar ratio of fluorophore per protein 1.13 and for sample 2 a molar ratio of 0.3 was calculated. As protein concentration determination by UV 280 nm is misleading, protein concentration was calculated from the used material. For the first labeling (sample 1) 8 mg BSA and for the second labeling (sample 2) 3 mg BSA were used. After purification a total volume of 9.6 mL for sample 1 and 3 mL for sample 2 was collected. From this a concentration reached 0.8 mg/mL for sample 1. 1.3 mg/mL were calculated for sample 2. For the first sample 0.8  $\mu$ g and for sample 2 1.3  $\mu$ g were injected. The FITC labeled BSA was analyzed with a KNAUER FPLC system including a fluorescence detector and a prepacked semi-preparative SEC column. Each run for each sensitivity level was measured minimum in duplicates.

detector into the flow. The use of a fluorescence detector increased the sensitivity of the chromatographic measurement of fluorescence-labeled proteins in our study by factors between 24 to 29 fold. Thus, the use of a fluorescence detector increases the sensitivity of the chromatographic analysis significantly.

## MATERIALS AND METHODS

**Tab. 2** Method parameters

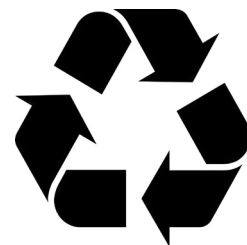
Buffer A	PBS (phosphate buffered saline, pH 7.4)
Gradient	isocratic
Flow rate	1.8 mL/min
Run temperature	RT
Injection volume	10 µL
Detection wavelength UV	280 nm
Excitation wavelength FLD	495 nm
Emission wavelength FLD	525 nm
Mode fluorescence detector	HIGH
System pressure	~ 42 bar
Run volume	min. 1 CV (24 mL)
Data rate	min. 2 Hz



**Tab. 3** System configuration

Instrument	Description	Article No.
P6.1L	Metal-free, low pressure gradient FPLC pump with 10 mL ceramic pump head, degasser and 250 µL mixer	<a href="#">APH64EB</a>
ASM 2.2L	<b>Left:</b> UVD2.1S variable single wavelength UV detector <b>Middle:</b> valve drive VU 4.1 <b>Right:</b> valve drive VU 4.1	<a href="#">AY00001</a>
Flow Cell UV	Semi-preparative bio-compatible 3 mm UV Flow Cell, 1/16"	<a href="#">A4045</a>
V4.1	Biocompatible multi-injection valve, 1/16"	<a href="#">AVN94CE</a>
V4.1	Biocompatible two-position valve, 6 port	<a href="#">AVD24CE</a>
CM2.1S	Conductivity monitor with flow cell for up to 100 mL/min flow rate	<a href="#">ADG30GD</a>
RF20A	Fluorescence detector	<a href="#">A59200</a>
Flow Cell FLD	Bioinert Flow Cell for fluorescence detector	<a href="#">A59212</a>
Foxy R1	Fraction collector	<a href="#">A59100</a>
Software	PurityChrom	<a href="#">A2650</a> <a href="#">A2652</a>
Column	Prepacked SEC (10 x 300 mm) column for small-scale preparative purification, as well as for characterization and analysis of proteins with molecular weights (Mr) from 10,000 to 600,000, column volume (CV) 24 mL	

# Recycle your peaks - A comparison of two recycling methods



Johannes Menke, Kate Monks; applications@knauer.net

KNAUER Wissenschaftliche Geräte GmbH, Hegauer Weg 38, 14163 Berlin; www.knauer.net

## SUMMARY

When facing a difficult separation of two peaks, recycling chromatography can be a solution for this issue. The general principle for all approaches is to redirect the partially separated analytes through the column several times. This simulates an infinite column length. Different methods are established for this task. One example is the use of a T-fitting adapter and pumping in a closed circuit once the sample has been injected. Another technique is the alternate pumping recycling chromatography. This method uses a combination of two columns with identical dimensions and a 2-position-6-port -valve. The columns are switched in an alternating way, so that the sample enters the second column after leaving the first. Once the sample is in the second column, the valve is switched so that the first column will receive the sample again. Both methods have their advantages and disadvantages regarding to parameters such as system dead volume, detection, instrument complexity or method development time. Therefore, both techniques were evaluated using the same preparative HPLC instrument, as well as the same separation method and sample parameters. A comparison of both approaches achieves the superiority of the alternate pumping method. After five column cycles and a similar runtime this technique showed a better resolution of the target substances.

## INTRODUCTION

Recycling chromatography is an interesting method for a variety of applications that have one task in common being hard to separate substances. For this application an exemplary mixture of two steviolglycosides was used, but many other examples are imaginable, for instance the separation of chiral compounds. This

principle could also be used in preparative chromatography to achieve higher

compound purities despite loading more sample compared to a single run. The common principle of recycling chromatography is to redirect the peaks of interest through the column multiple times. Hence, an infinite column length is simulated, leading to a better target peak resolution. Two different approaches were tested in this application. One was the classical method of peak recycling through the pump and the other was



Additional Information

# Recycle Your Peaks – A comparison of two recycling methods

## INTRODUCTION

the method of alternate pumping. In the classical method, a T-fitting adapter is mounted in front of the pump inlet and connected to a multi-position valve, that serves as a fractionation valve and is located after the detector (Fig. 1). Once the sample is injected using the 2-port-6-position injection valve, the fractionation valve is switched to the recycling position. A closed circuit is established. The compounds of interest are redirected into the main flow path using the T-fitting. After passing the main pump they are separated once more on the stationary phase. This cycle is repeated until the target resolution is reached or the peak broadening prevents any further recycling. After every cycle the substances are detected with the detector and the grade of separation is visible. At the end, the target substances can be collected with the fractionation valve. With the method of alternate pumping, a redirecting of the flow through the main pump is avoided. This is achieved by using a second column of identical dimensions and another 2-position-6-port valve (Fig. 2), which serves as recycling valve. The columns are connected in such a way, that when the target compounds leave the first column, they enter the second column. Switching the recycling valve then connects the second columns exit to the first

columns inlet. Similar to the recycling through pump approach, this switching cycle is repeated until the target resolution is reached or the peak broadening exceeds one column volume. The switching time of the recycling valve needs to be determined in advance. For this purpose a single run with one column is performed to determine the retention times of the target compounds. Contrary to the recycling through pump technique the detector is located outside the recycling circuit. Therefore the resolution of the target compound is detected after the separation is finished. Hence, the process cannot be monitored online unless a second detector is available. For the purpose of fractionation, a multi-position valve or a fraction collector is connected after the detector. Solvent recycling can be used with both methods. While the recycling through pump method operates in a closed circuit, the alternate pumping method requires a fractionation valve and a threshold function to recycle the solvent. To compare the performance of both recycling techniques an established preparative HPLC method (VFD0170 & VFD0171) for the separation of Rebaudioside A and Stevioside was scaled down to a semi-preparative scale.

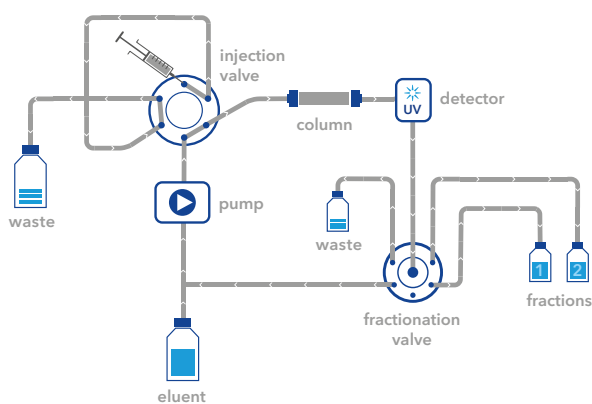


Fig. 1 Flowpath for recycling through pump approach.

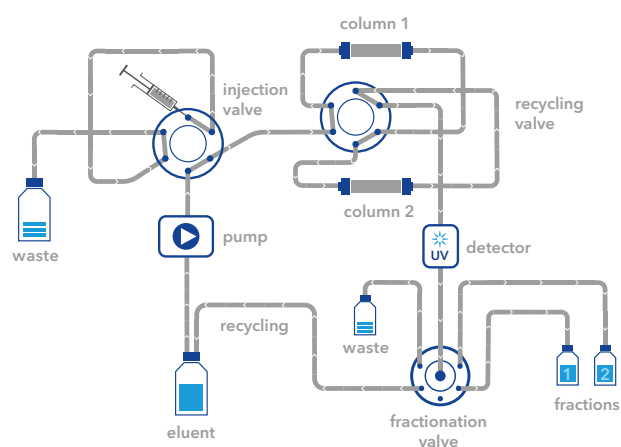
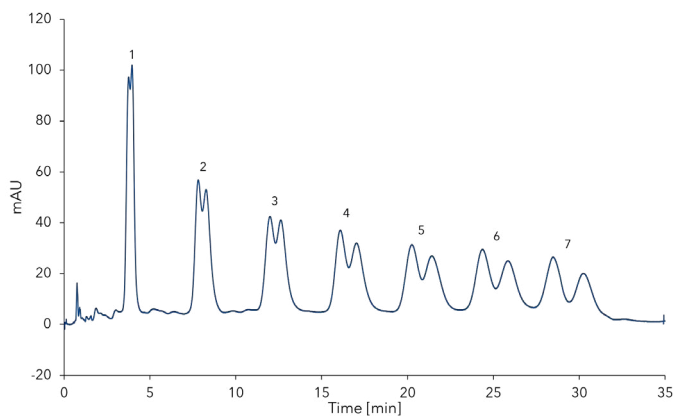


Fig. 2 Flowpath for alternate pumping approach.

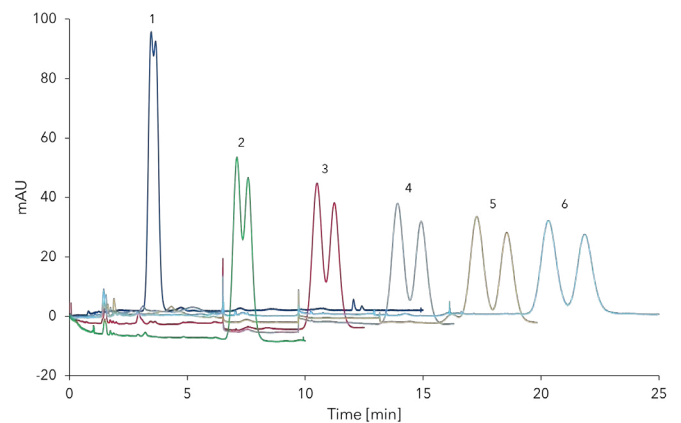
## RESULTS

The result of the recycling through pump method is depicted in Fig. 3. Since the detector is inside the closed circuit, the result of increasing cycle numbers can be acquired with one measurement. Increasing cycle numbers lead to increased peak resolution, whereas signal height decreases, and the peak width broadens. A maximum number of seven cycles was possible before peak broadening prevented another cycle. With the alternate pumping method, it can be seen, that with every subsequent cycle the target peak resolution increases as well (Fig. 4). After six cycles the maximal possible resolution (1.29) is reached, since both peak

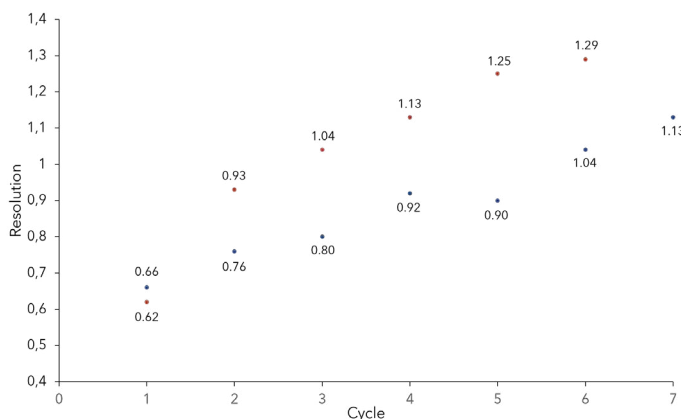
widths equal one column volume. Hence the target substances can no longer be separated with the given column bed. A comparison of the resolutions is shown in Fig. 5, where it can be seen that the maximum resolution of 1.13 reached with the recycling through pump method was achieved in three cycles less with the alternate pumping method. With the latter method a maximum resolution of 1.29 was reached. As expected the peak areas for each cycle stay the same, whereas the peak width increases. No sample was lost during the two different peak recycling methods (Fig. 6).



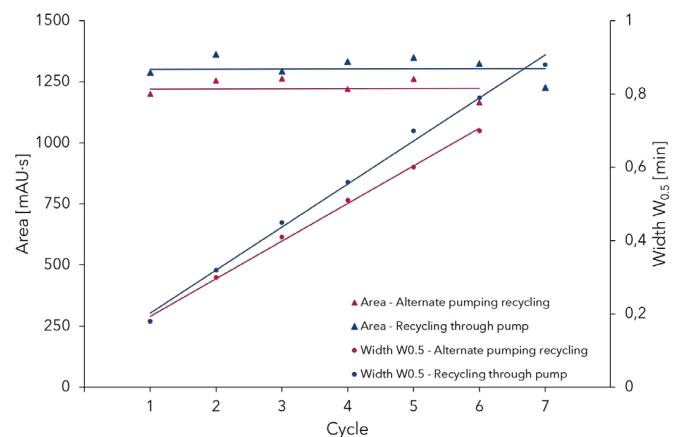
**Fig. 3** Recycling through pump. One measurement with seven cycles (1 to 7); 3.5 mL/min; 100  $\mu$ L injection of standard with 0.2 mg/mL Rebaudioside A and Stevioside.



**Fig. 4** Overlay of chromatograms for alternate pumping recycling chromatography. Comparison of six measurements with increasing cycle numbers (1 to 6); 3.5 mL/min; 100  $\mu$ L injection of standard with 0.2 mg/mL Rebaudioside A and Stevioside.



**Fig. 5** Comparison of resolution for the target substances. Alternate pumping recycling (red); Recycling through pump (blue).



**Fig. 6** Comparison of width W<sub>0.5</sub> and area for both recycling methods (regarding Rebaudioside A peak)

# Recycle Your Peaks – A comparison of two recycling methods

## SAMPLE PREPARATIONS

A stock solution containing 10 mg/mL of Stevioside and 10 mg/mL of Rebaudioside A was prepared using 30:70 acetonitrile/distilled water (v/v) as solvent. The stock solution was diluted with a ratio of 1:50 with

30:70 acetonitrile/distilled water (v/v) to achieve a target concentration of 0.2 mg/mL for each compound. The sample was filtered through a 0.45  $\mu\text{m}$  RC-membrane (regenerated cellulose) before injection.

## CONCLUSION

Both methods show that difficult separations are possible using recycling chromatography. The recycling through pump approach has the advantage that the instrument configuration is rather straightforward. Method development is easy since the process can be monitored online with the detector. Because of the closed circuit the solvent consumption is low. The main disadvantage of the recycling through pump approach is the large dead volume. Any tubing before and after the column, the pump head inside, or the mixing chamber increases the dead volume. This causes the substances to partially remix after leaving the stationary phase. In consequence a fast peak broadening is observed. Another disadvantage is that the pump and eluent delivery system is contaminated with the sample. Depending on the intended application, this can be a major drawback. Compared to the classic alrecycling through pump approach, the alternate pumping technique eliminates some of the drawbacks mentioned before. First and foremost, the

sample never comes into direct contact with the eluent delivery system, thus avoiding its contamination. Furthermore, the dead volume is significantly smaller since only the tubing between the column inlets and outlets and the dead volume of the recycling valve are accounted for. Hence, peak broadening happens not as fast with increasing cycle numbers as with the cycling through pump method. Thus, the resolution of the target peaks increases also faster. In the given example, the same resolution can be achieved three cycles earlier. This results in a shorter overall runtime. One of the disadvantages of the alternate pumping method is, that a second column and valve are needed, leading to higher instrument complexity. The process cannot be easily monitored online, since the detector is usually outside of the recycling circuit. Nevertheless, the alternate pumping technique shows a better resolution of the target substances and is therefore more suitable for separating the sample.

## MATERIALS AND METHODS

**Tab. 1** Instrument setup

Column temperature	ambient
Injection volume	100 µL
Injection mode	Full loop
Detection	UV 210 nm
Data rate	2 Hz

**Tab. 2** Pump parameter

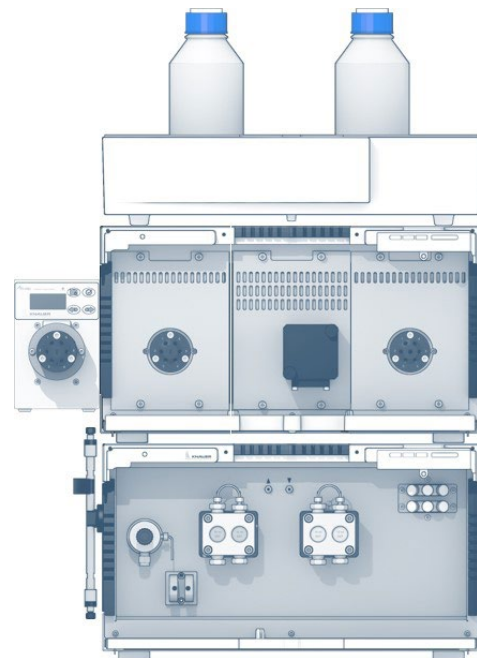
Eluent (A)	30:70 Acetonitrile/water (v/v)
Flow rate	3.5 mL/min

**Tab. 3** Optimal system configuration (Alternate pumping)

Instrument	Description	Article No.
Pump	AZURA P6.1L HPG 50 mL pump head sst	<a href="#">APH38FA</a>
Assistant	AZURA Assistant ASM 2.2L Left module: Valve drive VU 4.1 Middle module: UV detector Right module: Valve drive VU 4.1	<a href="#">AY00593</a>
Valve	2-position valve, 6 Port	<a href="#">AVD26AE</a>
Valve	Multiposition valve, 6 Port	<a href="#">AVS26AE</a>
Valve Drive	AZURA Valve Unifier VU 4.1	<a href="#">AWA01</a>
Valve	2-position valve, 6 Port	<a href="#">AVD26AE</a>
Flow Cell	Semi-preparative 3 mm UV Flow Cell 3 mm path length, 1/16", 2 µl volume, 300 bar, stainless steel	<a href="#">A4042</a>
Columns	Vertex 3 Eurospher 100-10 C18, Column 125 x 8 mm Vertex 3 Eurospher 100-10 C18, Column 125 x 8 mm	<a href="#">12GE181ESN</a>
Software	PurityChrom 5.09.069	<a href="#">A2650</a>

**Tab. 4** Optimal system configuration (Recycling through pump)

Instrument	Description	Article No.
Pump	AZURA P6.1L HPG 50 mL pump head sst	<a href="#">APH38FA</a>
Assistant	AZURA Assistant ASM 2.2L Left module: Valve drive VU 4.1 Middle module: UV detector UVD 2.1S Right module: Valve drive VU 4.1	<a href="#">AY00593</a>
Valve	2-position valve, 6 Port	<a href="#">AVD26AE</a>
Valve	Multiposition valve, 6 Port	<a href="#">AVS26AE</a>
Flow Cell	Semi-preparative 3 mm UV Flow Cell 3 mm path length, 1/16", 2 µl volume, 300 bar, stainless steel	<a href="#">A4042</a>
Column	Vertex 3 Eurospher 100-10 C18, Column 125 x 8 mm	<a href="#">12GE181ESN</a>
Software	PurityChrom 5.09.069	<a href="#">A2650</a>



## RELATED KNAUER APPLICATIONS

[VFD0170](#) - Scale-Up of an analytical HPLC method for steviol glycosides to a preparative approach

[VFD0171](#) - Evaluating preparative online SPE for the purification of stevia leave extracts



# Start up, shut down - Screening of pressure sensitive columns with the 8 port 2-position valve



Juliane Böttcher, Till Myrach, Mareike Margraf, Kate Monks; applications@knauer.net  
KNAUER Wissenschaftliche Geräte GmbH, Hegauer Weg 38, 14163 Berlin; www.knauer.net.

## SUMMARY

Using valves in FPLC is most often necessary due to manual injection, column switching or fractionation. But also common analytical HPLC applications can be improved by adding valves. Widespread analytical application areas are for example column screenings to find the suitable column. A large variety of valves is available, but not all are suitable for the screening of pressure sensitive columns. This note describes an application of a KNAUER 8 port 2-position valve in a screening process with Eurokat columns.

## INTRODUCTION

The KNAUER Eurokat polymer columns are based on a sulfonated cross-linked styrenedivinylbenzene copolymer and available in several ionic forms (H, Ca, Pb and Ag). This cation exchanger is characterized by an outstanding density of functional groups, making it the ideal choice for ion exclusion, size exclusion and ligand exchange chromatography. Due to the degree of cross-linkage of the polymer, the Eurokat columns are pressure sensitive. They are operated at an elevated

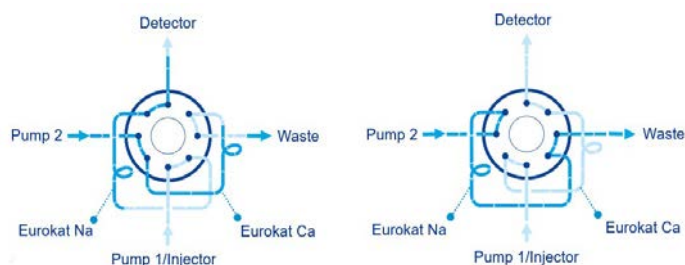
temperature ranging from about 60 °C to 85 °C. To prevent a sudden pressure increase it is also necessary to raise the flow rate slowly and gradually until the desired value is reached. Due to the permanent flow required for Eurokat columns, the use of a multiposition valve for screening purposes is not applicable. However, as it allows simultaneous flow on two columns, the KNAUER 8 port 2-position valve is a good alternative to allow screening with sensitive Eurokat columns..



# Start up, shut down - Screening of pressure sensitive columns with the 8 port 2-position valve

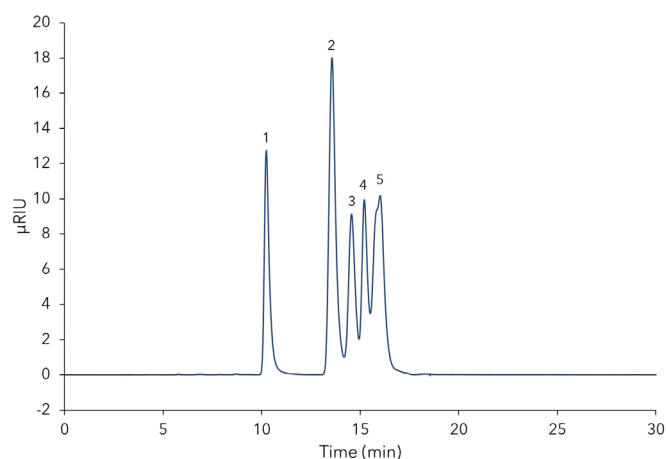
## RESULTS

Single standards for identification and a mixed standard of six carbohydrates (arabinose, mannitol, cellobiose, xylose, glucose, xylitol) and glycerine were measured on two different Eurokat columns. The columns were connected to the KNAUER 8 port 2-position valve. Thereby it is possible to maintain a permanent and constant flow rate on both columns and the time-consuming step of changing the column, heating it up and slowly increase the flow rate is not necessary. **Fig. 1** shows the connection of the columns and other devices to the valve. In position 1 the Eurokat Na column is in the injector flow path. When position 2 is selected the analysis is carried out on the Eurokat Ca column. Instead of configuring two separate pumps an AZURA HPG pump was altered, so that the columns could be operated each with one pump head.



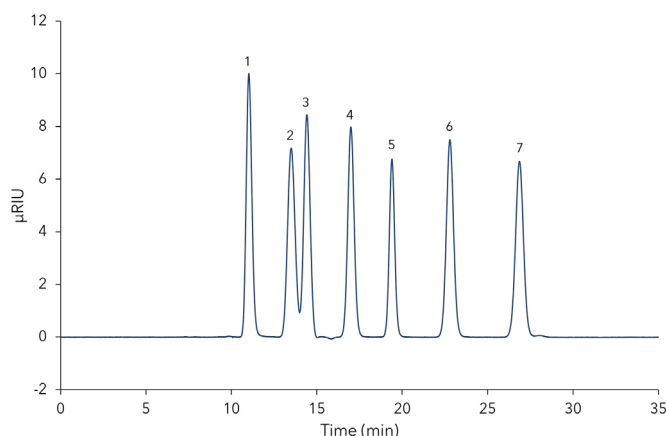
**Fig. 1** Switching of 8 port 2-position valve. Position 1 - left, position 2 - right.

On the Eurokat Na column not all substances were separated properly. Mannitol and glucose are eluting at the same time as well as glycerine and arabinose. **Fig. 2** shows the measurement of the mixed standard on the sodium phase.



**Fig. 2** Mixed standard on Eurokat Na. 1 - Cellobiose, 2 - Mannitol/Glucose, 3 - Xylose, 4 - Xylitol, 5 - Glycerin/Arabinose.

Using the additional valve, it is now possible to directly inject the sample onto the second column without the need of any changes. On the Eurokat Ca column the resolution of the substances could be improved. The elution order is different from the measurement on the sodium phase. Only glucose and xylose were not baseline separated. **Fig. 3** shows the chromatogram of the mixed standard on the calcium phase.



**Fig. 3** Mixed standard on Eurokat Ca. 1 - Cellobiose, 2 - Glucose, 3 - Xylose, 4 - Arabinose, 5 - Glycerin, 6 - Mannitol, 7 - Xylitol.

## SAMPLE PREPARATIONS

All standards were dissolved in water.

## CONCLUSION

Depending on the valve position one column is in the flow path of the injector and detector, whereas the second column is also ready for measurement. The standards or samples can be analysed on the first column and afterwards directly on the second one because the flow rate is kept constant for both. Concerning the complex handling of Eurokat columns, it is not necessary to change the column manually, heat

it up again and slowly rise the flow rate. For screening tasks with pressure sensitive columns or column materials the use of the KNAUER 8 port 2-position valve is advisable to save time that otherwise is spend on changing and equilibrating the second column. Besides screening challenges there are more applications the 8 port 2-position valve can be used for, e.g. comprehensive or "heart-cut" 2D-LC.

## MATERIALS AND METHODS

**Tab. 1** Method parameters

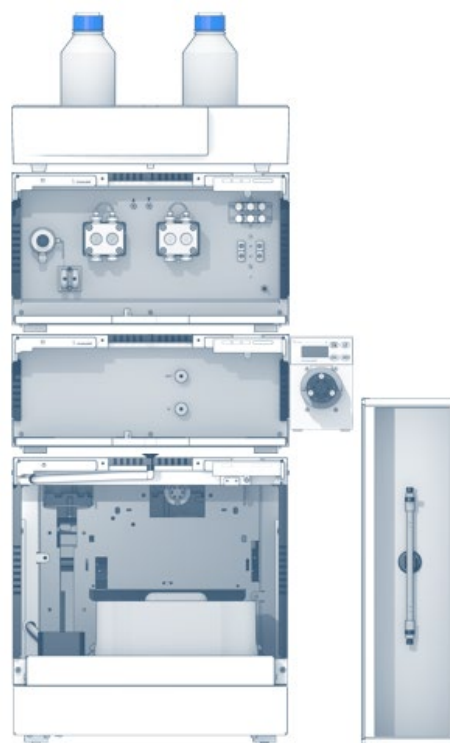
Column temperature	75 °C
Injection volume	20 µL
Injection mode	Partial loop
Detection	RID
Data rate	20 Hz
Time constant	0.05 s

**Tab. 3** System configuration

Instrument	Description	Article No.
Pump 1	AZURA P6.1L, HPG	<a href="#">APH35EA</a>
Autosampler	AZURA AS 6.1L	<a href="#">AAA00AA</a>
Detector	AZURA RID 2.1L	<a href="#">ADC01</a>
Thermostat	AZURA CT 2.1	<a href="#">A05852</a>
Valve drive	AZURA VU 4.1	<a href="#">AWA01</a>
Valve	High-pressure injection valve, 8 Port	<a href="#">AVC38AC</a>
Column 1	Eurokat Na, 300 x 8 mm ID	<a href="#">30GX210EKN</a>
Column 2	Eurokat Ca, 300 x 8 mm ID	<a href="#">30GX360EKN</a>
Software	ClarityChrom 8.1 - workstation, autosampler control included	<a href="#">A1670</a>

**Tab. 2** Pump parameters

Eluent (A)	Water
Flow rate	0.5 mL/min
Gradient	isocratic



## RELATED KNAUER APPLICATIONS

[VFD0150](#) - Xylitol Extraction via HPLC Purification from Fermented Biomass

[VFD0160](#) - Determination of sugars and natural sugar substitutes in different matrices

[VFD0148J](#) - Determination of mannose and manno oligosaccharides with an improved RI detector

# HILIC - Sugars and fructooligosaccharide analysis



Juliane Böttcher, Kate Monks; applications@knauer.net

KNAUER Wissenschaftliche Geräte GmbH, Hegauer Weg 38, 14163 Berlin; www.knauer.net

Marcel Hoevels, Franziska Wienberg

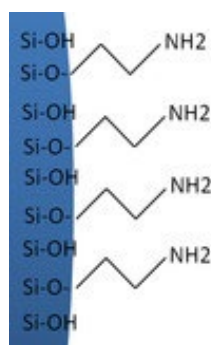
Universität Bonn, AG Prof. Dr. Deppenmeier, Institut für Mikrobiologie und Biotechnologie (IfMB)

## SUMMARY

The determination of carbohydrates can sometimes be challenging. Not all columns are able to separate monomers, dimers, and oligomers at the same time. The KNAUER Eurospher II Amino (NH<sub>2</sub>) phase applied in hydrophilic interaction liquid chromatography (HILIC) mode can solve this task. Even carbohydrates with a high degree of polymerization (DP) can be separated.

## INTRODUCTION

Sugar or carbohydrate analysis is often performed using polymer columns or special stationary phases with ligand exchange and/or size exclusion mechanism. But the run time of those measurements can be very long, depending on the degree of polymerization (DP) that should be analysed. The use of NH<sub>2</sub> columns allows faster methods and takes advantage of completely different interactions between analyte and stationary phase. Amino bonded silica gel phases can be used ideally in the normal phase and hydrophilic interaction liquid chromatography (HILIC) mode. They show alternative normal phase selectivity to unbonded silica, especially for aromatics. Amino columns can also be used in the HILIC mode for carbohydrate analysis and for other polar compounds. Typically, the amino group is bonded to the silica support via a propyl linker and the phases are often non endcapped (**Fig. 1**). HILIC is a technique that uses a polar stationary phase in conjunction with a mobile phase containing an appreciable



**Fig. 1** Abstracted illustration of a bonded amino group to silica.

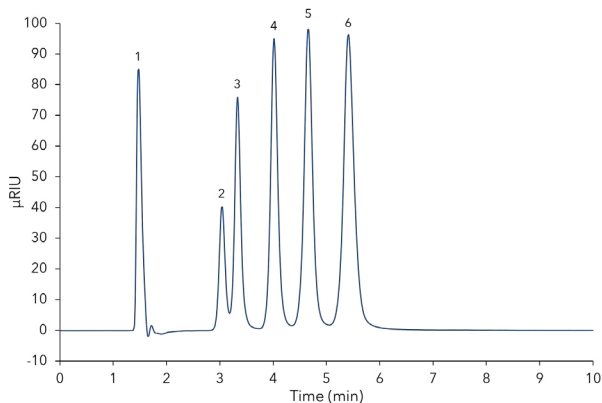
quantity of water combined with a higher proportion of a less polar solvent (often acetonitrile). Most commonly, separations are carried out using 5 to 40% water (or aqueous buffers)<sup>1</sup>. HILIC provides an alternative approach to effectively separate small polar compounds on polar stationary phases.



# HILIC - Sugars and fructooligosaccharide analysis

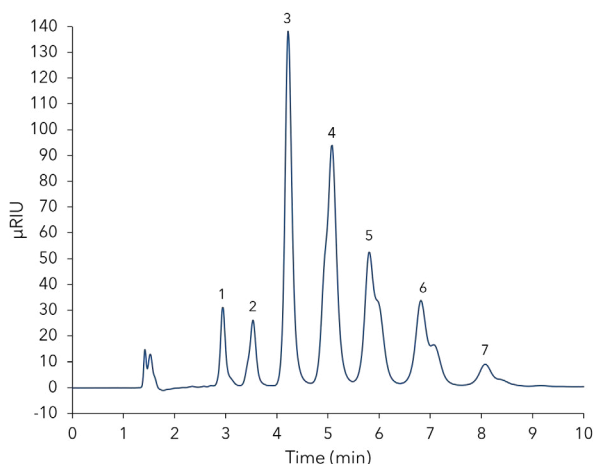
## RESULTS

The detailed method parameters are described in the material and methods section. The shown data and method were recorded and provided by the group of Prof. Dr. Uwe Deppenmeier from the Institute for Microbiology and Biotechnology (IfMB), University of Bonn<sup>2</sup>. Samples with different complexity were measured, from low degree of polymerization up to DP17. **Fig. 2** shows a sugar and inulin-type fructooligosaccharide (FOS) standard at a concentration of 2.50 mM for each compound. The isocratic separation is achieved in under eight minutes. Except for glucose and sucrose, all peaks are baseline separated and can be quantified if requested.



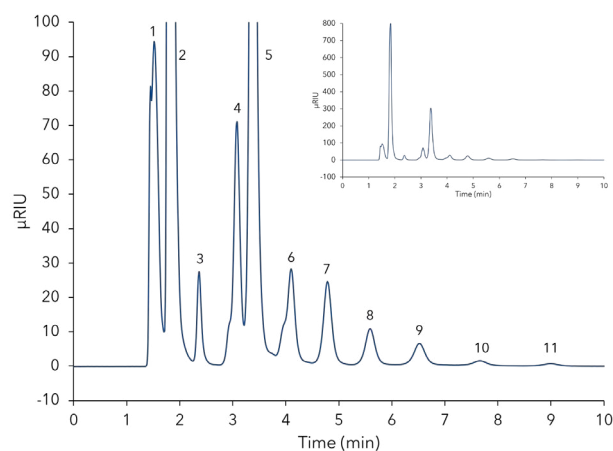
**Fig. 2** Chromatogram of sugar and inulin-type FOS standard, 2.50 mM. 1 - injection peak, 2 - glucose, 3 - sucrose, 4 - 1-kestose, 5 - 1,1-kestotetraose, 6 - 1,1,1-kestopentaose.

**Fig. 3** shows a sample of FOS from chicory with DP2 to DP7. The sample concentration was 50 mM.



**Fig. 3** Chromatogram of FOS from chicory, 50 mM. 1 - fructose, 2 - DP2, 3 - DP3, 4 - DP4, 5 - DP5, 6 - DP6, 7 - DP7.

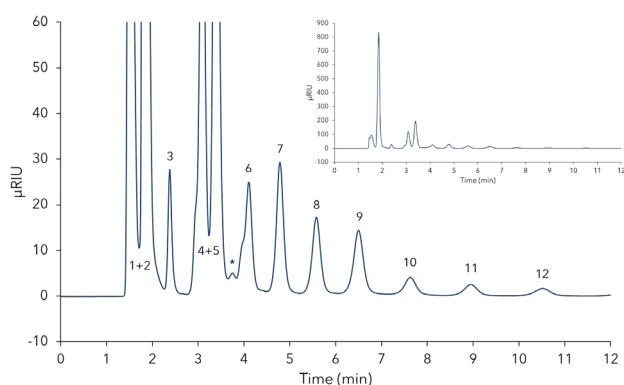
Furthermore, inulin-type FOS samples generated by bacterial inulosucrase were determined. The goal is to transfer the raw material (sucrose) almost completely (> 90%) and then interrupt the reaction. The duration of the synthesis is dependent on the amount of used protein and sucrose<sup>2</sup>. The measured samples were taken at three different times of the process: after 0.5 hours, 1 hour and 6 hours. The following figures display the original chromatograms (right top corner) and an enhanced view of the same measurement to illustrate the smaller peaks of the substances with a high DP. **Fig. 4** shows the sample after 0.5 hours of the FOS generation process. Peak four has a little shoulder at about 2.95 minutes, which is fructose.



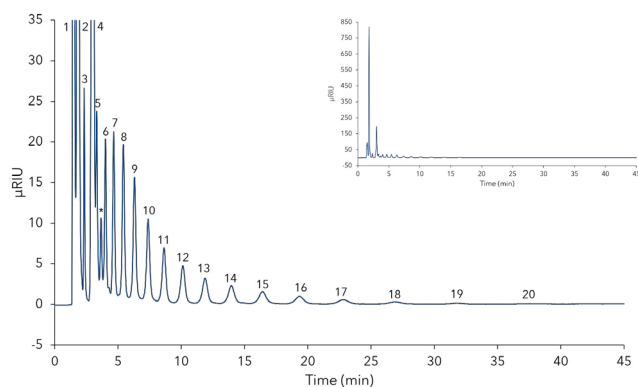
**Fig. 4** FOS generated from bacterial inulosucrase after 0.5 hours. 1 - injection peak, 2 - sample matrix, 3 - glycerol, 4 - glucose, 5 - sucrose, 6 - DP3, 7 - DP4, 8 - DP5, 9 - DP6, 10 - DP7, 11 - DP8.

**Fig. 5** and **Fig. 6** show the sample after 1 and 6 hours of the FOS generation process. Within half an hour of the enzymatic reaction carbohydrates up to DP9 were produced, compared to **Fig. 4**. Between peak five and six a small peak is visible. This is an unidentified substance occurring in the synthesis process (**Fig. 5**). Also, an intermediate sample was measured after 4 hours but there was no significant difference to the sample after 6 hours (**Fig. 6**).

## RESULTS



**Fig. 5** FOS generated from bacterial inulosucrase after 1 hour. 1 - injection peak, 2 - sample matrix, 3 - glycerol, 4 - glucose, 5 - sucrose, 6 - DP3, 7 - DP4, 8 - DP5, 9 - DP6, 10 - DP7, 11 - DP8, 12 - DP9, \* - unidentified substance.



**Fig. 6** FOS generated from bacterial inulosucrase after 6 hours. 1 - injection peak, 2 - sample matrix, 3 - glycerol, 4 - fructose/glucose, 5 - sucrose, 6 - DP3, 7 - DP4, 8 - DP5, 9 - DP6, 10 - DP7, 11 - DP8, 12 - DP9, 13 - DP10, 14 - DP11, 15 - DP12, 16 - DP13, 17 - DP14, 18 - DP15, 19 - DP16, 20 - DP17, \* - unidentified substance.

## SAMPLE PREPARATIONS

The concentration of the analytes in standards and samples lay in a range from 0.2 up to 50 mM. The samples/standards were diluted with acetonitrile:water mixtures. Dependent on the eluent

used in the method, it was tried to keep the acetonitrile concentration as near as possible to the starting conditions of the method<sup>2</sup>.

## CONCLUSION

The benefits of carbohydrate analysis with amino stationary phase in HILIC mode clearly lies in the run time. The KNAUER Eurospher II NH2 stationary phase achieves an outstanding separation for the fructooligosaccharide samples as well as for samples with lower DPs. Therefore it is perfectly suited for this type of analysis. In about 15 minutes it is possible to determine complex samples with a degree of polymerization up to DP11 (**Fig. 6**). By extending the run time even the analysis of samples with DP17 or more is possible.

## MATERIALS AND METHODS

**Tab. 1** Method parameters

Column temperature	40 °C
Injection volume	20 µl
Injection mode	Partial loop
Detection	Refractive index
Data rate	20 Hz

**Tab. 2** Pump parameters

Eluent (A)	Acetonitrile:water 60:40 (v/v)
Flow rate	0.6 ml/min
Gradient	Isocratic

**Tab. 3** System configuration

Instrument	Description	Article No.
Pump	Thermo SpectraSYSTEM P4000	-
Degasser	Thermo SpectraSYSTEM SCM1000	-
Autosampler	Thermo SpectraSYSTEM AS3000	-
Detector	Shodex RI-101	-
Thermostat	N/A	-
Column	Eurospher II 100-5 NH <sub>2</sub> , 250 x 3 mm ID with precolumn	<a href="#">25XE190E2J</a>

## REFERENCES

- [7] McCalley, D. V. Hydrophilic interaction chromatography. <http://www.chromatographyonline.com/hydrophilic-interaction-chromatography-0> (2008).
- [8] University of Bonn, Group of Prof. Dr. Uwe Deppenmeier, Institute for Microbiology and Biotechnology (IfMB).

## RELATED KNAUER APPLICATIONS

[VFD0105J](#) - Separation of fructooligosaccharides

[VFD0120J](#) - Separation of maltooligosaccharides by HILIC

[VFD0161](#) - Determination of sugar in honey using HILIC separation and RI detection



# Streamlining of equipment: Hybrid system for preparative and analytical LC

Lisa Loxterkamp, Johannes Menke, Kate Monks; applications@knauer.net  
KNAUER Wissenschaftliche Geräte GmbH, Hegauer Weg 38, 14163 Berlin; www.knauer.net.



## SUMMARY

When separating and purifying molecules by liquid chromatography (LC), it is necessary to develop the method with a preparative high-performance liquid chromatography (HPLC) system. The purification process is often verified for quality and quantity of the products by analytical HPLC. In this case, two LC systems, a preparative and an analytical, are needed for a purification process and the following analysis. In this technical note a combination of these two systems is shown. It describes in detail the system set up and the different method steps. The system is capable of isolating a single substance from a mixture and afterwards performing an automated purity analysis. For proof of concept, caffeine was purified from paracetamol and analysed within the same system.

## INTRODUCTION

Looking at the major cost generated by chromatography separation techniques, hardware costs are besides the stationary and mobile phase an important factor<sup>1</sup>. Especially in the preparative field, where high flow rates are applied, the eluent costs are not to be neglected. Reducing these costs by combining two systems into one can be beneficial. Another advantage for streamlining systems is the time saved by automating the process. Especially if the process is repetitive, the methodical effort is worthwhile. The aim is to establish a combination of semi-preparative purification in the flow rate range up to 50 ml/min with simultaneous analytical qualification and quantification in one system using the same chromatography software suite. This combination

was carried out with the new KNAUER assistant ASM 2.2L, a modular docking station combining several valves. With two multi-position 6 port valves, up to three different columns can be used in this system to perform a method development or to purify different compounds in a semi-preparative scale. With two injection valves, sample introduction for preparative or analytical purposes can be introduced in the system separately. The purification step is carried out with a KNAUER VariLoop L, where up to 40 ml sample can be stored. The VariLoop is a storage container which can be filled in only one direction and drained in the opposite direction. The two sites are separated by an integrated pressure valve passing eluent in one direction for flushing.



# Streamlining of equipment: Hybrid system for preparative and analytical LC

## INTRODUCTION

Its purpose is to separate a flexible amount of volume without mixing the fraction further with eluent. For eluent delivery a KNAUER P6.1L HPG pump with 50 ml pump head was used. A multi-wavelength UV detector with a pressure proof 10 µl flow cell with 10 mm path length was used for detection. Within this work a KNAUER Eurospher C18 150x20 mm ID preparative column with 10 µm particle size was used for the example

## RESULTS

In Fig. 1 the flowpath of the system and the different valve positions are shown and described. The system flow starts from the bottom at the P 6.1L and passes through the first ASM 2.2L towards the columns followed by the MWD 2.1L. Depending on the VariLoop load valve setting the sample goes either to waste or is collected in the VariLoop for fractionation and analysis.

separation of caffeine and paracetamol. For the analytical verification of the caffeine content the Eurospher C18 150x4 ID with 5 µm particle size was used. For system control ClarityChrom 8.2 was employed. The established system shown here, can support the first stages for optimization of the method as well as scale up for the process with different column dimensions<sup>2</sup>.

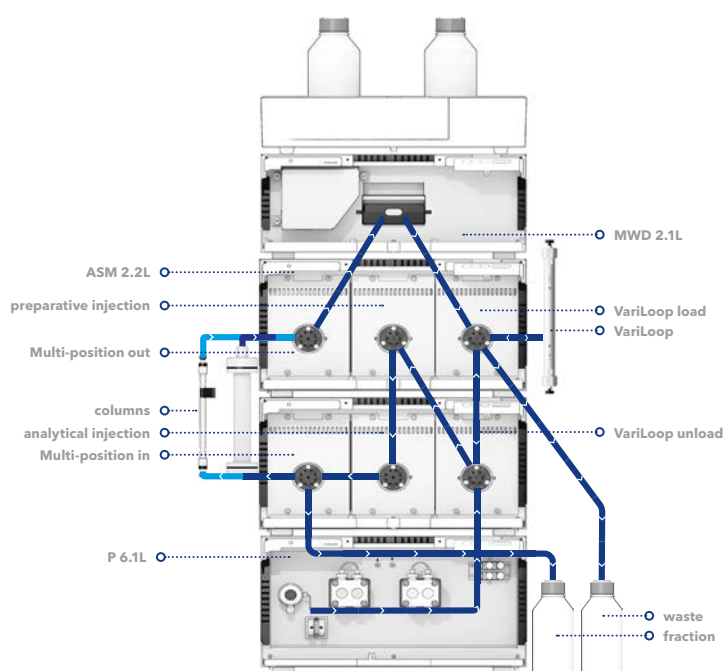


Fig. 1 The used system with the different components and modules.

**VariLoop unload:** A 2-position 6 port valve is delivering eluent towards the columns in position 2 and unloads the VariLoop in position 1.

**Preparative Injection:** A 2-position 6 port valve is used for preparative injection where position 1 loads the sample and position 2 injects it.

**Analytical injection:** A 2-position 8 port valve, contains two similar loops and loads the sample in position 2 and injects it in position 1 in the manual injection method. During the continuous run, position 1 is default and position 2 loads the sample in the other loop.

**Multi-position in** is marked as the multi-position 6 port valve where position 1 is connected to the bypass. Position 4 is the analytical and position 5 is the preparative column. Additionally position 2 leads to the waste and position 3 is for fractioning. The two multi-position valves are switched simultaneously.

**Multi-position out** is marked as the multi-position 6 port valve where position 1 is connected to the bypass. Position 4 is the analytical and position 5 is the preparative column. The two multi-position valves are switched simultaneously.

**VariLoop load:** A 2-position 6 port valve is loading the 40 ml VariLoop in position 1 and unloading it in position 2.

## RESULTS

The purification and analysis were divided into six methods:

**Step 0** - „Scouting“ is intended for determining the fractionation time of the target component.

**Step 1** - „Purification“ represents the actual purification step in which the sample is separated on the preparative column and the target fraction collected into the VariLoop.

**Step 2** - „Unload“ unloads the target fraction from the VariLoop into the desired storage container. Meanwhile an aliquot is taken and filled into the analytical sample loop.

**Step 3** - „Equilibration“ is the equilibration of the analytical system and column.

**Step 4** - „Analysis“ is the actual analysis of the stored fraction aliquot in the analytical loop.

**Step 5** - „Manual analysis“ is the manual injection of the fraction or can be used when quantifying the sample after the original run. All method parameters are documented in the „Materials and Methods“ part.

Combining the above mentioned methods and valve positions, **Fig. 2** shows an overview of the given system flow. The valve changing process is documented in a video (**see QR code below**). The detailed time switching valve positions are documented in the tables in chapter „Materials and methods“.

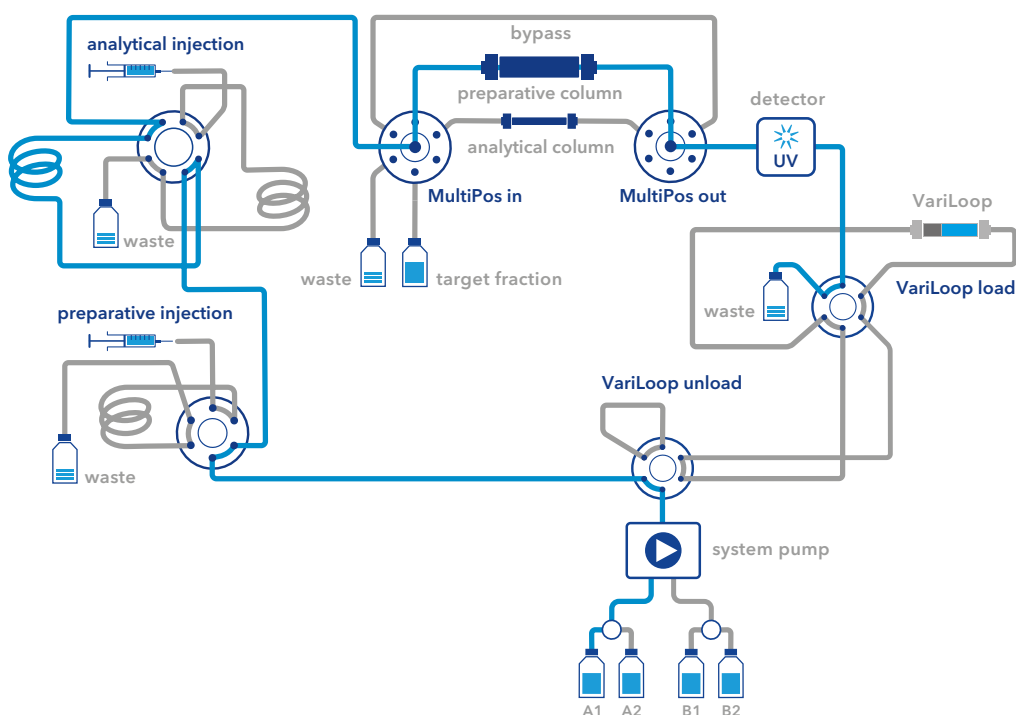


Fig. 2 Flowchart overview for the scouting and purification step.



[youtu.be/vRuVUJSP010](https://youtu.be/vRuVUJSP010)

# Streamlining of equipment: Hybrid system for preparative and analytical LC

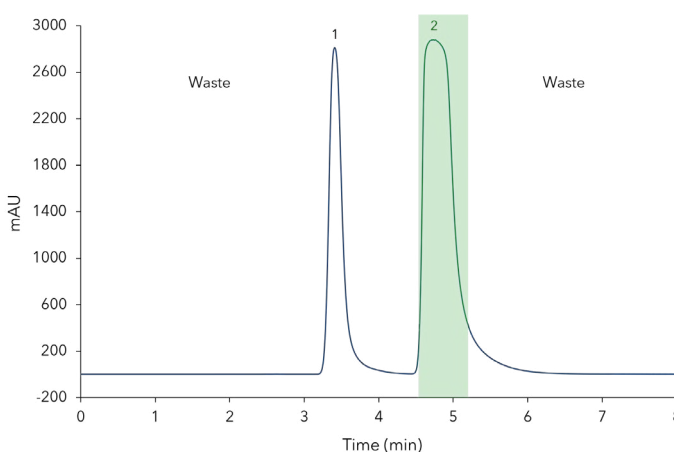
## SAMPLE PREPARATIONS

**Sample preparation:** 101.5 mg paracetamol and 148.6 mg caffeine were dissolved in a 10 ml volumetric flask containing 20:80 ethanol/water (v/v). After complete dissolution, 20% ethanol was added to the mark and the sample was filtered through a 0.45 µm RC filter. The solution corresponded to a concentration of 10.15 mg/ml paracetamol and 14.86 mg/ml caffeine. This solution was used for the purification experiments. For the calibration 14.2 mg caffeine were dissolved in a 10 ml volumetric flask with 20% EtOH. After complete dissolution, 20% EtOH was added to the mark and the sample was filtered through a 0.45 µm RC filter. From this stock solution 1 ml was diluted to 10 ml with 20% EtOH (calibration level L3). For calibration level L2, 0.5 ml of the stock solution was diluted to 10 ml 20% EtOH. For calibration level L1, 100 µl of the stock solution were diluted to 10 ml 20% EtOH. The resulting concentrations are shown in **Tab. 1**.

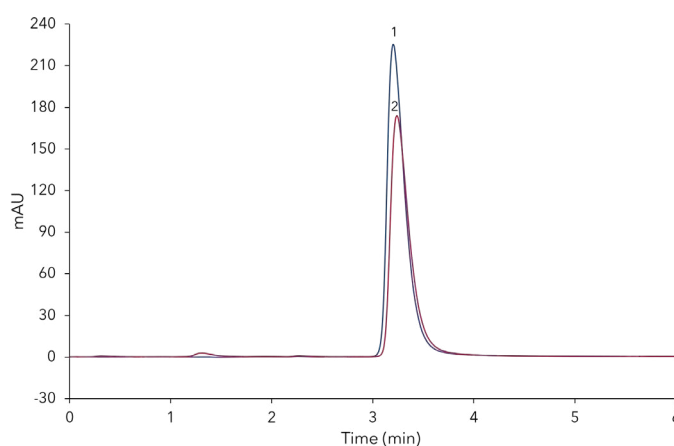
**Tab. 1** Calibration dissolution, concentration stock solution 1.42 mg/ml

Calibration level	Dilution ratio	Concentration (µg/ml)
L1	1:100	14.2
L2	1:20	71.0
L3	1:10	142.0

**Fractioning and calibration:** In **Fig. 3** the chromatogram shows the two signals of paracetamol and caffeine with the given fractionation window backed green. **Fig. 4** compares the area of caffeine with the automated and manual analysis of the fraction. During the manual fraction analysis, carry-overs were detected which disappeared after three blank injections. At low concentrations of the analyte, the effect is less pronounced and one blank injection between each analyte injection is sufficient.



**Fig. 3** Step 1 Purification with fractionation window (green), 50 µl injection, 15 ml/min flow. 1 - Paracetamol, 10 mg/ml; 2 - Caffeine, 15 mg/ml.

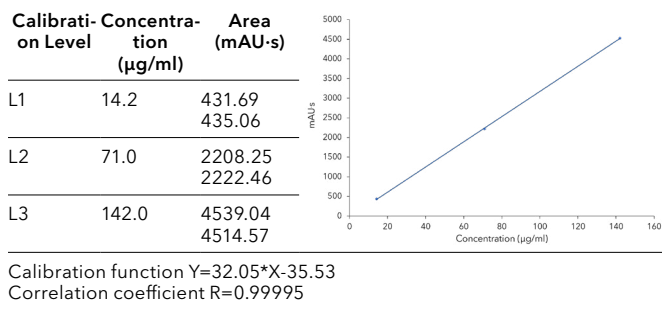


**Fig. 4** 1 - Step 4 Automated analysis, 10 µl injection, 1 ml/min flow, caffeine area: 2807,6 mAU·s. 2 - Step 5 Manual analysis of the fraction from Fig. 2, 10 µl injection, 1 ml/min flow, caffeine area: 2283,6 mAU·s.

**Fig. 5** and **Tab. 2** show the results of the calibration compared to the measured samples. The comparison of the automated fraction analysis of step 4 and the manual fraction analysis of Step 5 shows a caffeine concentration of 88.7 µg/ml to 72.4 µg/ml or 2807.6 mAU·s to 2283.6 mAU·s. The originally added concentration of caffeine corresponded to an absolute concentration of 82.6 µg/ml (15.2 mg/ml caffeine sample, 50 µl injection volume and 9.2 ml VariLoop fraction volume). The L1 standard with 10 µg/ml showed a signal-to-noise ratio of about 120 (peak height: 33.6 mAU, noise (ASTM) 0.2811 mAU (from 0.4-2.8 min)).

## SAMPLE PREPARATIONS

Tab. 2 Calibration results



## CONCLUSION

It is possible to combine a semi-preparative purification of paracetamol and caffeine with simultaneous qualification of the fraction within 26 minutes. Furthermore, additional manual injections for the analytical determination can be performed using an 8 port 2-position injection valve with two similar loops. This allows a direct quantification of different samples independent from the collected fraction. The collected caffeine fraction in the analytical loop at step 4 shows a higher concentration of 88.7 µg/ml than the manual determination in step 5 with 72.4 µg/ml. Taking into account that only a time window of six seconds was used for analytical sampling, the sample is representative. Compared to the absolute injection concentration of 82.6 µg/ml, the step 4 sample with 88.7 µg/ml is higher. This might indicate that the fraction was not sufficiently mixed in the VariLoop, thus resulting in an inhomogenous concentration distribution. When injecting manually, it can be assumed that the mixing in the fraction container was complete. Since the fraction (40 s fraction collection to 1.2 min peak width) does not contain the complete caffeine peak either, the concentration of 72.4 µg/ml seems more realistic. In percentage terms this corresponds to approximately 88% of the initial concentration. Nevertheless, the sample is diluted during the preparative run. Previously, overloading with caffeine resulted in a signal intensity of

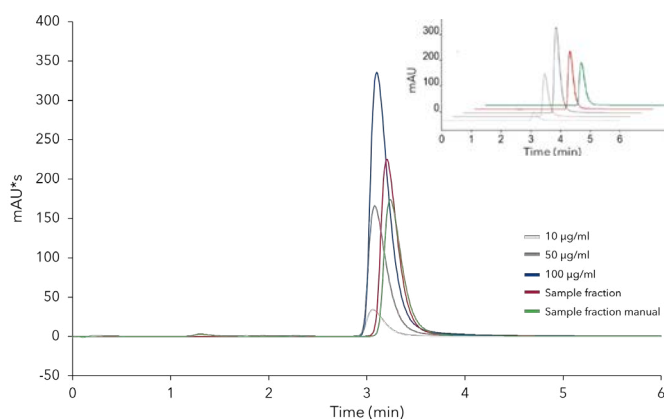


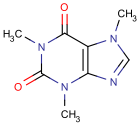
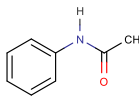
Fig. 5 Calibration standards compared to samples.

2 500 mAU compared to the approximately 200 mAU of the analytical determination. This ten times signal dilution of the analytical run must be considered when lower sample concentrations are injected at the beginning. The two multi-position 6 port valves have one additional port to use with another column to test different purification methods. It is also possible to switch to 8 or 16 multi-positions valves. With the HPG pump it is possible to connect four different eluents, which makes flexible solvent choice and method development possible. However, the flow rate should be checked in the small flow range of less than 1 ml/min. Using flow rates below 1 ml/min the solvents should be mixed beforehand if necessary. Otherwise, insufficient mixing and thus strong baseline fluctuations are to be expected. A maximum pressure of 300 bar restricts the system on an analytical scale in the choice of particle size. In this case a stationary phase material with 5 µm particle was used instead of a 3 µm particle, to prevent high back pressure. The valve control with ClarityChrom 8.2 is time based and therefore needs to be adapted according to every change in the system, otherwise back pressures from over 300 bar can occur easily. Taking into account these limitations a preparative purification with subsequent analysis of the purified product can be automated within one HPLC system to save time and resources.

# Streamlining of equipment: Hybrid system for preparative and analytical LC

## MATERIALS AND METHODS

Tab. 3 Analytes

Analyte	CAS#	Structure
Caffeine	58-08-2	
Paracetamol	103-90-2	

Tab. 4 Method

Column temperature	ambient
Injection mode	Manual injection
Detection	UV 273 nm
Data rate	10 Hz

### Step 1 - Purification

#### Flow and injection

Flow rate	15 ml/min	Sample injection	50 µl
-----------	-----------	------------------	-------

#### Gradient program

Time (min)	Eluent A, Water (%)	Eluent B, Ethanol (%)
0-8	20	80

#### Valve position

Time (min)	MultiPos out	Preparative injection	VL load	Comments
Initial	4	1	2	Switch to prep column
0.02	4	2	2	Inject
4.50	4	2	1	Start filling VL
5.15	4	2	2	Stop filling VL
7.70	4	1	2	Back to default

Time	MultiPos in	Analytical injection	VL unload	Comments
Initial	4	1	2	Switch to prep column

### Step 2 - Unload

#### Flow and injection

Flow rate	10 and 20 ml/min	Sample injection	n.a.
-----------	------------------	------------------	------

#### Gradient program

Time (min)	Eluent A, Water (%)	Eluent B, Ethanol (%)	Flow rate (ml/min)
0	20	80	0
0.10	20	80	0
0.12	20	80	10
1.04	20	80	10
1.06	20	80	20
1.98	20	80	20
2.00	20	80	0
2.20	20	80	0

#### Valve position

Time	MultiPos out	Preparative injection	VL load	Comments
Initial	5	1	2	Default
0.02	3	1	2	Go to release position
1.04	2	1	2	Go to waste, clean system
2.10	5	1	2	Switch to analytical method

Time	MultiPos in	Analytical injection	VL unload	Comments
Initial	5	1	2	Default
0.02	3	1	2	Go to release position
0.04	3	1	1	Send flow to VL
0.64	3	2	1	Fill analytical loop
0.74	3	1	1	Analytical loop to bypass
1.12	2	1	1	Go to waste
2.10	5	1	2	Switch to analytical method

## MATERIALS AND METHODS

### Step 3 - Equilibration

#### Flow and injection

Flow rate	1&20ml/min	Sample Injection	n.A.
-----------	------------	------------------	------

#### Gradient program

Time [min]	Eluent C, Water (80 %), Ethanol (20%)	Flow rate (ml/min)
Initial	100	0
0.28	100	0
0.30	100	20
3.00	100	20
3.02	100	0
3.20	100	0
3.22	100	1
10.00	100	1

#### Valve position

Time	MultiPos out	Preparative injection	VL load	Comments
Initial	5	1	2	Initial
0.10	1	1	2	Bypass
3.10	5	1	2	Switch to analytical column

Time	MultiPos in	Analytical injection	VL unload	Comments
Initial	5	1	2	Initial
0.10	1	1	2	Bypass
3.10	1	1	2	Switch to analytical column

### Step 4 - Analysis

#### Flow and injection

Flow rate	1 ml/min	Sample injection	10 µl (stored in analytical loop)
-----------	----------	------------------	-----------------------------------

#### Gradient program

Time (min)	Eluent A, Water 80 (%), Eluent B, Ethanol (20 %)
0-6	100

#### Valve position

Time	MultiPos out	Preparative injection	VL load	Comments
Initial	5	1	2	Go to analytical column

Time	MultiPos in	Analytical injection	VL unload	Comments
Initial	5	1	2	Go to analytical column
0.02	5	2	2	Inject sample
5.96	5	1	2	Analytical bypass

### Step 5 - Manual Analysis

#### Flow and injection

Flow rate	1 ml/min	Sample injection	10 µl
-----------	----------	------------------	-------

#### Gradient program

Time (min)	Eluent A, Water 80 (%), Eluent B, Ethanol (20 %)
0-6	100

#### Valve position

Time	MultiPos out	Preparative injection	VL load	Comments
Initial	5	1	2	Go to analytical column

Time	MultiPos in	Analytical injection	VL unload	Comments
Initial	5	2	2	Load sample
0.02	5	1	2	Inject sample
5.96	5	2	2	Back to default

## MATERIALS AND METHODS

Tab. 5 System configuration

Instrument	Description	Article No.
Column	Preparative column, Eurospher II 100-10 C18, column 150x20 mm	<a href="#">15JE181E2N</a>
Column	Analytical column, Eurospher 100-5 C18 with precolumn, column 150x4 mm	<a href="#">15WE181ESJ</a>
Preparative sample loop	40 ml KNAUER VariLoop L for 1/16" tubings	<a href="#">A1055-1</a>
Software	ClarityChrom 8.2 - Workstation, autosampler control included	<a href="#">A1670</a>
Detector	AZURA Detector MWD 2.1L, 190-700 nm, multiwavelength detector	<a href="#">ADB01</a>
Flow cell	Analytical KNAUER PressureProof UV flow cell cartridge	<a href="#">AMC38</a>
Pump	AZURA P 6.1L high pressure pump with 50 ml pump head, stainless steel, without degasser	<a href="#">APH38FA</a>
Assistant top	AZURA Assistant ASM 2.2L	<a href="#">AY00552</a>
Valve drive (left) (Multiposition out)	AZURA V 4.1 Valve with multiposition valve, 6 Port, sst, 1/16", 500 bar, 0.75 mm bore size	<a href="#">AVS26AE</a>
Valve drive (middle) (Preparative injection)	AZURA V 4.1 Valve with 2-position valve, 6 Port, sst, 1/16", 500 bar, 0.75 mm bore size	<a href="#">AVD26AE</a>
Valve drive (right) (VariLoop load)	AZURA V 4.1 Valve with 2-position valve, 6 Port, sst, 1/16", 500 bar, 0.75 mm bore size	<a href="#">AVD26AE</a>
Assistant bottom	AZURA Assistant ASM 2.2L	<a href="#">AY00552</a>
Valve drive (left) (Multiposition in)	AZURA V 4.1 Valve with multiposition valve, 6 Port, sst, 1/16", 500 bar, 0.75 mm bore size	<a href="#">AVS26AE</a>
Valve drive (middle) (Analytical injection)	AZURA V 4.1 Valve with 2-position valve, 8 Port, DLC, sst, 1/16", 500bar, 0.75 mm bore size	<a href="#">AVD36AE</a>
Valve drive (right) (VariLoop unload)	AZURA V 4.1 Valve with 2-position valve, 6 Port, sst, 1/16", 500 bar, 0.75 mm bore size	<a href="#">AVD26AE</a>

## REFERENCES

- [9] Schmidt-Traub, H., Schulte, M., Seidel-Morgenstern, A. Preparative Chromatography (second edition). Wiley-VCH Verlag & Co. KGaA. (2012).
- [10] Aldington, S., Bonnerjea, J. Scale-up of monoclonal antibody purification processes. Journal of Chromatography B, 15;848(1):64-78 (2007).



# Simulated Moving Bed (SMB) inline sampling

Svea Stephan, Yannick Krauke, Paul Pietsch, Kate Monks; applications@knauer.net  
KNAUER Wissenschaftliche Geräte GmbH, Hegauer Weg 38, 14163 Berlin; www.knauer.net.

## SUMMARY

During the development of a SMB method, it is helpful to determine the concentration profiles in the four SMB zones. An inline sampling was established in addition to the sampling at the extract and raffinate outlet. Therefore, a manual injection valve was implemented as sampling valve before the inlet of column 1 in the AZURA lab SMB system. With this setup a separation method of paracetamol and caffeine was optimized, and samples were taken in all four zones. The resulting concentration profiles help optimizing the method.

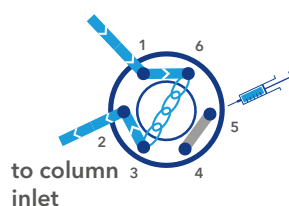
## INTRODUCTION

In the development process of a SMB method it is necessary to determine the target substances in extract and raffinate. As the complexity of the SMB process is higher than the classical batch process, the development of the method comes with higher demands on process design and control. One way of monitoring the SMB process is the collection of both raffinate and extract for one switch or a whole cycle and determination of target substance distribution. This process is easily applied in small, lab-scale SMB processes and helpful for SMB method development (Rev. 1: TechNote [VTN00012](#)). This approach is more challenging in larger scale SMB as the volumes of the two outlets will significantly increase and sample taking could be more difficult due to constructional reasons. Another way of monitoring the SMB process is the inline sampling. Here, a sample is taken at a defined time point between two switches. For this inline sampling, a valve is implemented before

the inlet of one column and it will be moved through the system with that column, see [Fig. 1](#). With this valve a sample of the stream can be taken. This enables the composition of the liquid phase at one point of every switch and in all four zones to be determined.

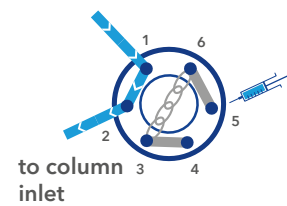
### Pos. 1

capillary to column

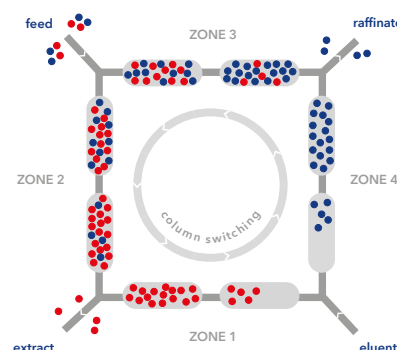


### Pos. 2

capillary to column



**Fig. 1** Operation mode of the valve for the inline sampling (6-port 2-position).

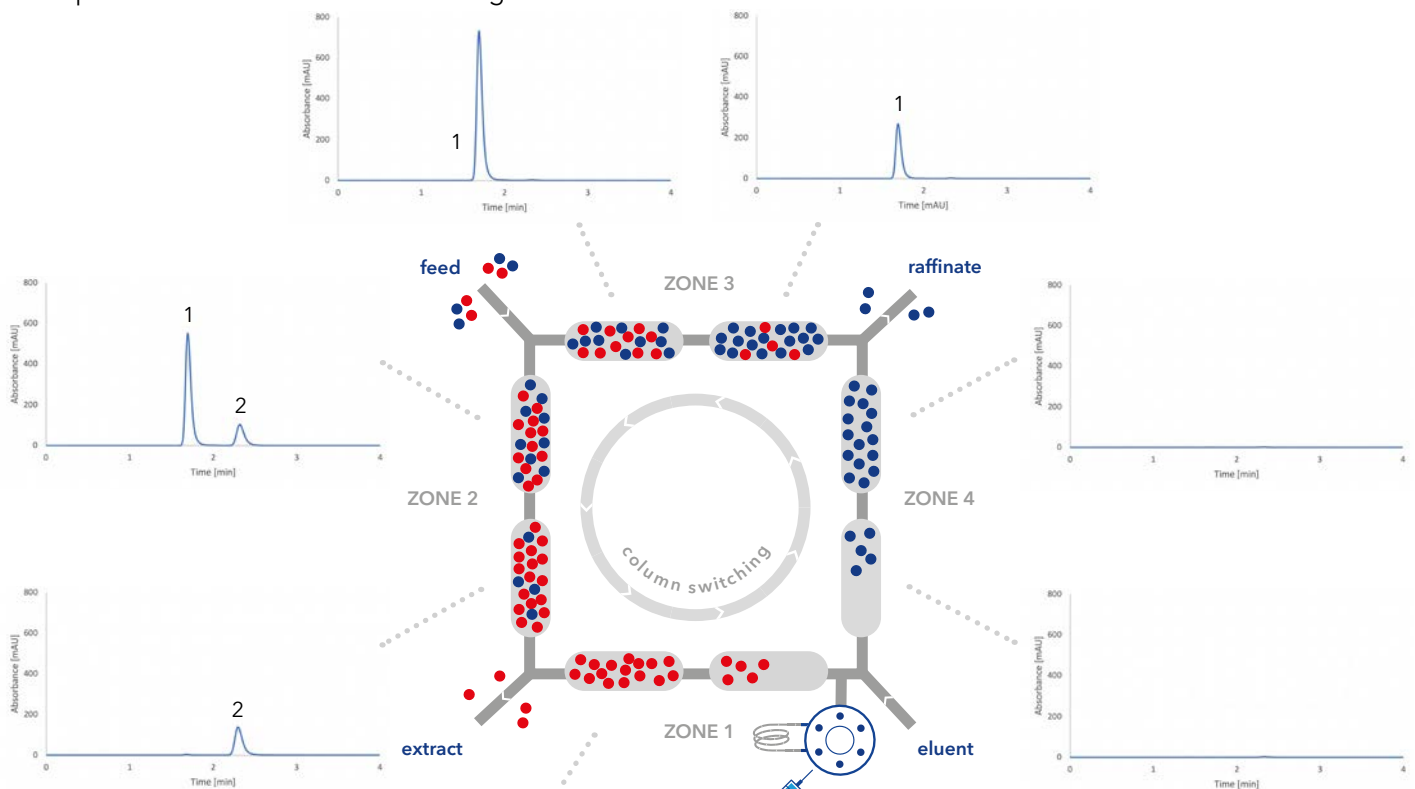


# Simulated Moving Bed (SMB) inline sampling

## RESULTS

The manual valve was integrated in the flow path before the inlet of column 1. The operation mode of the valve is shown in **Fig. 1**. The used SMB set-up was a 2:2:2:2 configuration with two columns in each of the four zones (**Fig. 2**). An SMB process for the optimization of caffeine and paracetamol separation was run for ten cycles to reach a steady state. In the eleventh cycle samples were taken in the middle of the separation time between two switches. **Fig. 2** shows the SMB system setup with two columns in every zone. Chromatograms are positioned at the corresponding position of the flow path. The chromatograms and the corresponding position in the system help finding possibilities to optimize the method. The chromatograms in zone 4

show that both columns do not contain any raffinate. Additional to that no extract enters zone 3. This indicates that there is still room for improvement regarding the effectiveness of the separation. Higher flow rates in zone 2 and 3 could lead to a better performance of the system. Further, a higher feed flow rate could be realized and thus increase the productivity of the process. During cycle 14 two samples were taken between two switches, the first sample after 0.5 min and the second sample after 1.5 min. In **Fig. 3** the resulting concentration profile of paracetamol and caffeine is shown. This overview also shows the potential areas of improvement regarding the SMB process.

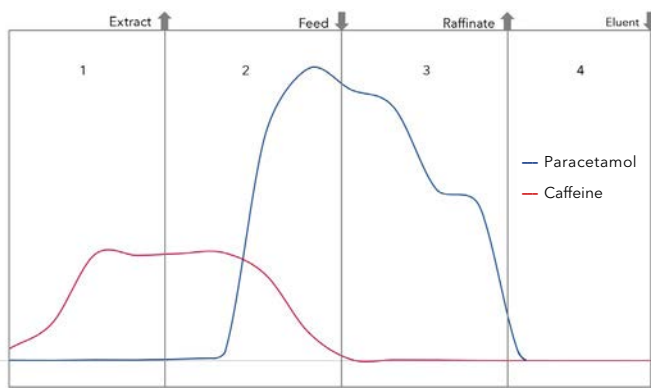


**Fig. 2** SMB chromatography principle in 2:2:2:2 configuration with corresponding chromatograms of the samples taken by the inline valve between each switch: paracetamol (1 - blue) and caffeine (2 - red).

## SAMPLE PREPARATIONS

In the beginning of the sampling the sample valve (Fig. 1) is in position 2 and the sample loop is implemented in the flow path. At the time of sampling the valve is switched manually to position 1. The switching

must happen very fast to prevent high back pressure. With a syringe the liquid is pushed out of the loop into a sample vial. Then the loop is filled with eluent before it is switched back into the flow.



**Fig. 3** Concentration profile of paracetamol and caffeine in the 4 SMB zones.

## CONCLUSION

The inline sampling facilitates the process of sample taking during the SMB method development tremendously. Compared to samples taken from the outlets, the sample volume is much smaller as it only depends on the size of the sample loop used in the valve. It is possible to take samples at different points in the flow path and to gain knowledge of the concentration profiles of the two target substances in all four zones. This fastens the process of developing and optimizing a new SMB method.

## MATERIALS AND METHODS

Tab. 1 Method parameters

	Feed (ml/min)	Eluent (ml/min)
In	0.2	4
Column temperature	ambient	
Cycle time	18.8 min	

Tab. 2 Material

Standard	CAS	Feed concentration (g/l)
Caffeine	58-08-2	1
Paracetamol (Acetaminophen)	103-90-2	6

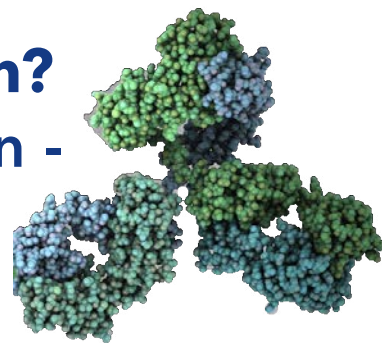
Tab. 3 System configuration

Instrument	Description	Article No.
AZURA lab SMB system	SMB, biocompatible system, lab scale	<a href="#">A29100</a>
Flow meter	3x M13 1x M12	<a href="#">A29800</a> <a href="#">A5394</a>
Column	8x Eurospher II C8 150x8 mm, 100-15, 15 µm	<a href="#">15GE081E2Q</a>
Software	Purity MCC	included in <a href="#">A29100</a>

## RELATED KNAUER APPLICATIONS

[VTN0012](#) - Simultaneous sampling of two product streams

# How to optimize your purification? Your guide for two step purification - principles and system set up



Ulrike Krop, Kate Monks; applications@knauer.net  
KNAUER Wissenschaftliche Geräte GmbH, Hegauer Weg 38, 14163 Berlin; www.knauer.net.

## WHAT IS TWO STEP PURIFICATION?

Two step purification is a special multicolumn chromatography solution. Two independent methods, each with their associated specific column, are used to realize the purification of the target molecule without manual interference. The principle here is that the protein sample is applied on the first column. During elution of

the protein, the protein peak is detected triggering the collection of the eluted protein in a storage loop or storage vessel/container. The protein is then automatically applied on the second column to further enhance the quality and or purity of the purified protein (Fig. 1).

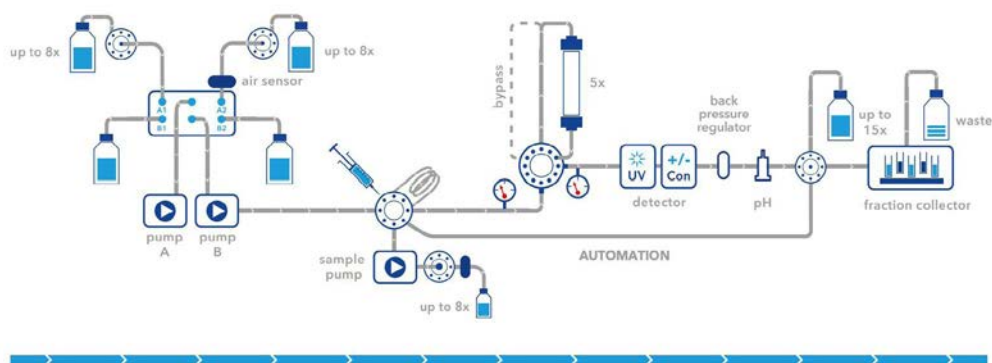


Fig. 1 Example of a typical two step purification system.

## WHY SHOULD I USE TWO STEP PURIFICATION?

For many protein purifications a sequence of different methods is used to achieve pure protein. The protein purification strategy describes the combination of several method steps and divides them into capture, intermediate and polishing step (Fig. 2). The "capture" step purifies the protein from the crude extract. The "intermediate" step removes further contamination, while the aim of the final "polishing" step is to get rid of all remaining impurities to gain

a highly purified product. Depending on the yield and purity of the protein which is needed for further analysis and /or use of the protein, several steps are combined. Nevertheless, purification strategies with just one step or more than three steps are possible as well.



Fig. 2 Purification strategy.



Additional Information

# How to optimize your purification?

## Your guide for two step purification - principles and system set up

### WHICH METHODS CAN I COMBINE?

A two step purification system can easily be used to combine two methods of your purification strategy. A classical approach is the combination of a capture with a polishing step. Some examples for the first and the second step are listed in **Tab. 1**. In principle any method can be combined. Please consider while designing your two step strategy that the elution conditions of the first step should match the starting conditions of the second step. A typical example for

two step purification is the purification of His tagged proteins. The capture step for these proteins is done by immobilized metal ion affinity chromatography. The elution is achieved by imidazole. The next logical step which can be easily integrated in a two step set up is a desalting column to exchange the buffer. Hereby the imidazole is removed, and the ionic strength can be reduced.

**Tab. 1** Overview of methods used for the first and second step of two step purification.

Step	Mode	Method
1. Step	Capture	Tag-affinity (e.g. GST, Strep-Tag) Antibody affinity (e.g. Protein A, Protein G) Immobilized metal ion affinity (IMAC) (e.g. Ni-NTA, Talon) Ion exchange chromatography
2. Step	Intermediate/ Polishing	Size exclusion chromatography Desalting/buffer exchange Ion exchange chromatography Hydrophobic interaction chromatography

### WHAT ARE THE BENEFITS?

The benefits for this set up are manifold. The transition from one to another step generally involves manual interaction and thus is time consuming. Automation by combining these steps increases the efficiency and optimizes the workflow. The quick and automated

linkage of multiple chromatographic purification steps into one method eliminates manual sample handling and minimizes time spent between steps and simple handling errors. This automation strategy can be easily adapted to several purification task.

### WHAT ARE THE SYSTEM REQUIREMENTS AND WHICH SYSTEM SET UPS ARE AVAILABLE?

Several system set ups can be used to automate the purification. Some of the most common set ups are discussed. We will explain in detail the benefits and limitations of each set up. (**Tab. 2**). We assume that the biocompatible multi-injection valve ([AVN94CE](#))

is included within the FPLC system. For all set ups a column selection valve ([AVZ52CE](#)) to select the different columns and an outlet valve ([AVS34CE](#)) to redirect the flow and collect the first peak must be installed in the system.

## BASIC SET UP

In the basic set up a Lab standard KNAUER Multi Method FPLC system for all Bio-Chromatography methods is adapted. Next to the column selection valve and the

outlet valve no other components must be added to the system (Fig. 3).

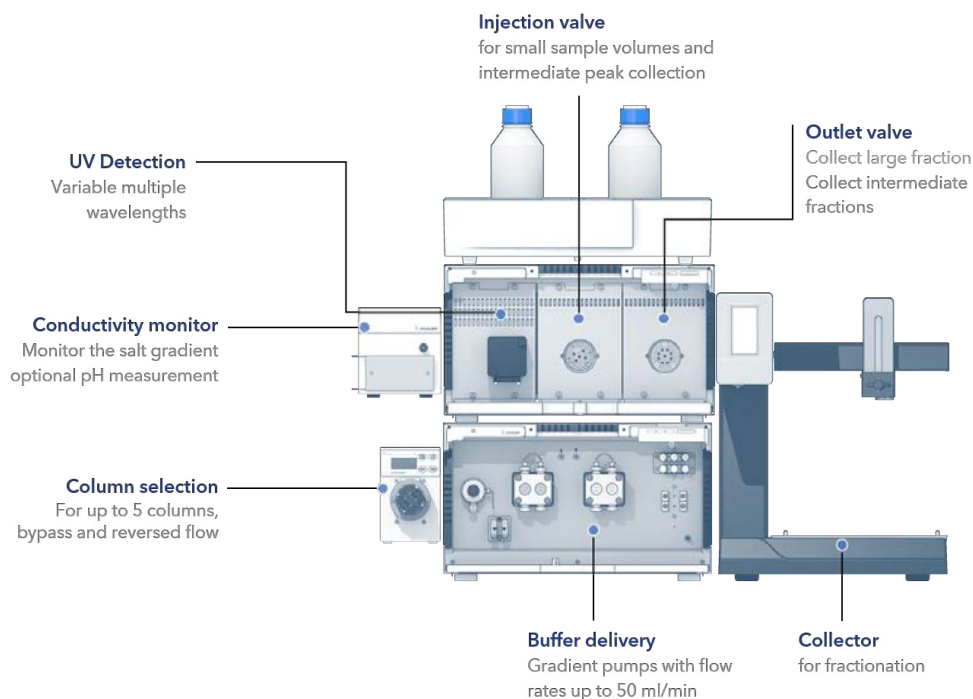


Fig. 3 AZURA Bio Lab system in basic set up: exemplary configuration for automated two step applications.

The reinjection position of the outlet valve is connected to the sample pump inlet of the injection valve so that the syringe port is still accessible for sample injection. The sample is injected via the sample loop

of the injection valve. The first peak is collected in the sample loop of the injection valve as well and reinjected onto the second column (Fig. 4).

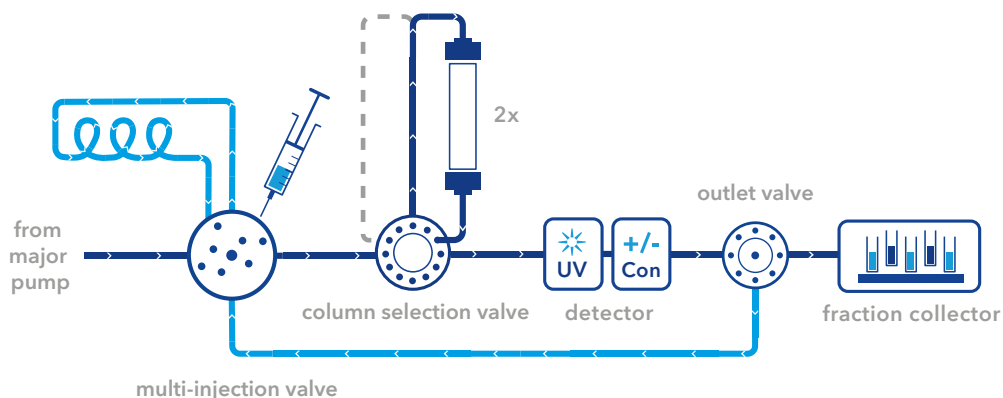


Fig. 4 Flow scheme for the basic set up for two step purification.

# How to optimize your purification?

## Your guide for two step purification - principles and system set up

Consideration: This set up is limited to small sample volumes. The volume of the elution peak of the first column should be equal or even smaller than the injection volume due to diffusion effects that will result in sample loss. To overcome the problem of the small sample volume a variation of this set up is to inject the sample via the major pump. For this set up some additional changes must be implemented. The

filter cartridge of the pressure sensor must be replaced by a dummy and we strongly advise to install an inline filter in front of the column selection valve. You can find more details about this set up including the connection of the capillaries and information about PurityChrom plus method writing in section [Two step purification with the basic set up \(VNT0014\)](#).

### SET UP WITH SAMPLE PUMP

A more advanced set up is the set up with sample pump (Fig. 5). Hereby, the already mentioned column selection and outlet valve, as well as a sample

pump must be added to the Advanced Bio Purification system.

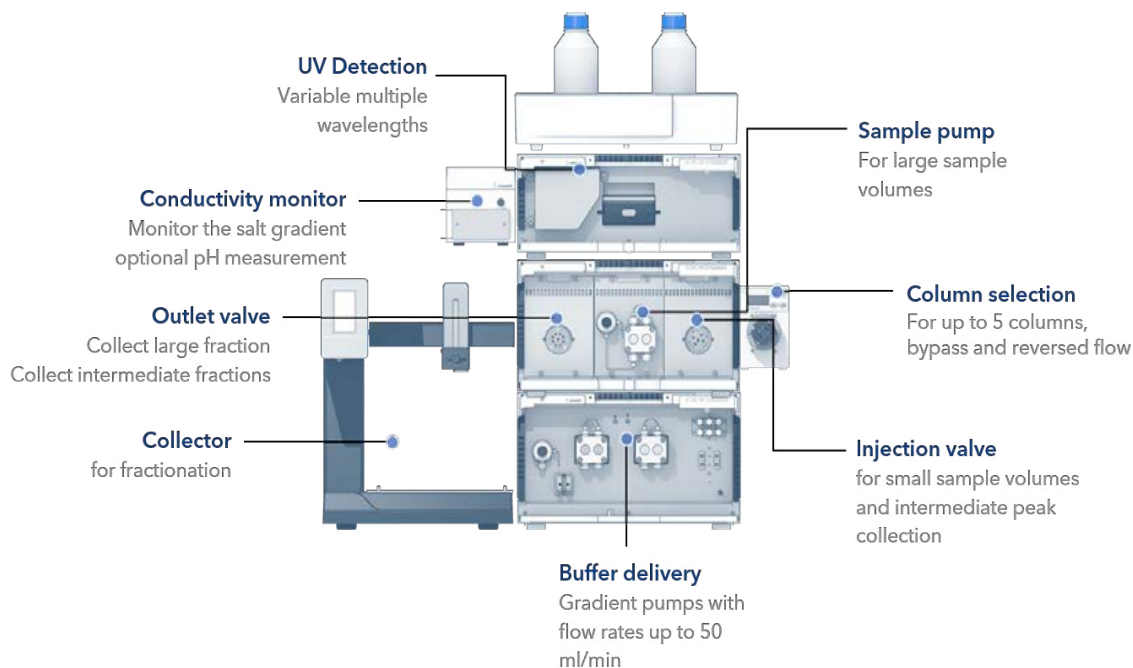


Fig. 5 AZURA Bio Lab system in set up with sample pump: exemplary configuration for automated two step applications.

The sample pump is used to apply the sample onto the column. The peak eluting from the first column is collected in the clean sample loop of the injection valve minimizing the risk of cross contamination during first peak collection. Therefore, the reinjection position of the outlet valve is connected to the syringe port of the injection valve (Fig. 6). This set up allows the loading

of large sample volumes. The injection of small sample volumes is not supported. You can find more details about this set up including the connection of the capillaries and information about PurityChrom plus method writing in section [Two step purification with the sample pump set up \(VTN0015\)](#).



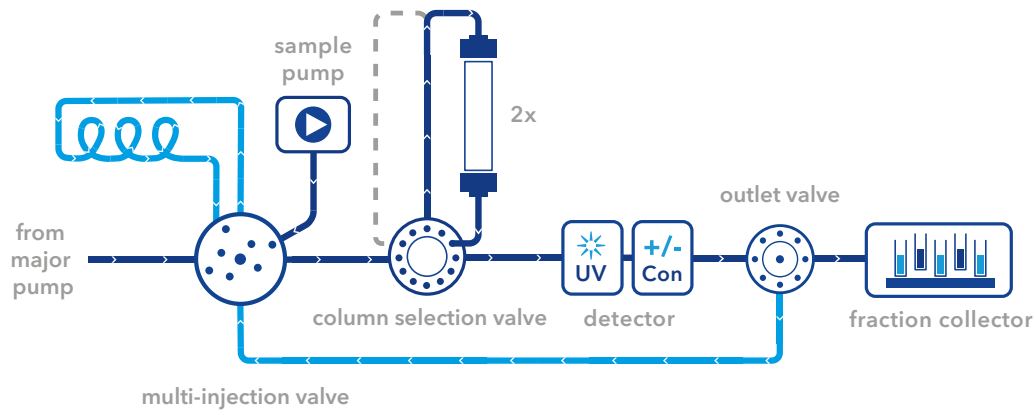


Fig. 6 Flow scheme for the sample pump set up for two step purification.

Tab. 2 Detailed overview of system set up

System	Basic	Sample pump	With loop valve	
Injection via	Sample loop of injection valve	Major pump	Sample pump	Loop valve via injection valve
Collection of first peak	Sample loop of injection valve via sample pump inlet.	Sample loop of injection valve via syringe port	Sample loop of injection valve via syringe port	Loop valve via sample pump inlet of injection valve
Benefits	Free syringe port	Free syringe port	Large sample volumes	Multipurpose (injection)
	Easiest set up	Large sample volumes No extra sample pump needed	Loading of sample via sample pump (minimized cross contamination)	Minimized risk of cross contamination
Limitations	Sample loop is used for injection and collection	Major pump used for injection	Syringe port is used for first peak collection in sample loop	Large delay volume
	Volume of the first elution peak should be equal or smaller than the injection volume		Small sample volumes not supported	Not optimal for small scale purification
System changes		Column selection and outlet valve		
	Change filter of pressure sensor	Sample pump	Sample loop valve	
	Inline filter			

# How to optimize your purification?

## Your guide for two step purification - principles and system set up

### WHICH SET UP SHOULD I USE?

All set ups have their benefits and limitations. The easiest and cost-attractive set up is the basic set up. Only a few changes need to be included in the system. The drawback is that this set up is restricted to small sample volume and that the sample volume and the first elution peak should be in the same volume range. The limitation with the small sample volume can be overcome by using the major pump for sample

injection. This bears the risk of cross contamination as the sample passes the mixing chamber. From our experience for most of our customers this was not a problem and did not affect their purification. Nevertheless, if you are frequently applying large sample volumes, we recommend using the sample pump set up. For better clarity we put together pros and cons of the different set up in **Tab. 2**.

### ARE THERE OTHER OPTIONS POSSIBLE? CAN I DO MULTI STEP PURIFICATION?

Of course, additional set ups are possible. One option for example is to include an additional loop valve used for sample application and the collection of the peaks. With this set up multiple two step purifications could be started in a row without manual interaction or even multi step purifications are possible. Please

keep in mind that this set up will increase the delay volume of your system and complexity of the application. The methods should be well established to ensure excellent purification results. If you have specific ideas, please contact our sales team to discuss your purification challenge.

## TIPPS AND TRICKS FOR TWO STEP PURIFICATION

**Know your method!** For good results and a successful two step purification, the methods should be well established to ensure excellent purification results. You should know the elution volume/peak of the first purification to guarantee that the first peak is stored in an appropriate vessel. A vessel that is too small will result in sample loss as some parts of the sample is transported to the waste. A vessel too big will result in sample dilution, which can affect the second purification step. An option for medium up to high sample volumes is the use of variable sample loop. These variable sample loops can be emptied completely or partially as well as filled completely or partially. This allows you to work very flexible and easily switch between different sample sizes.

**Use automatic sample loading!** For sample loading by a pump, an air sensor can be used to detect the end of your sample. This protects the column from damage by running dry and supports more importantly automatic sample loading. Upon air detection, various functions can be programmed. In the case of automatic sample loading, once air is detected, the software will continue with column washing and elution.

**Measure the pressure!** Use pressure control that allows you to determine the pressure difference over your column bed. The first pressure sensor measures the pressure before the column, while the second sensor measures the pressure after the column. The software PurityChrom® automatically calculates the pressure difference over the media bed. If the pressure differential value (DP) exceeds the preset limit during the run, either the run pauses or another action is applied. Thus, you can protect your valuable columns and media from overpressure.

## ADDITIONAL DEVICES

Tab. 3 List of additional devices

Device	Description	Article No.
Outlet valve in an ASM2.2L or stand alone	Smart valve drive with RFID technology VU 4.1 valve drive for V 4.1 valves, stand alone	<a href="#">AWA01XA</a>
	Universal valve drive for ASM 2.2L, Assistant module VU 4.1 for valves V 4.1	<a href="#">EWA04</a>
	Biocompatible multiposition valve with 8 Ports, 1/16"	<a href="#">AVS34CE</a>
Filter cartridge	Filter cartridge for pump P 6.1L, high capacity, 2 µm titanium filter, 60 µl volume	<a href="#">A9661</a>
Dummy filter cartridge	Empty cartridge, inline filter alternative	<a href="#">A9652</a>
Inline filter	Inline filter, PEEK/Titanium, 1/16", biocompatible, 10 µm	<a href="#">A3379</a>
	Replacement Frits for inline filter, PEEK/Titanium, biocompatible, 10 µm	<a href="#">A3379-1</a>
Sample pump in an ASM2.2L or stand alone	AZURA P4.1S	
	Compact pump with 50 bar pressure sensor, 50 ml/min ceramic pump head for ASM 2.2L	<a href="#">DPG12FB</a>
	Compact pump with 50 bar pressure sensor, 10 ml/min ceramic pump head for ASM 2.2L	<a href="#">DPG12EB</a>
	Compact pump with pressure sensor and 50 ml/min ceramic pump head, stand alone	<a href="#">APG20FB</a>
	Compact pump with pressure sensor and 10 ml/min ceramic pump head, stand alone	<a href="#">APG20EB</a>
Column selection valve/ Loop valve	Smart valve drive with RFID technology VU 4.1 valve drive for V 4.1 valves, stand alone	<a href="#">AWA01XA</a>
	Biocompatible column selection/sample loop selection valve, for 5 columns/sample loops and 1 bypass, reverse flow, 12 ports, 1/16", 50 bar	<a href="#">AVZ52CE</a>
Air sensor	Air sensor for 1/8" tubing	<a href="#">A70093</a>
Pressure control	Pressure control set for pressure difference determination	<a href="#">AZG10</a>

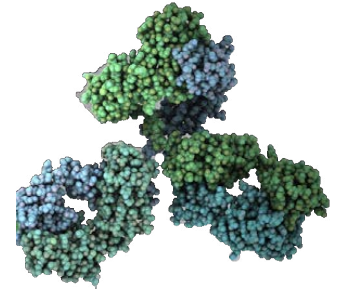
## RELATED KNAUER APPLICATIONS

[VTN0014](#) - Two step purification with a basic set up

[VTN0015](#) - Two step purification with the sample pump set up

# Two step purification with a basic set up

Ulrike Krop, Kate Monks; applications@knauer.net  
 KNAUER Wissenschaftliche Geräte GmbH, Hegauer Weg 38, 14163 Berlin; www.knauer.net.



## WHAT IS TWO STEP PURIFICATION?

Two step purification is a special multicolumn chromatography solution. Two independent methods, each with their associated specific column, are used to realize the purification of the target molecule without manual interference. The principle here is that the protein sample is applied on the first column. During elution of the protein, the protein peak is detected triggering the collection of the eluted protein in a storage loop or storage vessel/container. The protein is then automatically applied on the second column to further enhance the quality and or purity of the purified protein. Several system set ups can be used to automate the purification. In this TechNote a Two step purification with a basic set up is discussed.

## BASIC SYSTEM SET UP: WHAT DO I NEED?

In the basic set up a Lab standard KNAUER Multi Method FPLC system for all biochromatography methods is adapted. Next to the column selection valve and the outlet valve no other components must be added to the system (Fig. 1).

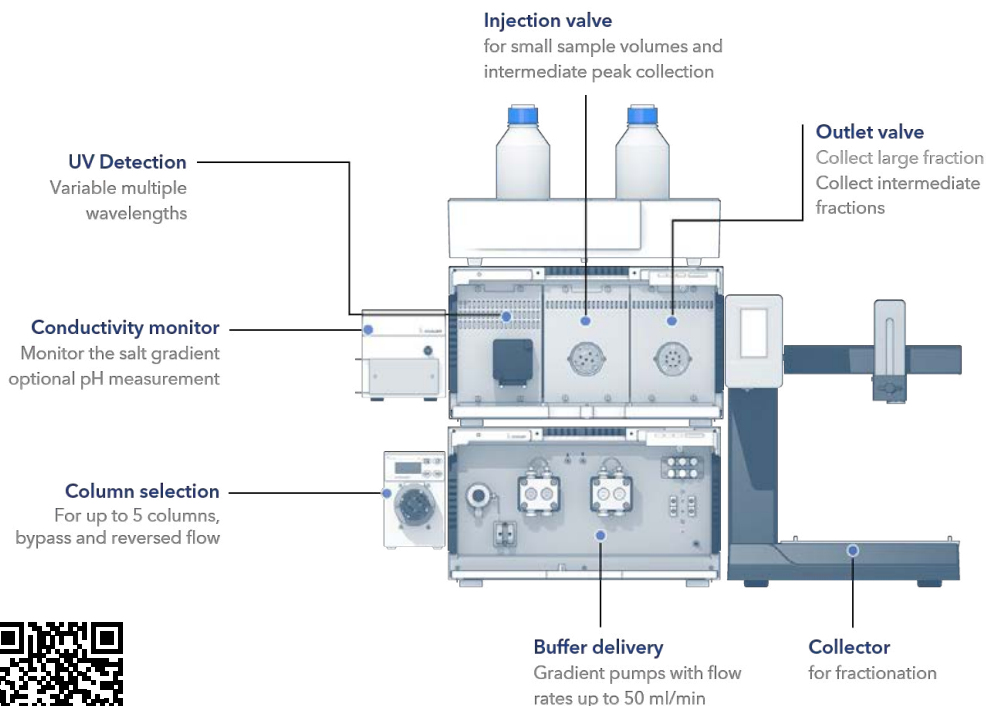


Fig. 1 AZURA Bio Lab system in basic set up: Exemplary configuration for automated two step applications.



Additional Information

# Two step purification with a basic set up

In the basic two step set up the sample is injected via the sample loop of the injection valve. The first peak is collected as well in the sample loop of the injection valve and redirected to the second column. This set

up is limited to small sample volumes. The volume of the elution peak of the first column should be equal or even smaller than the injection volume due to diffusion effects that will result in sample loss (Fig. 2).

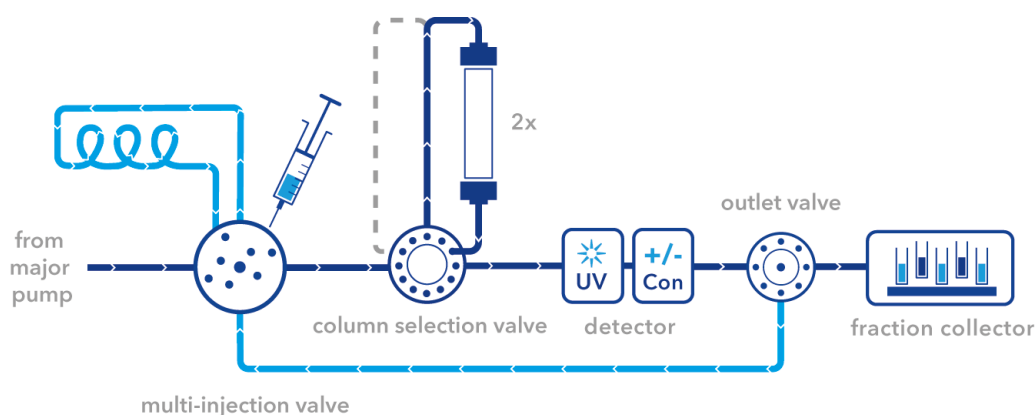


Fig. 2 Flow scheme for the basic set up for two step purification.

The column selection valve is placed between the multi-injection valve and the UV detector. The column outlet port (Col) of the multi-injection valve is connected via the PEEK capillary with the inlet port (IN) of the

column selection valve. The outlet port (OUT) is the connected to the UV detector flow cell which in turn is connected to the conductivity monitor. The columns are installed according to Fig. 3.

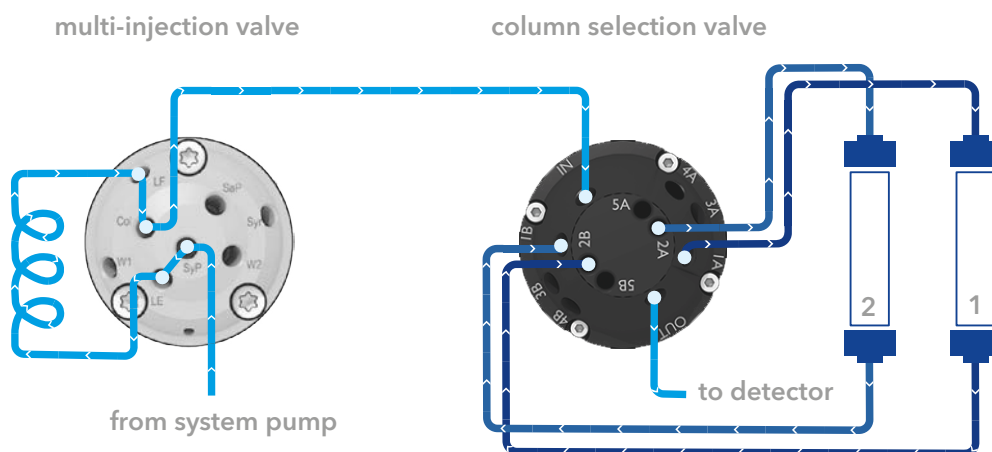


Fig. 3 Connection of the column selection valve.

The outlet valve is placed between the conductivity monitor and the fraction collector. The conductivity monitor is connected via the PEEK capillary with the middle port of the outlet valve. Port 1 of the outlet valve goes by default to the fraction collector or waste

container. Port 3 to 8 can be used for the collection of large fractions. Port 2 (reinjection) of the outlet valve is connected to the sample pump port (SaP) of the multi-injection valve (Fig. 4) The syringe port is still accessible for sample injection.

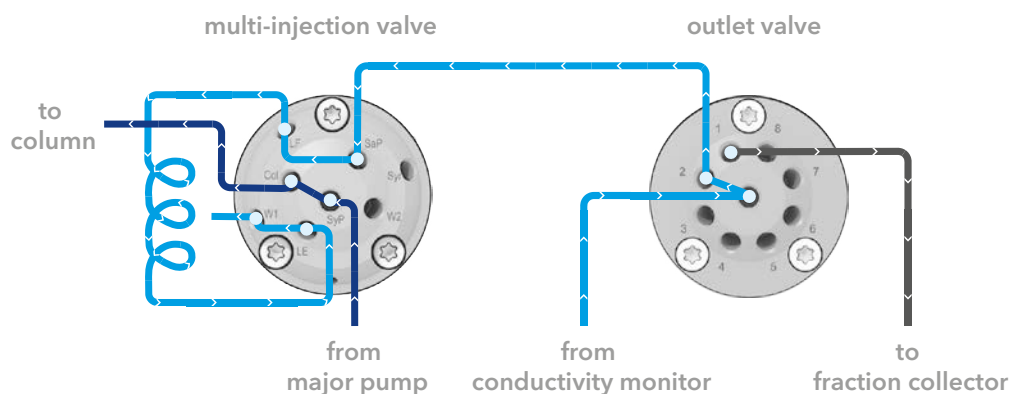


Fig. 4 Connection of the outlet valve.

The set up is, due to the use of the same sample loop for injection and reinjection, limited to small sample volumes. To overcome the problem of the small sample volume a variation of this set up is to inject the sample via the major pump. For this set up some additional changes must be implemented. The filter cartridge of the pressure sensor must be replaced by

a dummy. Please follow the manual for exchanging the pressure filter. When exchanging the pressure filter, we strongly advise to install an inline filter in front of the column selection valve (Fig. 3). The filters frits of the inline filter should be cleaned or replaced from time to time. Additionally, the sample should be filtered via a 0,45 µm filter before injection.

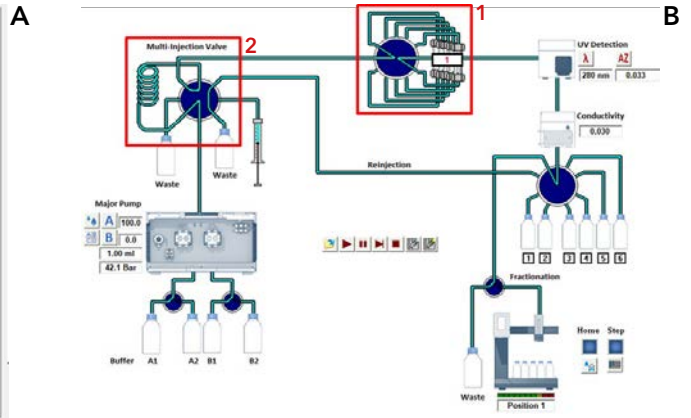
## HOW TO WRITE A METHOD

In the following section we will describe how to write an exemplary method for two step purification with PurityChrom. See also our Checklist: „Creating methods in PurityChrom®“ in the [PurityChrom Installation Information \(V2655A\)](#). In our example in the first step a 1 ml ion exchange column and in the second step a 5 ml desalting column was used. A 2 ml sample loop was used for sample injection and intermediate peak parking. Two separate methods were written for the

two columns. First, important aspects of the ion exchange method are highlighted for the time control file (Fig. 5 to 7A) and the changes in the flow are depicted in the flow scheme/visualization (Fig. 5 to 7B). Make sure to choose the correct column in the beginning of the method (Fig. 5, 1). The sample is inserted in the manual load configuration of the multi-injection valve. During injection, the multi-injection valve switches to the inject position (Fig. 5, 2).

# Two step purification with a basic set up

Volume [ml]	Function	Parameter
0.00	Valve Position	Injection Valve = Manual Load
0.00	Valve Position	Outlet Valve = Waste
0.00	Valve Position	Column Selection Valve = Column 1
0.00	Valve Position	Fraction Collector = Waste
0.00	Composition Major Pump	100.0 , 0.0
0.00	Flowrate Major Pump	1.00 ml/min Constant Flow
0.02	UV Autozero	
0.02	Start Chromatogram	Channel 1,2,P ( 500 ms )
0.02	Valve Position	Injection Valve = Inject
5.00	Composition Major Pump	100.0 , 0.0
5.00	Valve Position	Injection Valve = Manual Load
10.00	Threshold	5.00 ml / 60.00 mAU
15.00	Composition Major Pump	60.0 , 40.0
15.00	Stop all	

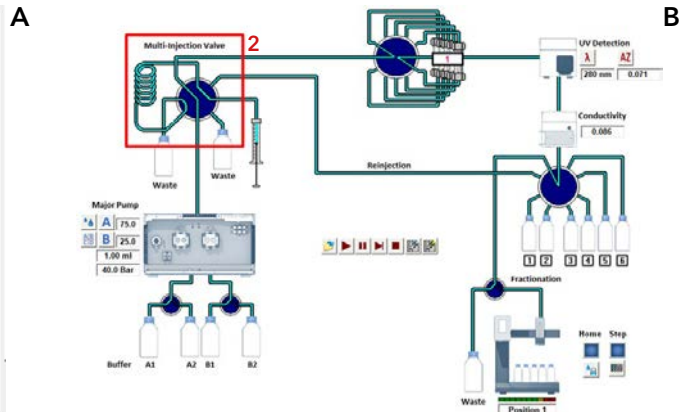


**Fig. 5** Ion exchange method during injection of sample Time control file of ion exchange method (A). Visualization of AZURA Bio Lab system in basic set up (B).

After the sample injection and an isocratic washing step, the elution starts after 5 ml with beginning of the gradient (Fig. 6A, 1). At this time point the

multi-injection valve should be switched back to the manual load position (Fig. 6, 2).

Volume [ml]	Function	Parameter
0.00	Valve Position	Injection Valve = Manual Load
0.00	Valve Position	Outlet Valve = Waste
0.00	Valve Position	Column Selection Valve = Column 1
0.00	Valve Position	Fraction Collector = Waste
0.00	Composition Major Pump	100.0 , 0.0
0.00	Flowrate Major Pump	1.00 ml/min Constant Flow
0.02	UV Autozero	
0.02	Start Chromatogram	Channel 1,2,P ( 500 ms )
0.02	Valve Position	Injection Valve = Inject
5.00	Composition Major Pump	100.0 , 0.0
5.00	Valve Position	Injection Valve = Manual Load
10.00	Threshold	5.00 ml / 60.00 mAU
15.00	Composition Major Pump	60.0 , 40.0
15.00	Stop all	



**Fig. 6** Ion exchange method during gradient elution. Time control file of ion exchange method (A). Visualization of AZURA Bio Lab system in basic set up (B).

To recognize the eluting peak a threshold function is used. The threshold is active during the gradient elution (Fig. 7A). Once a peak above 60 mAU is detected (threshold over event), this peak is rerouted to the sample loop. For this the outlet valve switches to the reinjection position (Fig. 7, 2) and the multi-injection valve switches to pump load (SaP Load) (Fig. 7, 1). If the peak is below 60 mAU (threshold under event) the

outlet valve switches back to waste and the multi-injection valve back to manual load. Please keep in mind to program an execution delay in the PurityChrom set up for the delay volume between the UV detector and the outlet valve. At the end of the run purified protein is stored in the injection loop and can be further purified via the second column in the next step without manual interference.



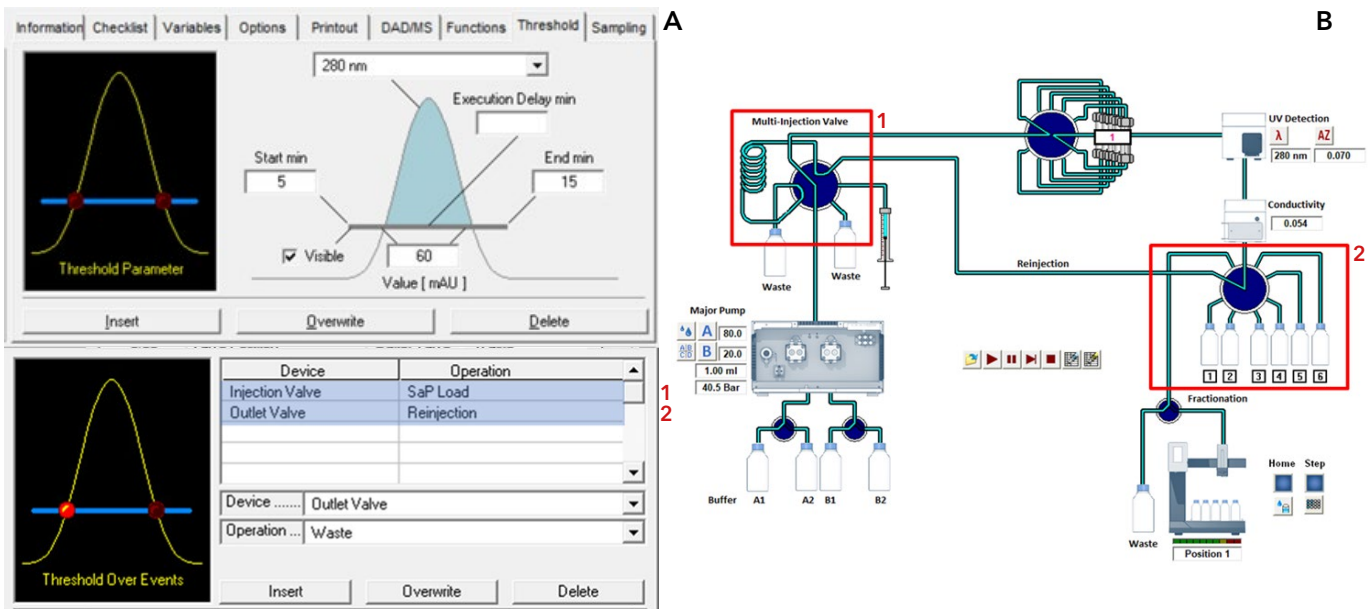


Fig. 7 Ion exchange method during collection of the intermediate peak. Time control file of ion exchange method definition of threshold function (A). Visualization of AZURA Bio Lab system in basic set up (B).

The time control file for the second method (Desalting) is shown in Fig. 8A and the flow scheme/visualization is shown in Fig. 8B. Here, the buffer (Fig. 8, 1) and the column changes (Fig. 8, 2). To inject the intermediate peak onto the desalting column the multi-injection

valve is set to the inject position (Fig. 8, 3). The eluting peak is precisely fractionated with the help of the threshold function (Fig. 8, 4) using the fraction collector. At the end of the two step purification run the protein is purified and collected in small fractions.

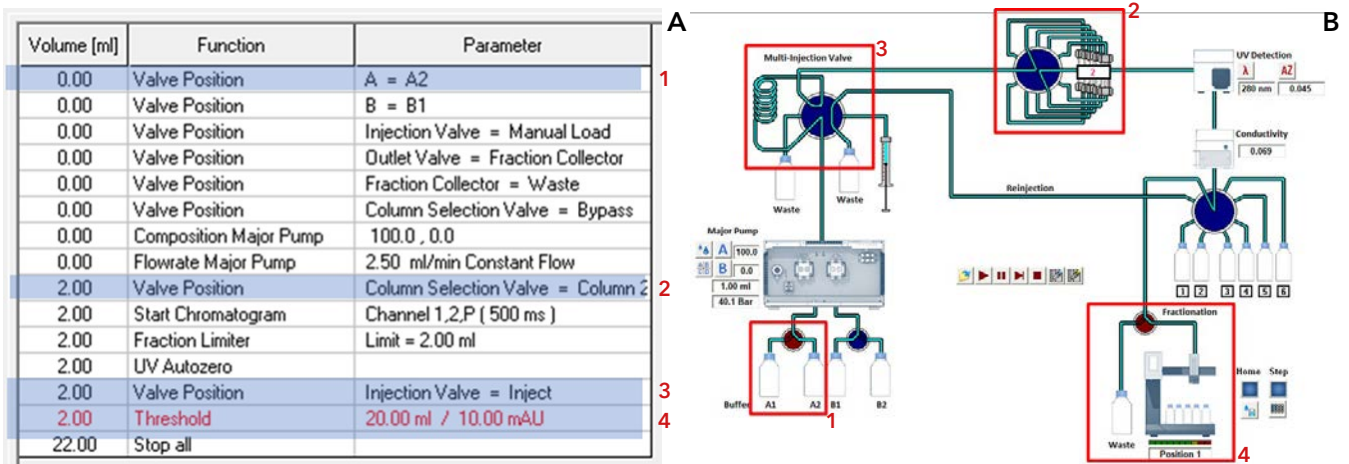


Fig. 8 Desalting method. Time control file of desalting method (A). Visualization of AZURA Bio Lab system in basic set up (B).

To run both methods one after the other a sequence table should be used (Fig. 9).

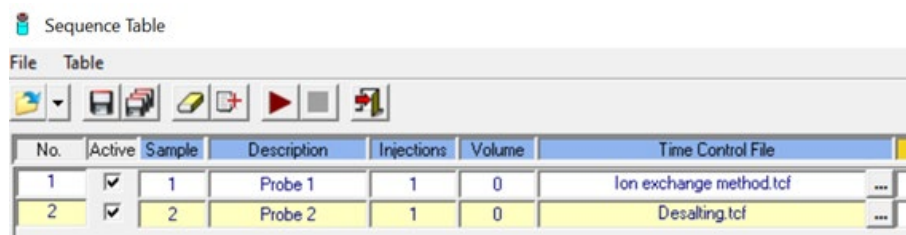


Fig.9 Sequence table.

## ADDITIONAL DEVICES

Tab.1 List of additional devices

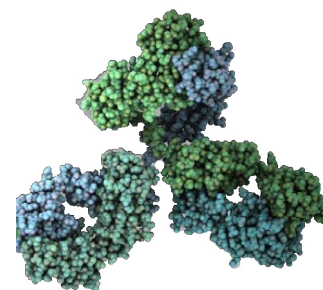
Device	Description	Article No.
Outlet valve in an ASM2.2L or stand alone	Smart valve drive with RFID-technology VU 4.1 valve drive for V 4.1 valves, stand alone	<a href="#">AWA01XA</a>
	Universal valve drive for ASM 2.2L, assistant module VU 4.1 for valves V 4.1	<a href="#">EWA04</a>
	Biocompatible multiposition valve with 8 Ports, 1/16"	<a href="#">AVS34CE</a>
Filter cartridge	Filter cartridge for pump P 6.1L, high capacity, 2 µm titanium filter, 60 µl volume	<a href="#">A9661</a>
Dummy filter cartridge	Empty cartridge, inline filter alternative	<a href="#">A9652</a>
Inline filter	Inline Filter, PEEK/Titanium, 1/16", biocompatible, 10 µm	<a href="#">A3379</a>
	Replacement Frits for inline filter, PEEK/titanium, biocompatible, 10 µm	<a href="#">A3379-1</a>
Column selection valve	Smart valve drive with RFID technology VU 4.1 valve drive for V 4.1 valves, stand alone	<a href="#">AWA01XA</a>
	Biocompatible column selection/sample loop selection valve, for 5 columns/sample loops and 1 bypass, reverse flow, 12 ports, 1/16", 50 bar	<a href="#">AVZ52CE</a>

## RELATED KNAUER APPLICATIONS

[VTN0013](#) - How to optimize your purification? Your guide for two step purification - principles and system set up

[VTN0015](#) - Two step purification with the sample pump set up

# Two step purification with the sample pump set up



Ulrike Krop, Kate Monks; applications@knauer.net

KNAUER Wissenschaftliche Geräte GmbH, Hegauer Weg 38, 14163 Berlin; www.knauer.net.

## WHAT IS TWO STEP PURIFICATION?

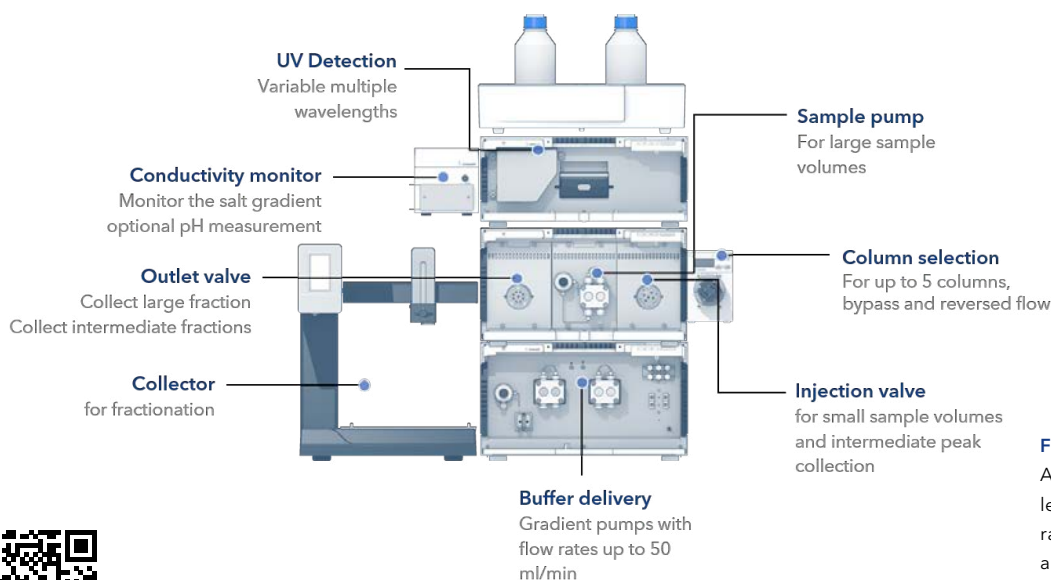
Two step purification is a special multicolumn chromatography solution. Two independent methods, each with their associated specific column, are used to realize the purification of the target molecule without manual interference. The principle here is that the protein sample is applied on the first column. During elution of the protein, the protein peak is detected

triggering the collection of the eluted protein in a storage loop or storage vessel/container. The protein is then automatically applied on the second column to further enhance the quality and or purity of the purified protein. Several system set ups can be used to automate the purification. In this TechNote a two step purification with the sample pump set up is discussed.

## SET UP WITH SAMPLE PUMP: WHAT DO YOU NEED?

In the sample pump set up a Lab standard KNAUER Multi Method FPLC system for all Bio-Chromatography methods is adapted. Hereby, a column selection valve, an outlet valve, as well as a sample pump must

be added to the system. Alternatively, the AZURA Bio Lab System Advanced with an outlet valve can be used (**Fig. 1, Tab. 3**).



**Fig. 1** AZURA Bio Lab System Advanced in set up with sample pump: exemplary configuration for automated two step applications.



# Two step purification with the sample pump set up

The sample pump is used to apply the sample on the first column. The peak eluting from the first column is collected in the sample loop of the injection valve and redirected to the second column. This set ups allows the loading of large sample volumes and minimizes

the risk of cross contamination during first peak collection because the sample loop is only used for the eluting peak. The injection of small sample volumes is not supported (Fig. 2).

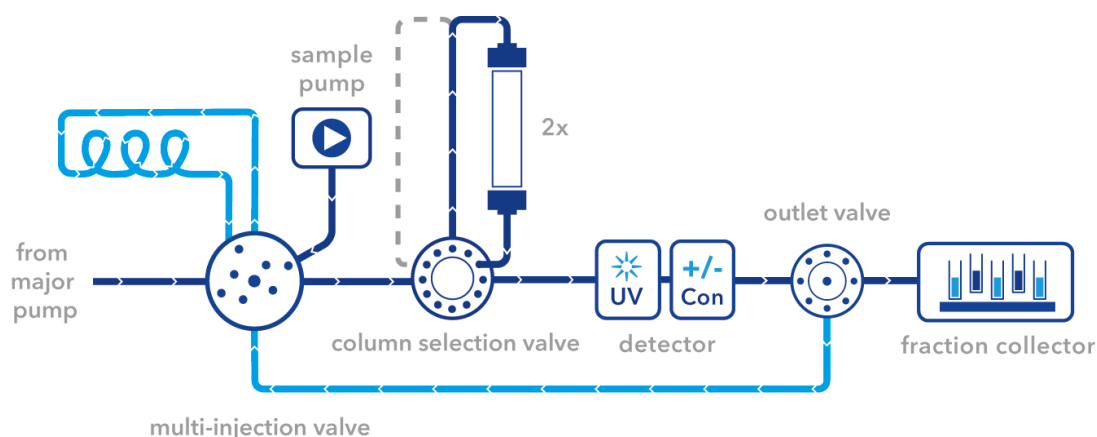


Fig. 2 Flow scheme for the sample pump set up for two step purification.

The column selection valve is placed between the multi-injection valve and the UV detector. The column outlet port (Col) of the multi-injection valve is connected via the PEEK capillary with the inlet port (IN) of

the column selection valve. The outlet port (OUT) is connected to the UV detector flow cell, which in turn is connected to the conductivity monitor. The columns are installed according to Fig. 3.

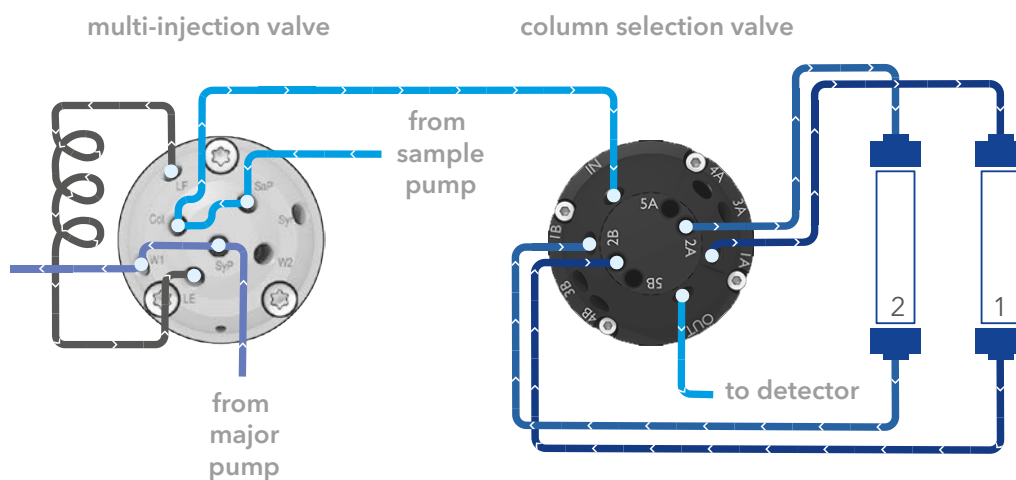


Fig. 3 Connection of the column selection valve.

The outlet valve is placed between the conductivity monitor and the fraction collector. The conductivity monitor is connected via the PEEK capillary with the middle port of the outlet valve. Port 1 of the outlet valve goes by default to the fraction collector or waste

container. Port 3 to 8 can be used for the collection of large fractions. Port 2 (rejection) of the outlet valve is connected to the syringe port (Syr) of the multi-injection valve (Fig. 4) The syringe port is no longer accessible for sample injection.

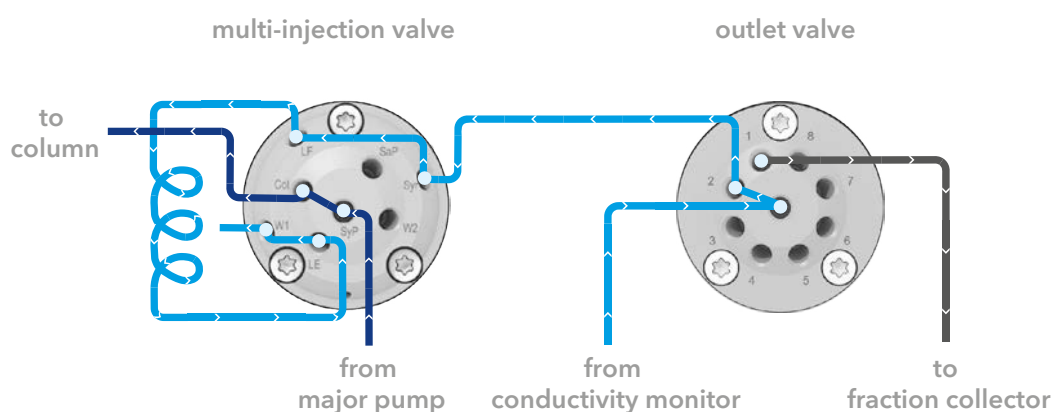


Fig. 4 Connection of the outlet valve.

## HOW TO WRITE A METHOD

In the following section we will describe how to write an exemplary method for two step purification with PurityChrom. See also our checklist: „Creating methods in PurityChrom®“ in the [PurityChrom Installation Information \(V2655A\)](#). In our example, in the first step a 1 ml ion exchange column and in the second step a 5 ml desalting column was used. The sample pump with an airsenser is used for automatic sample application. A 2 ml sample loop was used for intermediate peak parking. Two separate methods were written for

the two columns. First, important aspects of the ion exchange method with automatic sample application are highlighted for the time control file (Fig. 5A - Fig. 7A) and the changes in the flow are depicted in the flow scheme/visualization (Fig. 5B - Fig. 7B). Make sure to choose the correct column in the beginning of the method (Fig. 5, 2) In the first step, the multi-injection valve is still in manual load position to equilibrate the ion exchange column with the major pump (Fig. 5, 1).

# Two step purification with the sample pump set up

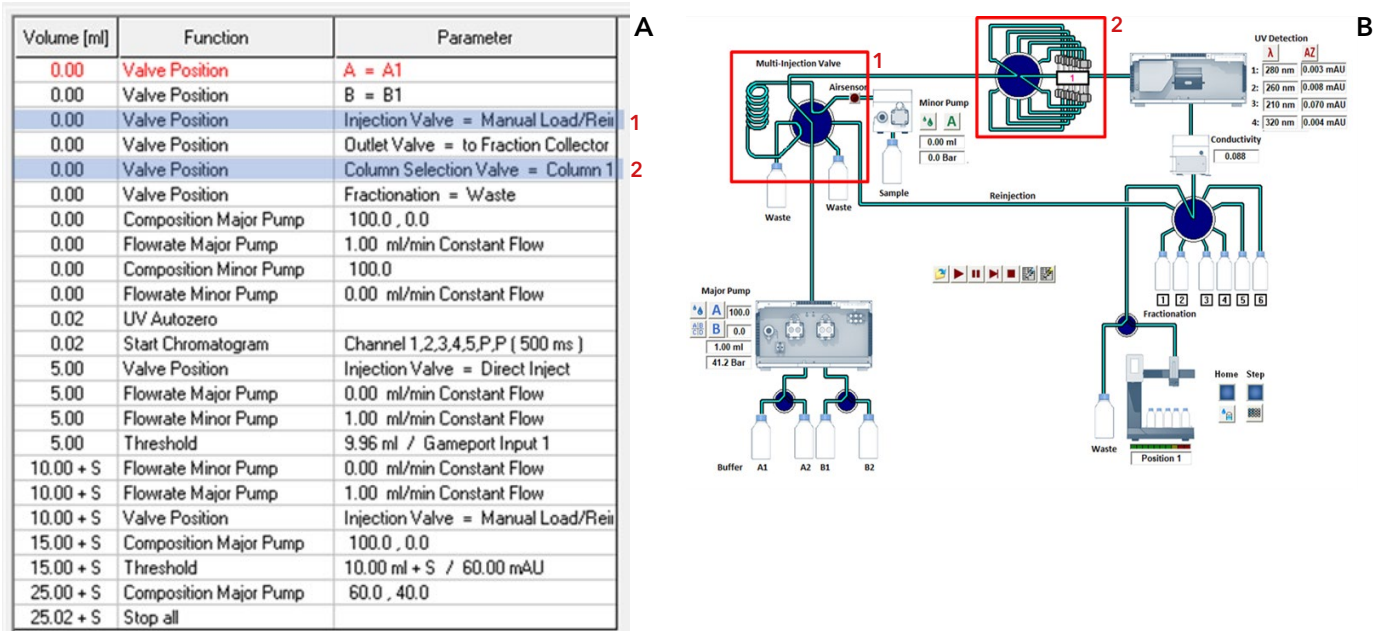


Fig. 5 Ion exchange method during column equilibration. Time control file of ion exchange method (A). Visualization of AZURA Bio Lab system in set up with sample pump (B).

After equilibrating the column the sample is automatically applied via the sample (minor) pump. Therefore, the multi-injection valve switches to direct inject

(Fig. 6, 1) and the flow of the sample pump is set to 1 ml/min (Fig. 6, 2).

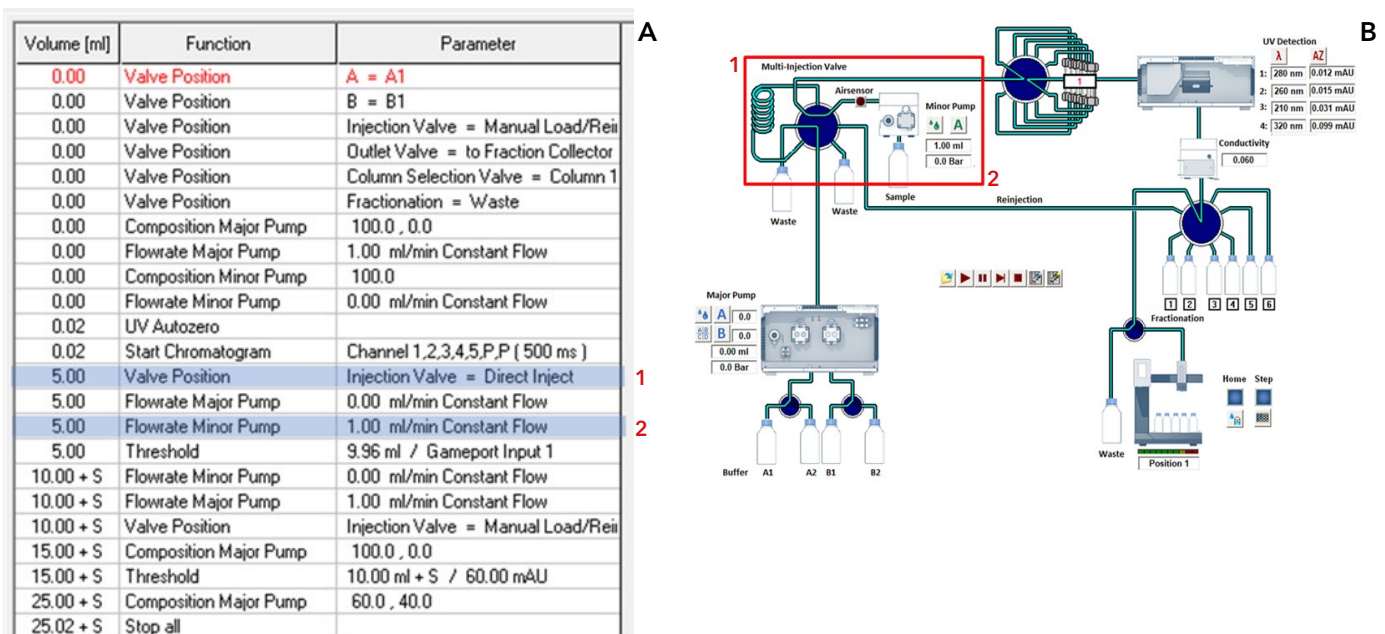


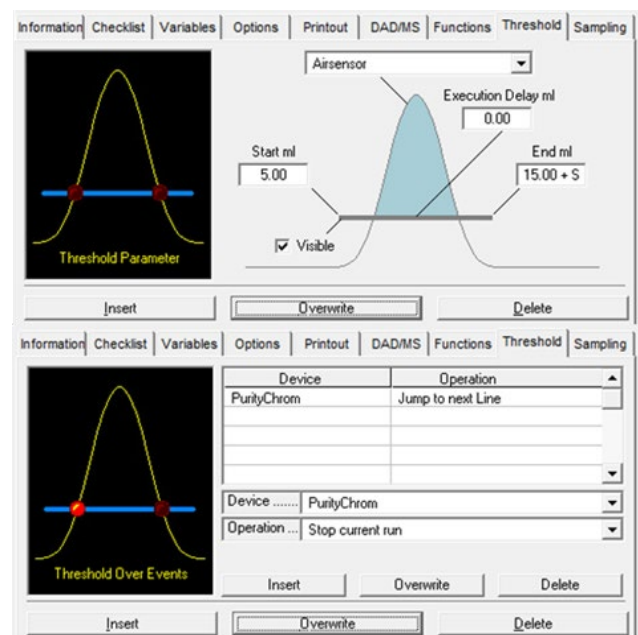
Fig. 6 Ion exchange method during automatic sample injection. Time control file of ion exchange method (A). Visualization of AZURA Bio Lab system in set up with sample pump (B).

During automatic sample injection the threshold function is used to detect air via the air sensor and then automatically moves to the next step in the method (Fig. 7). The variable time shift was used to design the method more flexible and to adjust the sample

amount accordingly. For more information please check the chapter "Air sensor usage for sample application with the sample pump (with chromatogram)" in the [AZURA Air Sensor Supplement \(V6879\)](#).

Volume [ml]	Function	Parameter
0.00	Valve Position	A = A1
0.00	Valve Position	B = B1
0.00	Valve Position	Injection Valve = Manual Load/Reil
0.00	Valve Position	Outlet Valve = to Fraction Collector
0.00	Valve Position	Column Selection Valve = Column 1
0.00	Valve Position	Fractionation = Waste
0.00	Composition Major Pump	100.0 , 0.0
0.00	Flowrate Major Pump	1.00 ml/min Constant Flow
0.00	Composition Minor Pump	100.0
0.00	Flowrate Minor Pump	0.00 ml/min Constant Flow
0.02	UV Autozero	
0.02	Start Chromatogram	Channel 1,2,3,4,5,P,P ( 500 ms )
5.00	Valve Position	Injection Valve = Direct Inject
5.00	Flowrate Major Pump	0.00 ml/min Constant Flow
5.00	Flowrate Minor Pump	1.00 ml/min Constant Flow
5.00	Threshold	9.96 ml / Gateport Input 1
10.00 + S	Flowrate Minor Pump	0.00 ml/min Constant Flow
10.00 + S	Flowrate Major Pump	1.00 ml/min Constant Flow
10.00 + S	Valve Position	Injection Valve = Manual Load/Reil
15.00 + S	Composition Major Pump	100.0 , 0.0
15.00 + S	Threshold	10.00 ml + S / 60.00 mAU
25.00 + S	Composition Major Pump	60.0 , 40.0
25.02 + S	Stop all	

A



B

Fig. 7 Ion exchange method airsensor detection during automatic sample injection with Time control file of ion exchange method (A) and threshold function (B).

# Two step purification with the sample pump set up

After the sample injection and an isocratic washing step (Fig. 8A, 1), the elution starts after 5ml with the beginning of the gradient (Fig. 8A, 2). At this time

point the multi-injection valve should be switched back to the manual load position (Fig. 8, 3).

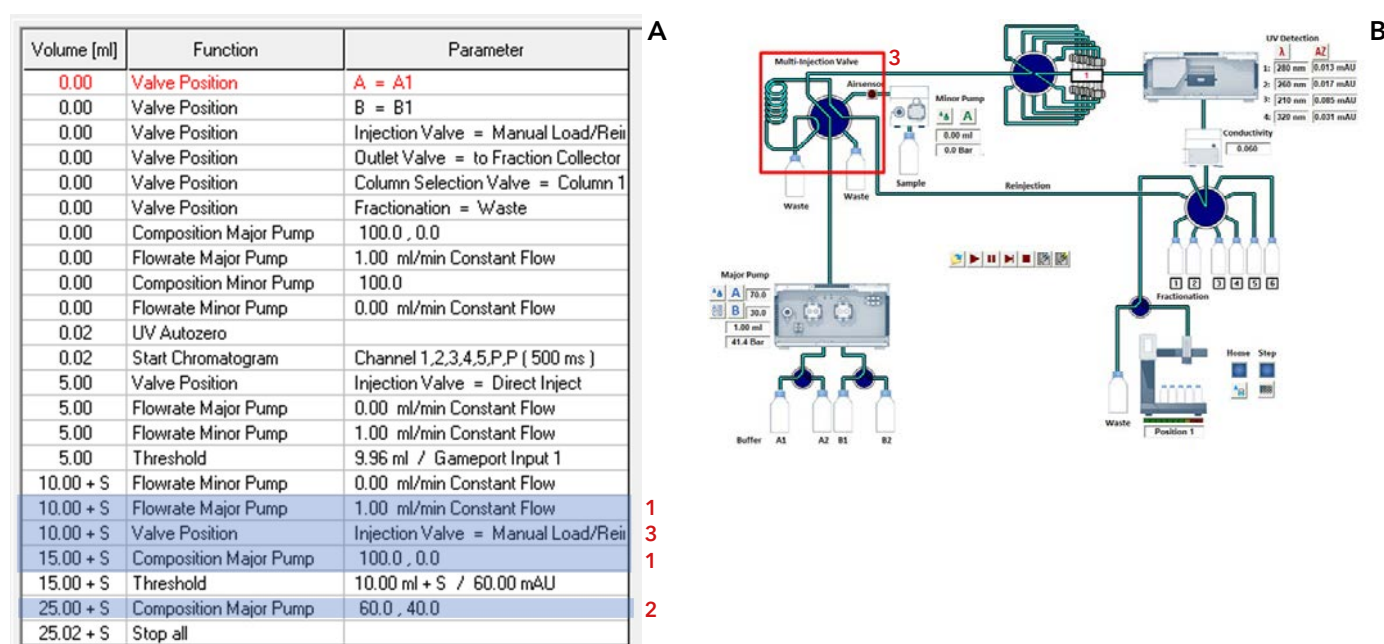


Fig. 8 Ion exchange method during gradient elution. Time control file of ion exchange method (A). Visualization of AZURA Bio Lab system in set up with sample pump (B).

To recognize the eluting peak a threshold function is used. The threshold is active during the gradient elution (Fig. 9A). Once a peak above 60 mAU is detected (threshold over event), this peak is rerouted to the sample loop. For this the outlet valve switches to the reinjection position (Fig. 9, 1). The multi-injection

valve was already in the manual load/reinjection position. If the peak is below 60 mAU (threshold under event) the outlet valve switches back to waste. Please keep in mind to program an execution delay in the PurityChrom set up for the delay volume between the UV detector and the outlet valve.



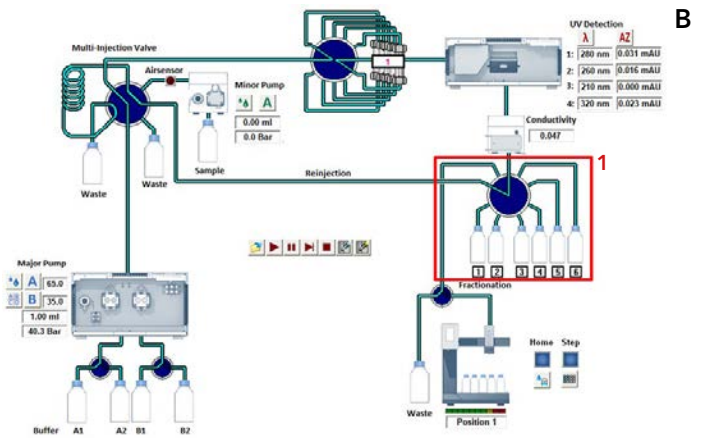
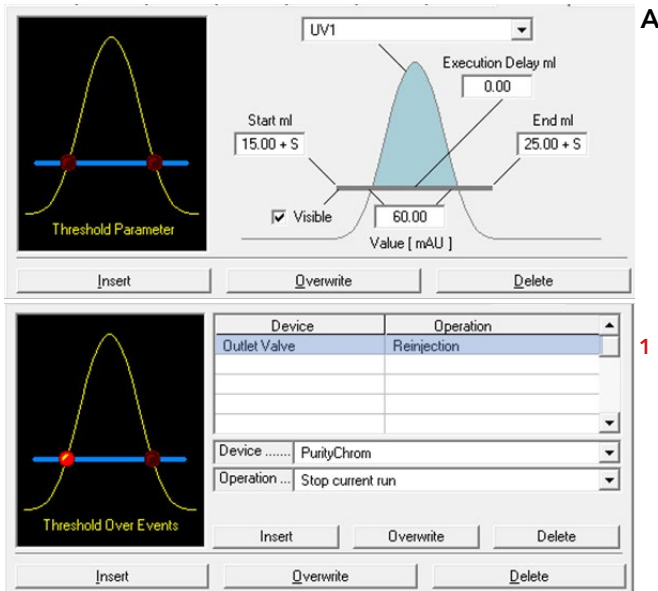


Fig. 9 Ion exchange method during collection of the intermediate peak. Time control file of ion exchange method definition of threshold function (A). Visualization of AZURA Bio Lab system in set up with sample pump (B).

At the end of the run purified protein is stored in the injection loop and can be further purified via the second column in the next step without manual interference. The time control file for the second method (Desalting) is shown in Fig. 10A and the flow scheme/ visualization is shown in Fig. 10B. Here, the buffer (Fig. 10, 1) and the column changes (Fig. 10, 2).

To inject the intermediate peak onto the desalting column the multi-injection valve is set to the inject position (Fig. 10, 3). The eluting peak is precisely fractionated with the help of the threshold function (Fig. 10, 4) using the fraction collector. At the end of the two step purification run the protein is purified and collected in small fractions.

Volume [ml]	Function	Parameter
0.00	Valve Position	A = A2
0.00	Valve Position	B = B1
0.00	Valve Position	Injection Valve = Manual Load/Reinjection
0.00	Valve Position	Outlet Valve = to Fraction Collector
0.00	Valve Position	Column Selection Valve = Bypass
0.00	Valve Position	Fractionation = Waste
0.00	Composition Major Pump	100.0 , 0.0
0.00	Flowrate Major Pump	2.50 ml/min Constant Flow
2.00	Start Chromatogram	Channel 1,2,3,4,5,P,P ( 500 ms )
2.00	UV Autozero	
2.00	Valve Position	Injection Valve = Inject
2.00	Fraction Limiter	Limit = 2.00 ml
2.00	Threshold	20.00 ml / 10.00 mAU
2.00	Valve Position	Column Selection Valve = Column 2
22.00	Stop all	

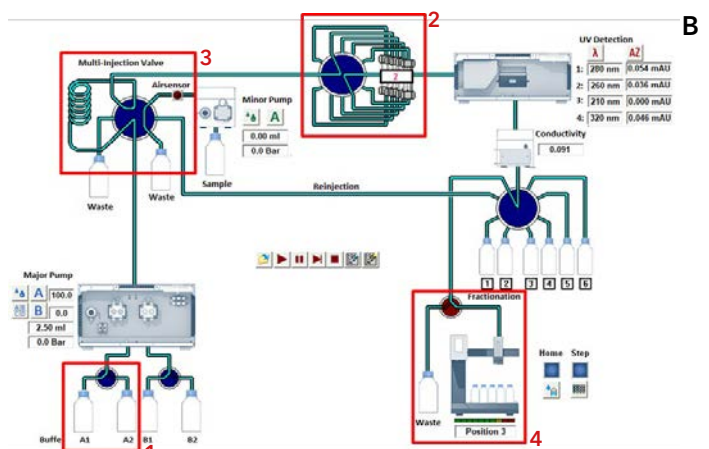


Fig. 10 Desalting method. Time control file of desalting method (A). Visualization of AZURA Bio Lab system in set up with sample pump (B).

To run both methods one after the other a sequence table should be used (Fig. 11).

No.	Active	Sample	Description	Injections	Volume	Time Control File
1	<input checked="" type="checkbox"/>	1	Probe 1	1	0	Ion exchange method.tcf
2	<input checked="" type="checkbox"/>	2	Probe 2	1	0	Desalting.tcf

Fig. 11 Sequence table.

## ADDITIONAL DEVICES

Tab. 1 List of additional devices

Device	Description	Article No.
Outlet valve in an ASM2.2L or stand alone	Smart valve drive with RFID-technology VU 4.1 valve drive for V 4.1 valves, stand alone	<a href="#">AWA01XA</a>
	Universal valve drive for ASM 2.2L, assistant module VU 4.1 for valves V 4.1	<a href="#">EWA04</a>
	Biocompatible multiposition valve with 8 Ports, 1/16"	<a href="#">AVS34CE</a>
Filter cartridge	Filter cartridge for pump P 6.1L, high capacity, 2 µm titanium filter, 60 µl volume	<a href="#">A9661</a>
Dummy filter cartridge	Empty cartridge, inline filter alternative	<a href="#">A9652</a>
Inline filter	Inline Filter, PEEK/Titanium, 1/16", biocompatible, 10 µm	<a href="#">A3379</a>
	Replacement Frits for inline filter, PEEK/titanium, biocompatible, 10 µm	<a href="#">A3379-1</a>
Column selection valve	Smart valve drive with RFID technology VU 4.1 valve drive for V 4.1 valves, stand alone	<a href="#">AWA01XA</a>
	Biocompatible column selection/sample loop selection valve, for 5 columns/sample loops and 1 bypass, reverse flow, 12 ports, 1/16", 50 bar	<a href="#">AVZ52CE</a>

## RELATED KNAUER APPLICATIONS

[VTN0013](#) - How to optimize your purification? Your guide for two step purification - principles and system set up

[VTN0014](#) - Two step purification with a basic set up

# KNAUER

## Applications and Academy

With profound application knowledge of analytical and preparative HPLC, FPLC, SMB, and Osmometry our team is at your service around

the world. Our experts are pleased to receive your inquiries and requests, and will offer attractive customized solutions.



### **Application development**

Proof of concept and support in selecting a HPLC / FPLC, SMB, or Osmometry method for your task

### **Method transfer & optimization**

Transfer your methods to one of our HPLC systems or make your analyses faster, more efficient and cost effective

### **Rent an expert**

Rent an expert for assistance in your lab

### **Academy**

HPLC and FPLC trainings as well as specialized courses for beginners and experienced users



## **Not found what you are looking for?**

Contact us with your requirements - together we will find a solution.

[applications@knauer.net](mailto:applications@knauer.net) • [www.knauer.net](http://www.knauer.net)